

# MULTIMODE DIGITAL BOTTOM PORT SISONIC™ MICROPHONE

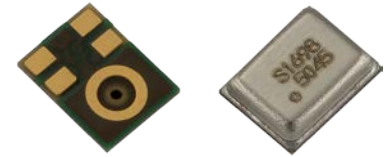

The SPH0644LM4H-1 is a miniature, high-performance, low power, bottom port silicon digital microphone with a single bit PDM output. Using Knowles' proven high performance SiSonic™ MEMS technology, the SPH0644LM4H-1 consists of an acoustic sensor, a low noise input buffer, and a sigma-delta modulator. These devices are suitable for applications such as cellphones, smart phones, laptop computers, sensors, digital still cameras, portable music recorders, and other portable electronic devices where excellent wideband audio performance and RF immunity are required. In addition, the SPH0644LM4H-1 offers multiple performance modes.

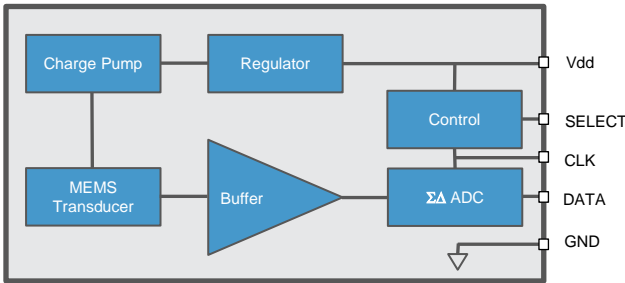

## PRODUCT FEATURES

- Low Distortion /High AOP
- High SNR
- Low Current Consumption in Low-Power Mode
- Flat Frequency Response
- High Drive Capability
- RF Shielded
- Bottom Port
- Sensitivity Matching
- Supports Dual Multiplexed Channels
- Multiple Performance Modes (Sleep, Low-Power, Normal)
- Ultra-Stable Performance
- Standard SMD Reflow
- Omnidirectional
- LGA Package

## ABSOLUTE MAXIMUM RATINGS

Table 1: Absolute Maximum Ratings

Parameter	Absolute Maximum Rating	Units
Vdd to Ground	-0.3, +5.0	V
DATA, CLOCK, SELECT to Ground	-0.3, +5.0	V
Input Current	±5	mA
Short Circuit to/from DATA	Indefinite to Ground or Vdd	sec
Storage Temperature	-40 to +100	°C
Operating Temperature	-40 to +100	°C

Stresses exceeding these "Absolute Maximum Ratings" may cause permanent damage to the device. These are stress ratings only. Functional operation at these or any other conditions beyond those indicated under "Acoustic & Electrical Specifications" is not implied. Exposure beyond those indicated under "Acoustic & Electrical Specifications" for extended periods may affect device reliability.

## TYPICAL APPLICATIONS

- Portable Electronics
- Cellphones
- Laptop Computers
- Tablets
- Digital Still Cameras
- Portable Music Recorders



## ACOUSTIC & ELECTRICAL SPECIFICATIONS<sup>1</sup>

Table 2: General Microphone Specifications

Test Conditions: 23 ±2°C, 55±20% R.H., Vdd=1.8 V, Tedge ≤ 3ns, unless otherwise indicated

Parameter	Symbol	Conditions	Min	Typ	Max	Units
Supply Voltage	Vdd		1.6	1.8	3.6	V
Low Frequency Rolloff	LFRO	-3dB relative to 1 kHz	-	35	-	Hz
High Frequency Flatness		+3dB relative to 1 kHz	-	14	-	kHz
Resonant Frequency Peak	Fres	Free Field response	-	28	-	kHz
DC Offset		Fullscale = ±100	-	0	-	% FS
Directivity			Omnidirectional			
Polarity		Increasing sound pressure	Increasing density of 1's			
Data Format			½ Cycle PDM			
Sensitivity Drop		Vdd(min) ≤ Vdd ≤ Vdd(max)	-	-	±0.25	dB
Clock Input Capacitance	Cin		-	5	-	pF
Data Output Capacitance	Cout		-	19	-	pF
Data Output Load	Cload		-	-	140	pF
SELECT (high)			Vdd-0.2	-	3.6	V
SELECT (low)			-0.3	-	0.2	V
Short Circuit Current	Isc	Grounded DATA pin	1	-	20	mA
Fall-asleep Time <sup>3,4</sup>		Fclock < 250kHz	-	-	10	ms
Wake-up Time <sup>3,5</sup>		Fclock ≥ 500kHz	-	-	35	ms
Startup Time <sup>3</sup>		Powered Down → Active, S within 1 dB of final value	-	-	50	ms
Time to First Data Bit <sup>6</sup>		Time from valid Vdd and CLK until the first logical bit is driven on the DATA line. The output is tristate until First Data Bit.	-	30	-	ms
Mode-Change Time <sup>3, 6</sup>		Low Power Mode ↔ Normal Mode	-	-	16	ms

Table 3: Normal Mode

Test Conditions: 23 ±2°C, 55±20% R.H., Vdd=1.8 V, Fclock = 2.4 MHz (D.C. = 50%), Tedge ≤ 3ns, SELECT grounded, no load, unless otherwise indicated

Parameter	Symbol	Conditions	Min	Typ	Max	Units
Supply Current <sup>2</sup>	Idd	Fclock = 1.536 MHz	-	685	850	μA
		Fclock = 2.4 MHz	-	900	1100	
		Fclock = 3.072 MHz	-	1130	1400	
Sensitivity	S	94 dB SPL @ 1 kHz	-38	-37	-36	dBFS
Signal to Noise Ratio	SNR	94 dB SPL @ 1 kHz, A-weighted, Fclock = 1.536 MHz	-	61.5	-	dB(A)
		94 dB SPL @ 1 kHz, A-weighted, Fclock = 2.4 MHz	-	65.5	-	
		94 dB SPL @ 1 kHz, A-weighted, Fclock = 3.072 MHz	-	65.7	-	
Near-Ultrasonic SNR		94 dB SPL, @ 19 kHz, BW = 18.5 - 20.0 kHz	-	75.5	-	dB
Total Harmonic Distortion	THD	94 dB SPL @ 1 kHz	-	0.2	-	%
		115 dB SPL @ 1 kHz	-	1	-	
		1% THD @ 1 kHz, S = typ	-	114.5	-	dB SPL
Acoustic Overload Point	AOP	10% THD @ 1 kHz, S = typ	-	132.5	-	dB SPL
Power Supply Rejection Ratio	PSRR	200 mVpp sinewave @ 1 kHz	-	87	-	dB V/FS
Power Supply Rejection	PSR+N	200 mVpp 7/8 duty cycle rectangular waveform @ 217 Hz, A-weighted, BW = 20 kHz	-	-97	-	dBFS(A)

Table 4: Low-Power Mode

Test Conditions: 23 ±2°C, 55±20% R.H., Vdd=1.8 V, Fclock = 768 kHz (D.C. = 50%), Tedge ≤ 3ns, SELECT grounded, no load, unless otherwise indicated

Parameter	Symbol	Conditions	Min	Typ	Max	Units
Supply Current <sup>2</sup>	Idd		-	255	320	μA
Sensitivity	S	94 dB SPL @ 1 kHz	-22	-21	-20	dBFS
Signal to Noise Ratio	SNR	94 dB SPL @ 1 kHz, A-weighted (BW = 8 kHz)	-	64.5	-	dB(A)
Total Harmonic Distortion	THD	94 dB SPL @ 1 kHz	-	0.2	-	%
		1% THD @ 1 kHz, S = typ	-	113	-	
Acoustic Overload Point	AOP	10% THD @ 1 kHz, S = typ	-	116.5	-	dB SPL
Power Supply Rejection Ratio	PSRR	200 mVpp sinewave @ 1 kHz	-	76	-	dBV/FS
Power Supply Rejection	PSR+N	200 mVpp 7/8 duty cycle rectangular waveform @ 217 Hz, A-weighted, BW = 8 kHz	-	-85	-	dBFS(A)

Table 5: Sleep Mode

Test Conditions: 23 ±2°C, 55±20% R.H., Vdd=1.8 V, Fclock = 0 Hz, SELECT grounded, no load, unless otherwise indicated

Parameter	Symbol	Conditions	Min	Typ	Max	Units
Sleep Current	I <sub>sleep</sub>		-	50	-	µA

<sup>1</sup> Sensitivity and Supply Current are 100% tested.

<sup>2</sup> I<sub>dd</sub> varies with Clload according to:  $\Delta I_{dd} = 0.5 \cdot V_{dd} \cdot \Delta Cl_{load} \cdot F_{clock}$ .

<sup>3</sup> Valid microphone states are: Powered Down Mode (mic off), Sleep Mode (low current, DATA = high-Z, fast startup), Low-Power Mode (low clock speed) and Normal Mode.

<sup>4</sup> Time from Fclock < 280 kHz to I<sub>sleep</sub> specification is met when transitioning from Active Mode to Sleep Mode.

<sup>5</sup> Time from Fclock ≥ 500 kHz to all applicable specifications are met when transitioning from Sleep Mode to Active Mode.

<sup>6</sup> Audio is temporarily muted during the transition between any microphone state.

Table 6: Digital Interface

Test Conditions: 23 ±2°C, 55±20% R.H., Vdd=1.8 V, Tedge ≤ 3ns, unless otherwise indicated

Parameter	Symbol	Conditions	Min	Typ	Max	Units
Logic Input High <sup>7</sup>	V <sub>ih</sub>		0.65xV <sub>dd</sub>	-	3.6	V
Logic Input Low <sup>7</sup>	V <sub>il</sub>		-0.3	-	0.35xV <sub>dd</sub>	V
Logic Output High <sup>7</sup>	V <sub>oh</sub>	I <sub>OUT</sub> = 2 mA	V <sub>dd</sub> -0.45	-	V <sub>dd</sub>	V
Logic Output Low <sup>7</sup>	V <sub>ol</sub>	I <sub>OUT</sub> = 2 mA	0	-	0.45	V
Low→High Threshold <sup>8</sup>	V <sub>l-h</sub>		-	-	0.65xV <sub>dd</sub>	V
High→Low Threshold <sup>8</sup>	V <sub>h-l</sub>		0.35xV <sub>dd</sub>	-	-	V
Hysteresis Width <sup>8</sup>	V <sub>hyst</sub>		0.05xV <sub>dd</sub>	-	0.20xV <sub>dd</sub>	V
Clock Frequency <sup>7</sup>	F <sub>clock</sub>	Sleep Mode	0	-	280	kHz
		Low-Power Mode	500	-	1200	
		Normal Mode	1.4	-	4.8	MHz
Clock Duty Cycle	D.C.		40	50	60	%
Delay Time to Data Line Driven <sup>7</sup>	T <sub>dd</sub>		18	-	35	ns
Delay Time to Valid Data <sup>7</sup>	T <sub>dv</sub>	Max Clload	-	-	100	ns
Delay Time to High Z <sup>7</sup>	T <sub>dz</sub>		5	-	16	ns
Hold Time <sup>7</sup>	T <sub>hold</sub>	T <sub>hold</sub> , as observed by the input device, will be dependent on Clload	5	-	-	ns

<sup>7</sup> See Figure 1: Timing Diagram.

<sup>8</sup> See Figure 2: Hysteresis Diagram.

Figure 1: Timing Diagram

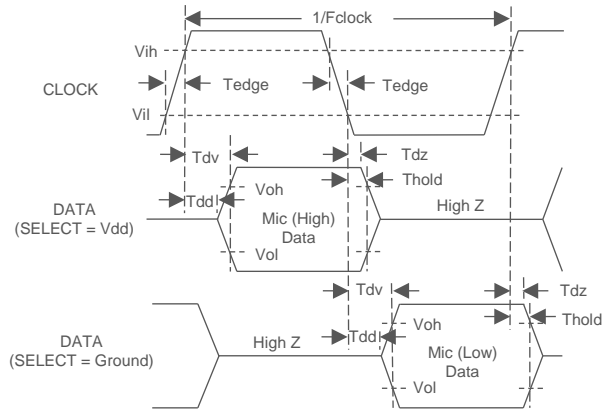

Figure 2: Hysteresis Diagram

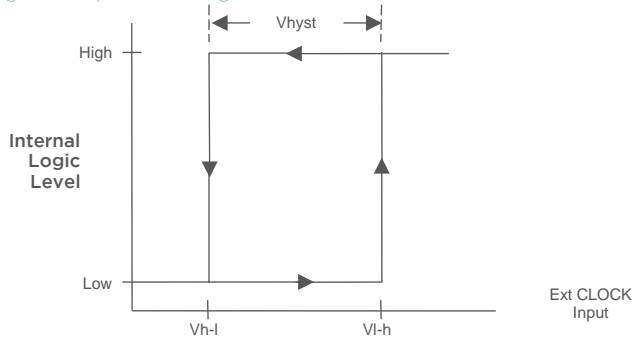

Figure 3: State Diagram

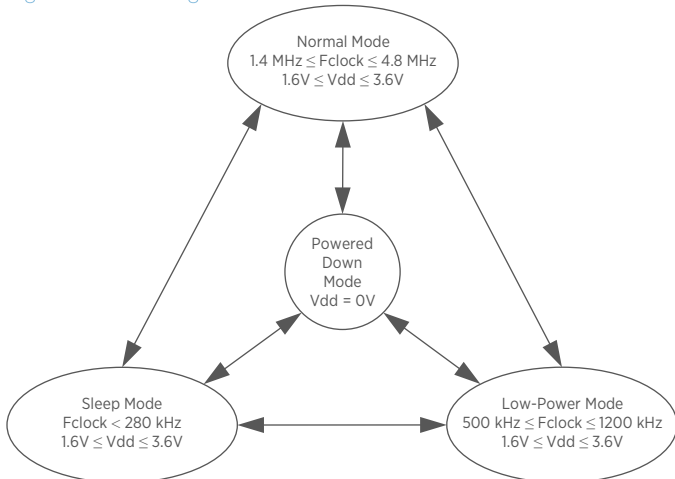
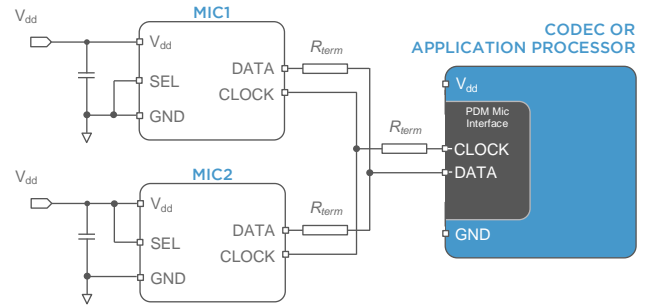

Figure 4: Typical Application Circuit



NOTES:

All Ground pins must be connected to ground.  
Bypass capacitors should be placed next to each V<sub>dd</sub> pin for best performance.  
Capacitors near the microphone should not contain Class 2 dielectrics due to their piezoelectric effect.

Table 7: SELECT Functionality

Microphone	SELECT	Asserts DATA on	Latch DATA on
Mic (High)	V <sub>dd</sub>	CLK rising edge	CLK falling edge
Mic (Low)	Ground	CLK falling edge	CLK rising edge



## PERFORMANCE CURVES

Test Conditions: 23 ±2°C, 55±20% R.H., Vdd=1.8 V, Fclock = 2.4 MHz, SELECT grounded, no load, unless otherwise indicated

Figure 5: Typical Free Field Magnitude and Phase Response

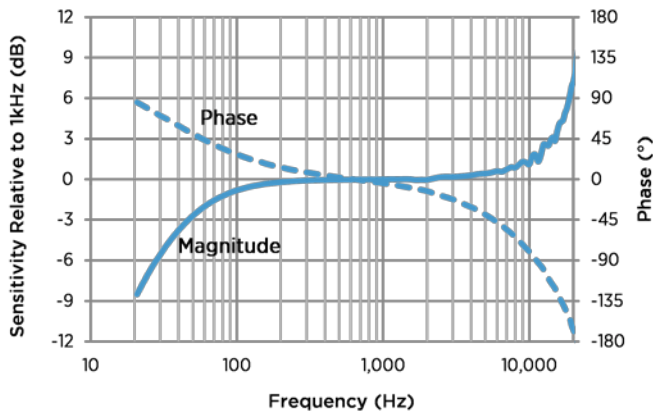

Figure 7: Typical THD vs SPL

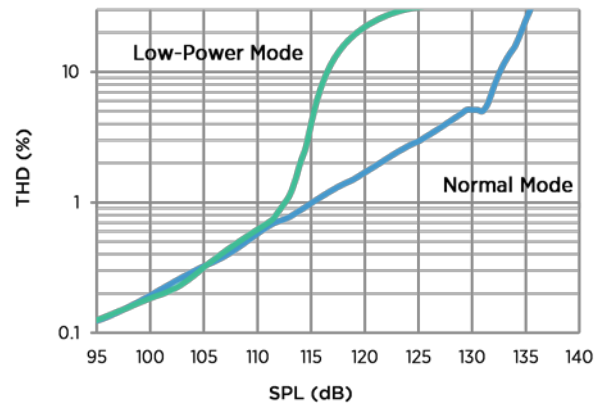

Figure 6: Typical Group Delay

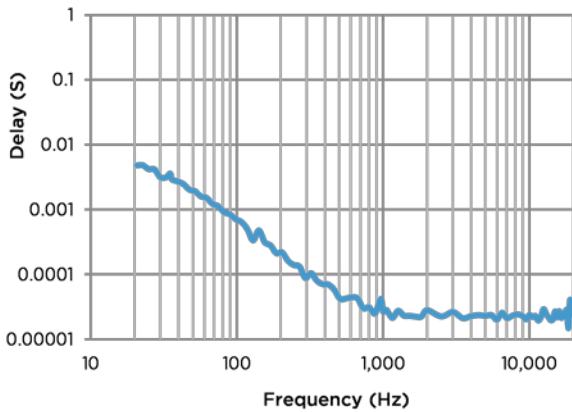

Figure 8: Typical THD vs Frequency

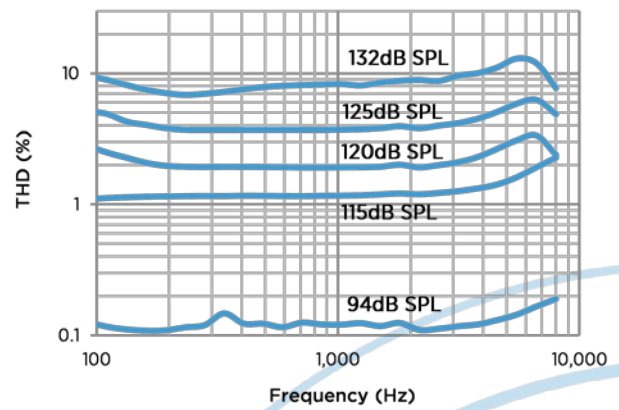

Figure 9: Typical Free Field Ultrasonic Response

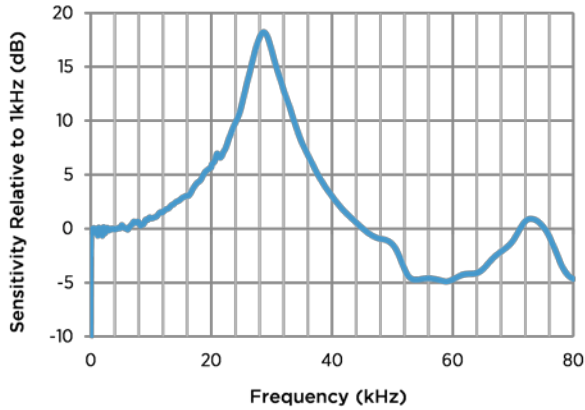

Figure 11: Noise Floor Power Spectral Density

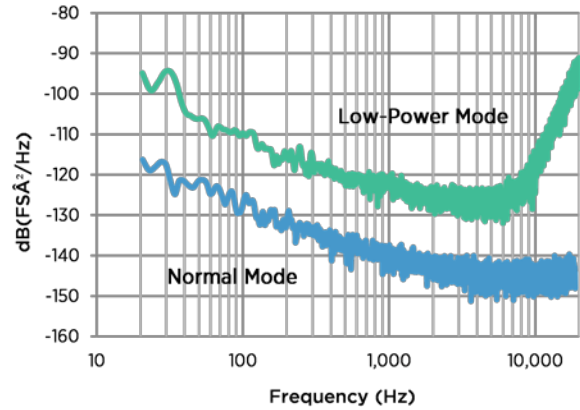

Figure 10: Typical I<sub>dd</sub> vs V<sub>dd</sub>

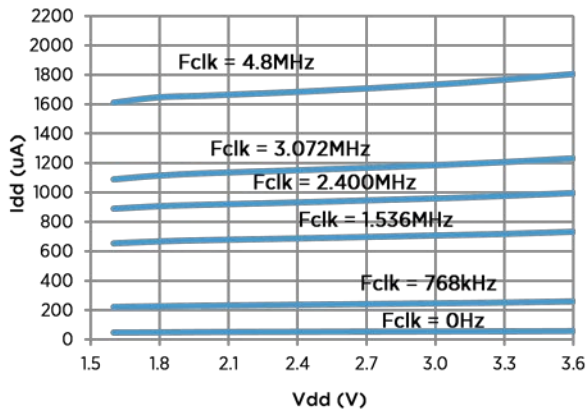
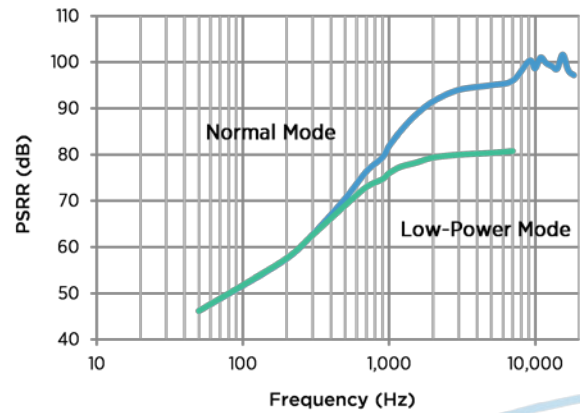
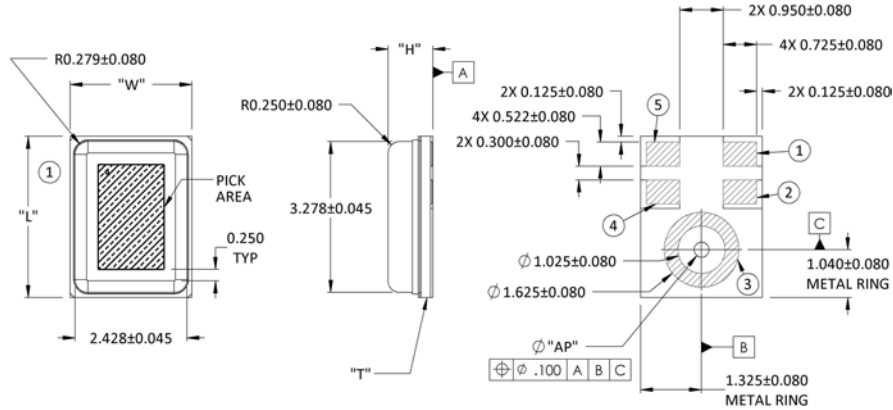

Figure 12: Typical PSRR





## MECHANICAL SPECIFICATIONS



Item	Dimension	Tolerance
Length (L)	3.5	±0.10
Width (W)	2.65	±0.10
Height (H)	0.98	±0.10
Acoustic Port (AP)	Ø0.325	±0.05
PCB Thickness (T)	0.307	±0.05

Pin #	Pin Name	Type	Description
1	DATA	Digital O	PDM Output
2	SELECT	Non-Digital I	Lo/Hi (L/R) Select Connect to Vdd or GND
3	GROUND	Power	Ground
4	CLOCK	Digital I	Clock Input
5	Vdd	Power	Power Supply. Pull low to turn off and do not leave floating.

### Example Land Pattern

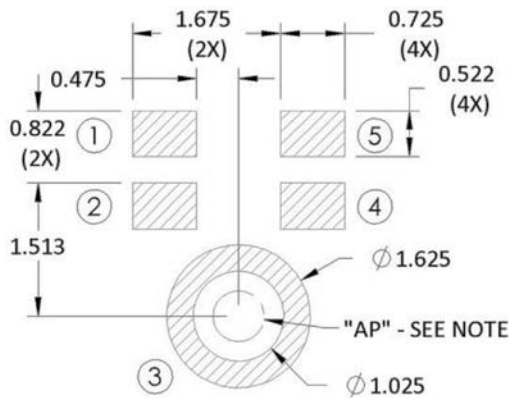

### Example Solder Stencil Pattern

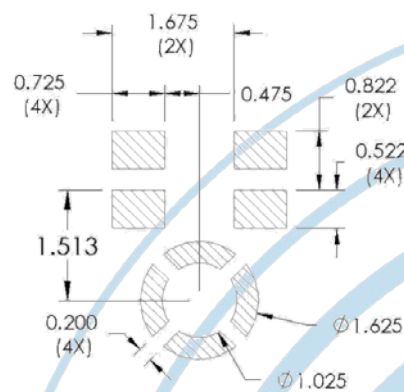

#### NOTES:

Pick Area only extends to 0.25 mm of any edge or hole unless otherwise specified.

Dimensions are in millimeters unless otherwise specified.

Tolerance is ±0.15mm unless otherwise specified

In the acoustic path, the recommended PCB Hole Diameter is  $0.6 \leq D \leq 1.0$ mm, the recommended Gasket Cavity Diameter is  $D \geq 1.0$ mm and the recommended Case Hole Diameter is  $1.0 \leq D \leq 1.5$ mm. Further optimizations based on application should be performed.

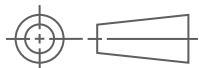



## PACKAGING & MARKING DETAIL

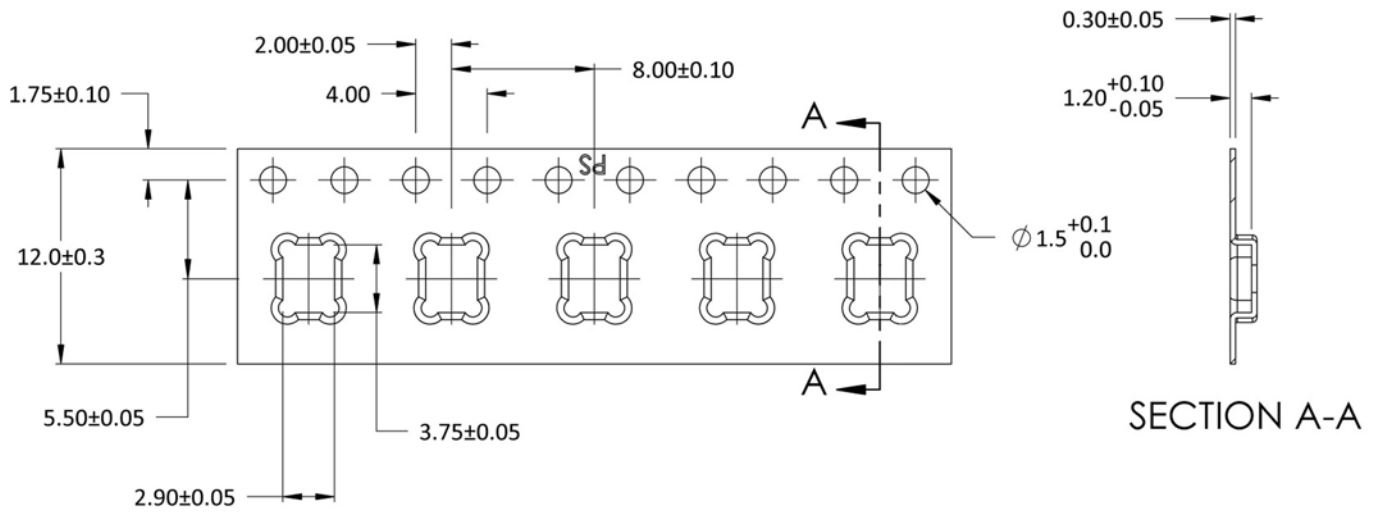

Model Number	Suffix	Reel Diameter	Quantity Per Reel
SPH0644LM4H-1	-8	13"	5900

Component	Surface Resistance (ohms)
Reel	$10^5 - 10^9$
Carrier Tape	$10^5 - 10^9$
Cover Tape	$10^4 - 10^{10}$

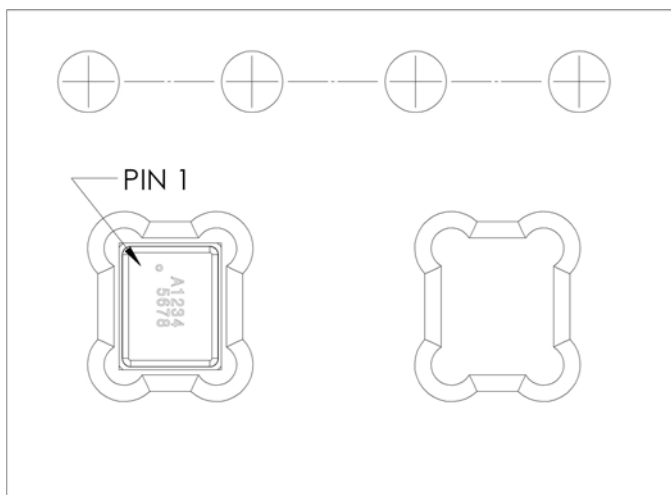

Letter: "o", orientation mark (pin 1)  
 Alpha Character A:  
 "S": Knowles SiSonic™ Production  
 "E": Knowles Engineering Samples  
 "P": Knowles Prototype Samples  
 "12345678":  
 Unique Job Identification Number for product traceability

### NOTES:

Dimensions are in millimeters unless otherwise specified.  
 Vacuum pickup only in the pick area indicated in Mechanical Specifications.  
 Tape & reel per EIA-481.  
 Labels applied directly to reel and external package.  
 Shelf life: Twelve (12) months when devices are stored in the factory-supplied, unopened ESD moisture sensitive bag under the maximum environmental conditions of 30°C, 70% R.H.



## RECOMMENDED REFLOW PROFILE

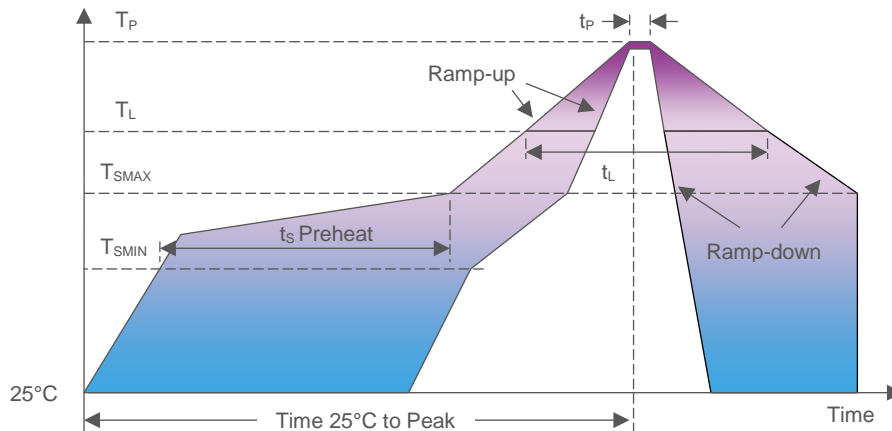

Profile Feature	Pb-Free
Average Ramp-up rate ( $T_{SMAX}$ to $T_P$ )	3°C/second max.
Preheat <ul style="list-style-type: none"> <li>Temperature Min (<math>T_{SMIN}</math>)</li> <li>Temperature Max (<math>T_{SMAX}</math>)</li> <li>Time (<math>T_{SMIN}</math> to <math>T_{SMAX}</math>) (<math>t_s</math>)</li> </ul>	150°C 200°C 60-180 seconds
Time maintained above: <ul style="list-style-type: none"> <li>Temperature (<math>T_L</math>)</li> <li>Time (<math>t_L</math>)</li> </ul>	217°C 60-150 seconds
Peak Temperature ( $T_P$ )	260°C
Time within 5°C of actual Peak Temperature ( $t_p$ )	20-40 seconds
Ramp-down rate ( $T_P$ to $T_{SMAX}$ )	6°C/second max
Time 25°C to Peak Temperature	8 minutes max

### NOTES:

Based on IPC/JDEC J-STD-020 Revision C.

All temperatures refer to topside of the package, measured on the package body surface.

The actual reflow profile used should be optimized based on the reflow requirements of all components, board design, solder paste formulation and reflow equipment used. Details of recommended handling and manufacturing processes can be found in AN25 SMT Manufacturing Guidelines for SiSonic™ Microphones.

### ADDITIONAL NOTES

- MSL (moisture sensitivity level) Class 1.
- Maximum of 3 reflow cycles is recommended.
- In order to minimize device damage:
  - Do not board wash or clean after the reflow process.
  - Do not brush board with or without solvents after the reflow process.
  - Do not directly expose to ultrasonic processing, welding, or cleaning.
  - Do not insert any object in port hole of device at any time.
  - Do not apply over 30 psi of air pressure into the port hole.
  - Do not pull a vacuum over port hole of the microphone.
  - Do not apply a vacuum when repacking into sealed bags at a rate faster than 0.5 atm/sec.



## MATERIALS STATEMENT

Meets the requirements of the European RoHS directive 2011/65/EC as amended.

Meets the requirements of the industry standard IEC 61249-2-21:2003 for halogenated substances and Knowles Green Materials Standards Policy section on Halogen-Free.

Product is Beryllium Free according to limits specified on the Knowles Hazardous Material List (HSL for Products).

Ozone depleting substances are not used in the product or the processes used to make the product, including compounds listed in Annex A, B, and C of the "Montreal Protocol on Substances That Deplete the Ozone Layer."

## RELIABILITY SPECIFICATIONS

Test	Description
Thermal Shock	100 cycles of air-air thermal shock from -40°C to +125°C with 15 minute soaks (IEC 68-2-4)
High Temperature Storage	+105°C environment for 1,000 hours (IEC 68-2-2 Test Ba)
Low Temperature Storage	-40°C environment for 1,000 hours (IEC 68-2-1 Test Aa)
High Temperature Bias	+105°C environment while under bias for 1,000 hours (IEC 68-2-2 Test Ba)
Low Temperature Bias	-40°C environment while under bias for 1,000 hours (IEC 68-2-1 Test Aa)
Temperature/Humidity Bias	+85°C/85% R.H. environment while under bias for 1,000 hours (JESD22-A101A-B)
Vibration	12 minutes in each X, Y, Z axis from 20 to 2,000 Hz with peak acceleration of 20 G (MIL 883E, Method 2007.2,A)
ESD-HBM	3 discharges at ±2kV direct contact to I/O pins (ESD STM5.2)
ESD-LID/GND	3 discharges at ±8kV direct contact to lid when unit is grounded (IEC 61000-4-2)
ESD-MM	3 discharges at ±200V direct contact to IO pins (MIL 883E, Method 3015.7)
Reflow	5 reflow cycles with peak temperature of +260°C
Mechanical Shock	3 pulses of 10,000 G in each of the X, Y, and Z directions (IEC 68-2-27 Test Ea)

### NOTES:

Microphones meet all acoustic and electrical specifications before and after reliability testing, except sensitivity which can deviate up to 3dB.

After 3 reflow cycles, the sensitivity of the microphones shall not deviate more than 1 dB from its initial value.



