

Molded SMD Power Inductor



ASPIAIG-F6050 Series

Request Samples



Check Inventory



7.2 x 6.9 x 4.8 mm

RoHS/RoHS II Compliant

MSL Level = 1

Features

- PPAP ready and supported
- TS16949 certified production lines
- AEC-Q200 qualified
- Excellent current capacity – up to 20A
- Exceptionally low DCR – only 4.52mΩ
- Soft saturation
- Low profile for compact designs
- Shielded constructions for low EMI

Applications

- Automotive grade 0 and electric vehicles
- ADAS and body electronics
- Infotainment systems
- Lighting
- Motor control
- Solar inverters and solar power
- DC/DC converters in distributed power systems
- Battery powered device

Electrical Specifications

Part Number	Inductance	Tolerance	DC Resistance	Saturation Current	Temperature Rise Current	Electrode Width
	0.1MHz/0.1V		Max	Max	Max	±0.3
Units	μH	%	mΩ	A	A	mm
Symbol	L	M	DCR	Isat	Irms	D
ASPIAIG-F6050-1R0	1.00	20%	4.52	18.0	20.0	5.3
ASPIAIG-F6050-1R2	1.20	20%	5.83	16.0	18.0	5.3
ASPIAIG-F6050-1R5	1.50	20%	6.3	14.5	17.0	5.3
ASPIAIG-F6050-1R8	1.80	20%	7.1	13.5	16.0	5.3
ASPIAIG-F6050-2R2	2.20	20%	8.5	12.0	13.0	5.2
ASPIAIG-F6050-3R3	3.30	20%	12.5	10.0	11.0	5.2
ASPIAIG-F6050-4R3	4.30	20%	16.2	8.5	9.0	5.2
ASPIAIG-F6050-4R7	4.70	20%	18.4	8.0	8.5	5.2
ASPIAIG-F6050-5R6	5.60	20%	22.0	8.3	7.0	5.2
ASPIAIG-F6050-6R8	6.80	20%	23.1	7.0	6.6	5.2
ASPIAIG-F6050-8R2	8.20	20%	28.6	6.8	6.2	5.2

Test Conditions

Isat: Current at which the inductance drops 30% from its initial value

Irms: Current at which the temperature rises (ΔT , approximate 40 °C) from 20°C ambient

Operating Temperature: -55°C ~ +155°C (including self-temperature rise)

Storage Condition: -55°C ~ +155°C and R.H. 60% max (on PCB)

ASPIAIG-F6050 Series is RoHS Compliant and Pb free

ASPIAIG-F6050 Series is AEC-Q200 Grade 0 qualified (-55°C ~ +155°C ambient)

Operating Voltage: 40V

MSL level: 1



5101 Hidden Creek Ln Spicewood TX 78669
Phone: 512-371-6159 | Fax: 512-351-8858
For terms and conditions of sales, please visit:
www.abracon.com

REVISION A : 11/12/2021

ABRACON IS
ISO9001-2015
CERTIFIED

Molded SMD Power Inductor



ASPIAIG-F6050 Series

Request Samples



Check Inventory



7.2 x 6.9 x 4.8 mm
 RoHS/RoHS II Compliant
 MSL Level = 1

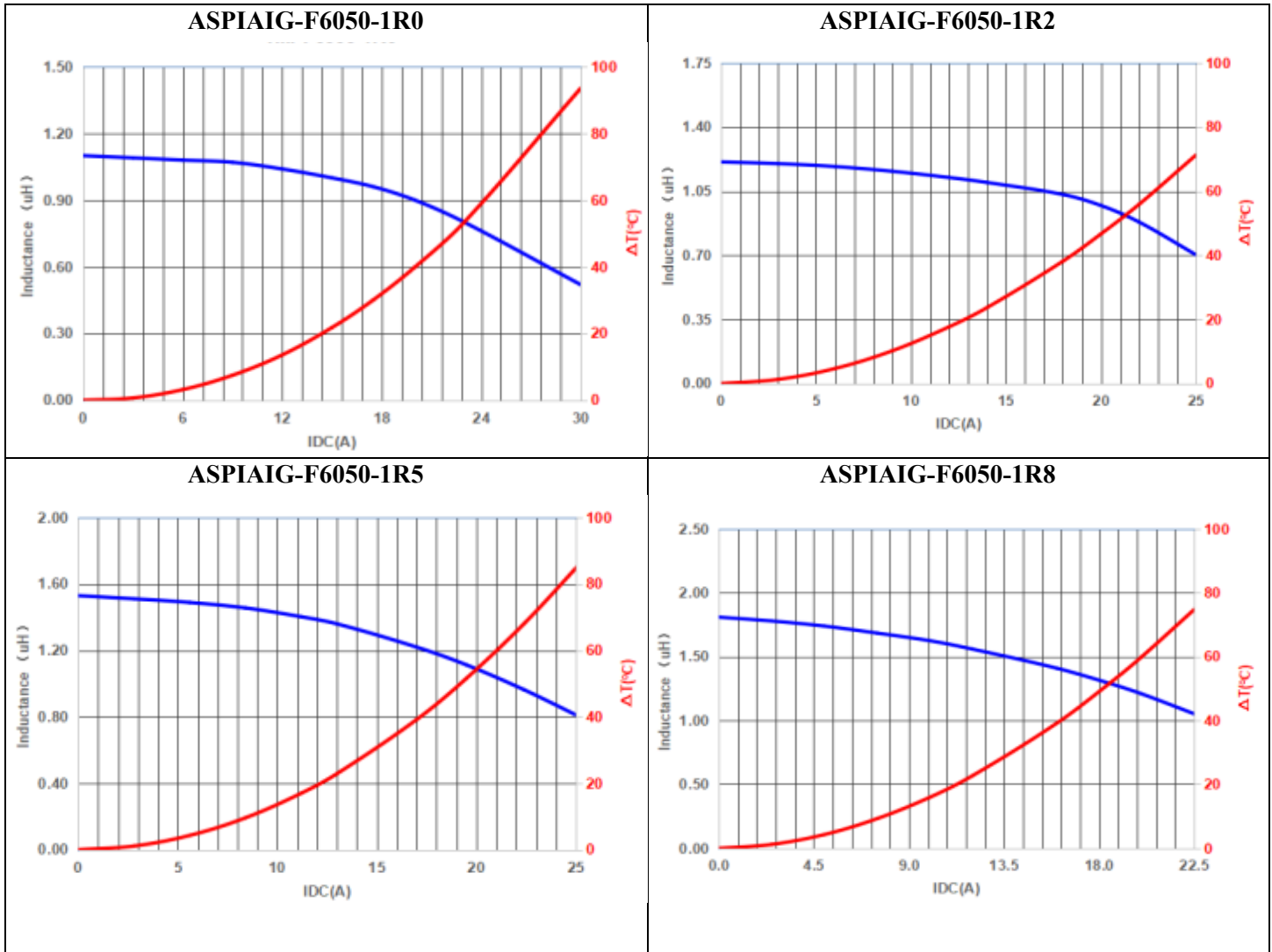

5101 Hidden Creek Ln Spicewood TX 78669
 Phone: 512-371-6159 | Fax: 512-351-8858
 For terms and conditions of sales, please visit:
www.abracon.com

REVISION A : 11/12/2021

ABRACON IS
 ISO9001-2015
 CERTIFIED

Molded SMD Power Inductor



ASPIAIG-F6050 Series

Request Samples



Check Inventory



7.2 x 6.9 x 4.8 mm
 RoHS/RoHS II Compliant
 MSL Level = 1

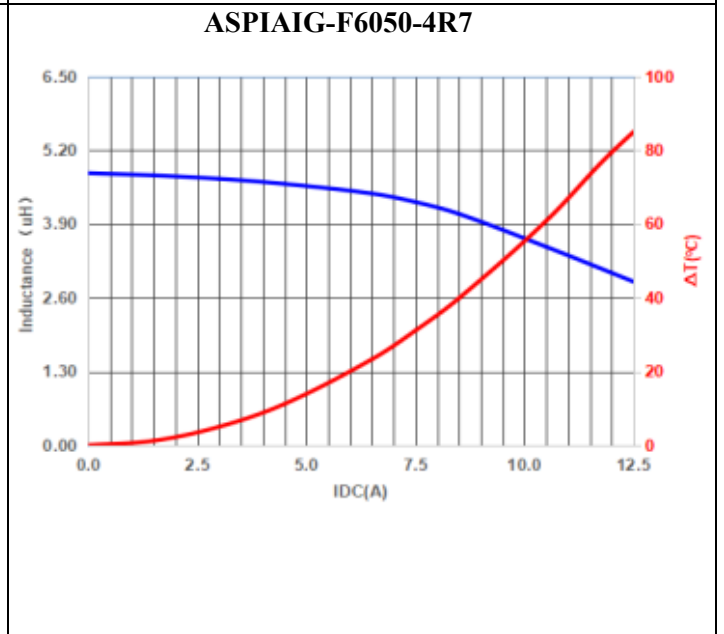
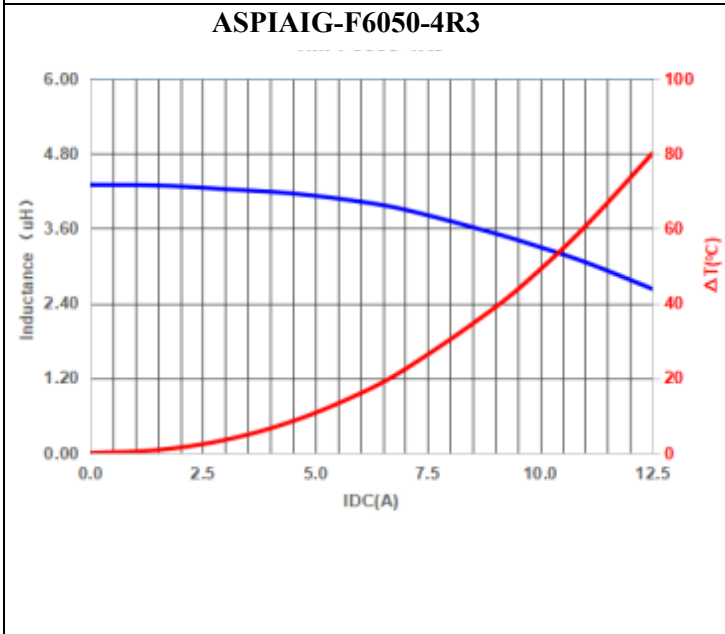
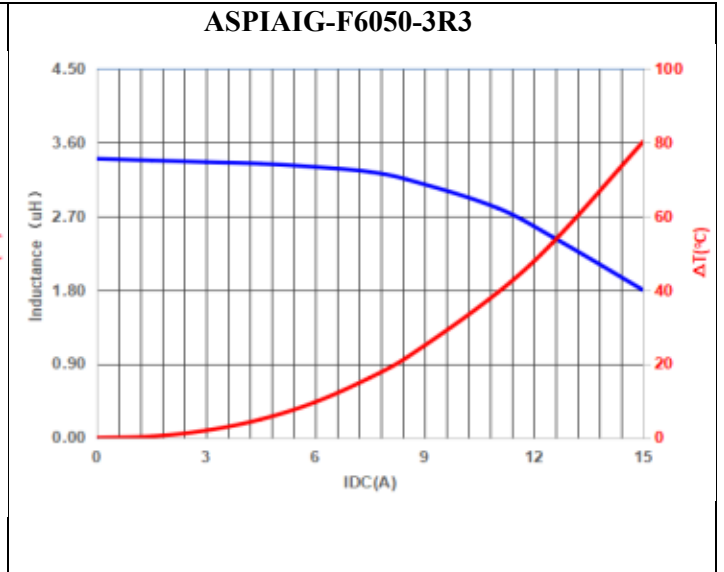
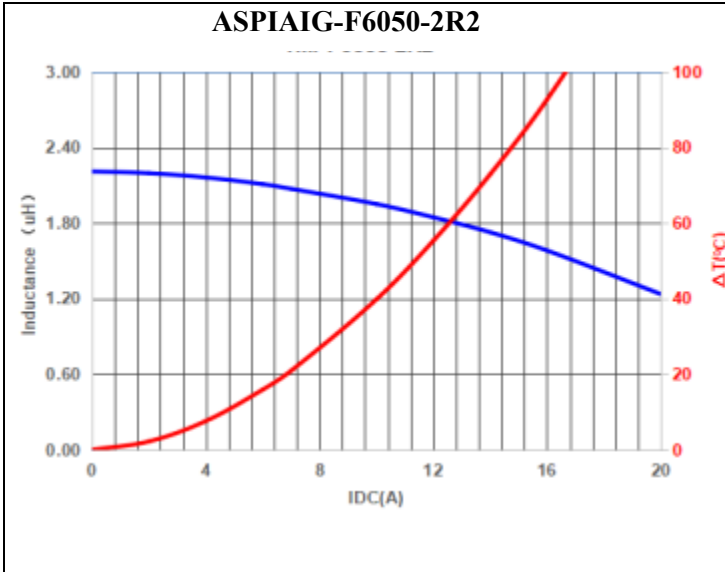

5101 Hidden Creek Ln Spicewood TX 78669
 Phone: 512-371-6159 | Fax: 512-351-8858
 For terms and conditions of sales, please visit:
www.abracon.com

REVISION A : 11/12/2021

ABRACON IS
 ISO9001-2015
 CERTIFIED

Molded SMD Power Inductor



ASPIAIG-F6050 Series

Request Samples



Check Inventory



7.2 x 6.9 x 4.8 mm
RoHS/RoHS II Compliant
MSL Level = 1

ASPIAIG-F6050-5R6

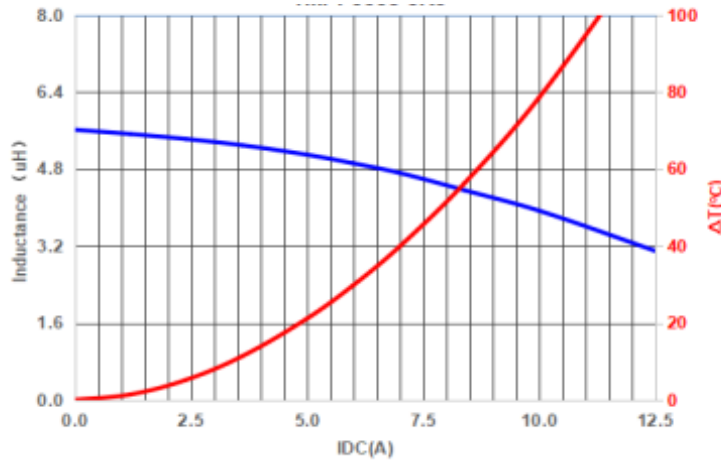

ASPIAIG-F6050-6R8

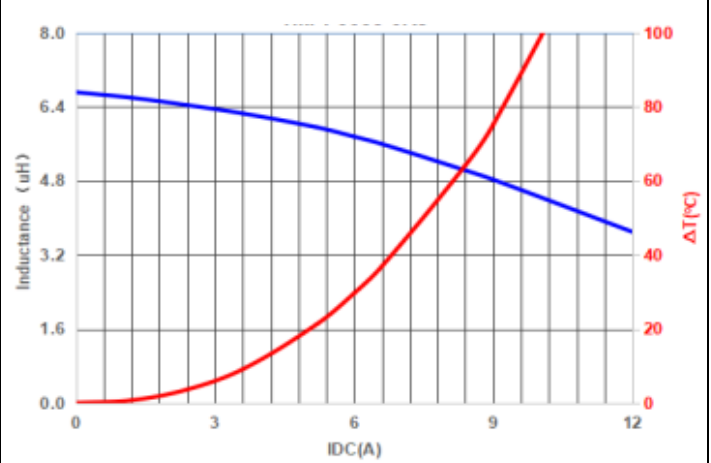

ASPIAIG-F6050-8R2

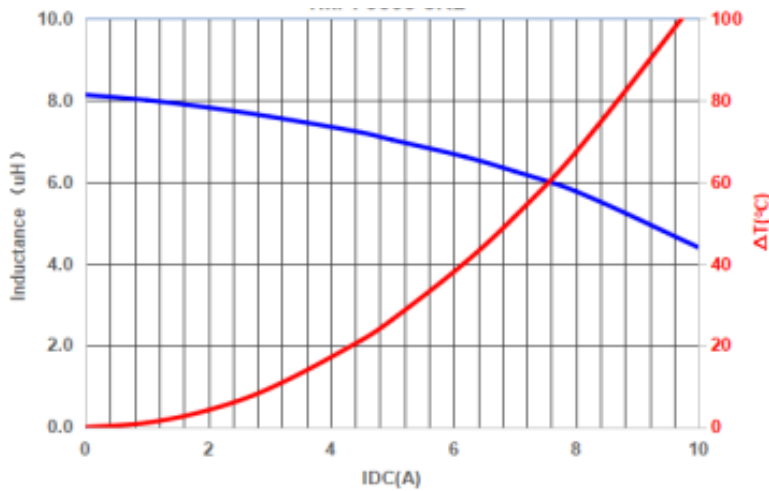

5101 Hidden Creek Ln Spicewood TX 78669
Phone: 512-371-6159 | Fax: 512-351-8858
For terms and conditions of sales, please visit:
www.abracon.com

REVISION A : 11/12/2021

ABRACON IS
ISO9001-2015
CERTIFIED

Molded SMD Power Inductor



ASPIAIG-F6050 Series

Request Samples

Check Inventory

7.2 x 6.9 x 4.8 mm
 RoHS/RoHS II Compliant
 MSL Level = 1

Mechanical Specifications

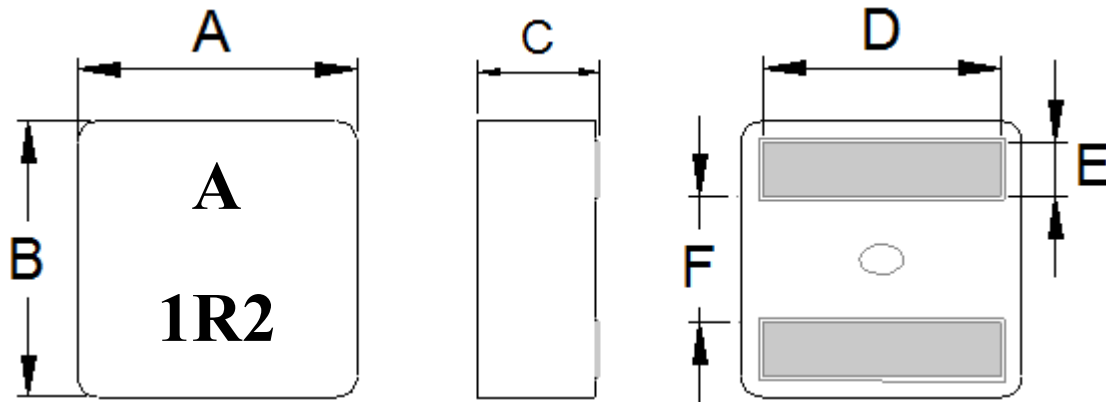

Series	A	B	C	D	E	F
ASPIAIG-F6050	7.2 ± 0.2	6.9 ± 0.2	4.8 ± 0.2	See Electrical spec. table	1.4 ± 0.2	2.6 ± 0.25

Recommended Land Pattern

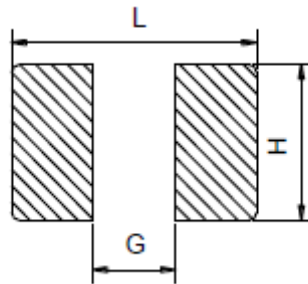

L Typ.	G Typ.	H Typ.
5.6	2.5	5.6

Dimension: mm

Molded SMD Power Inductor



ASPIAIG-F6050 Series

Request Samples



Check Inventory



7.2 x 6.9 x 4.8 mm
RoHS/RoHS II Compliant
 MSL Level = 1

Part Identification

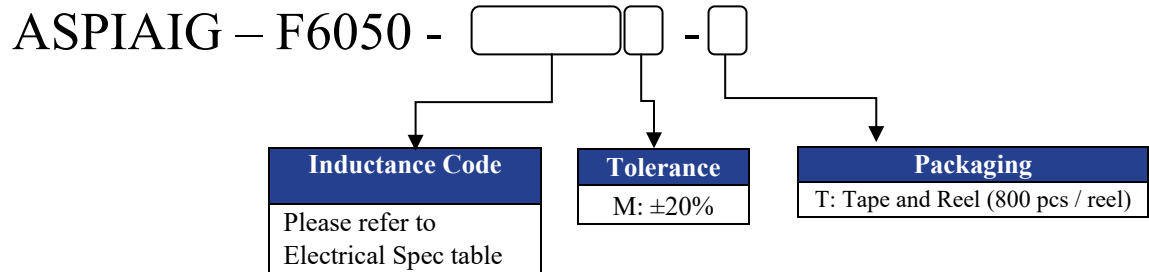

Marking

Marking Method: Ink

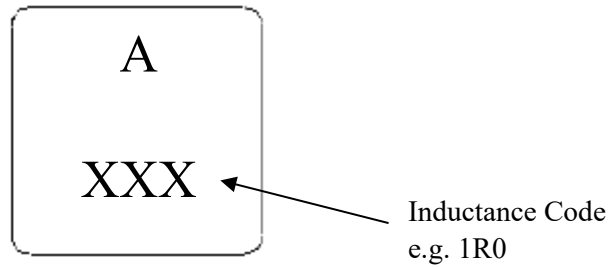

Materials

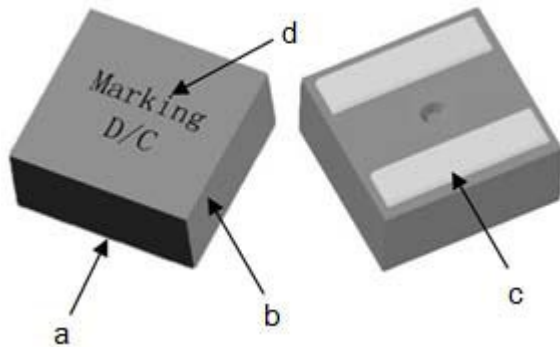

	Components	Material
a	Core	Alloy powder
b	Wire	220 deg. C Flat Wire
c	Solder	100% Pb free solder
d	Ink	Halogen-free ketone

Molded SMD Power Inductor



ASPIAIG-F6050 Series

Request Samples

Check Inventory

7.2 x 6.9 x 4.8 mm
 RoHS/RoHS II Compliant
 MSL Level = 1

Reflow Profile

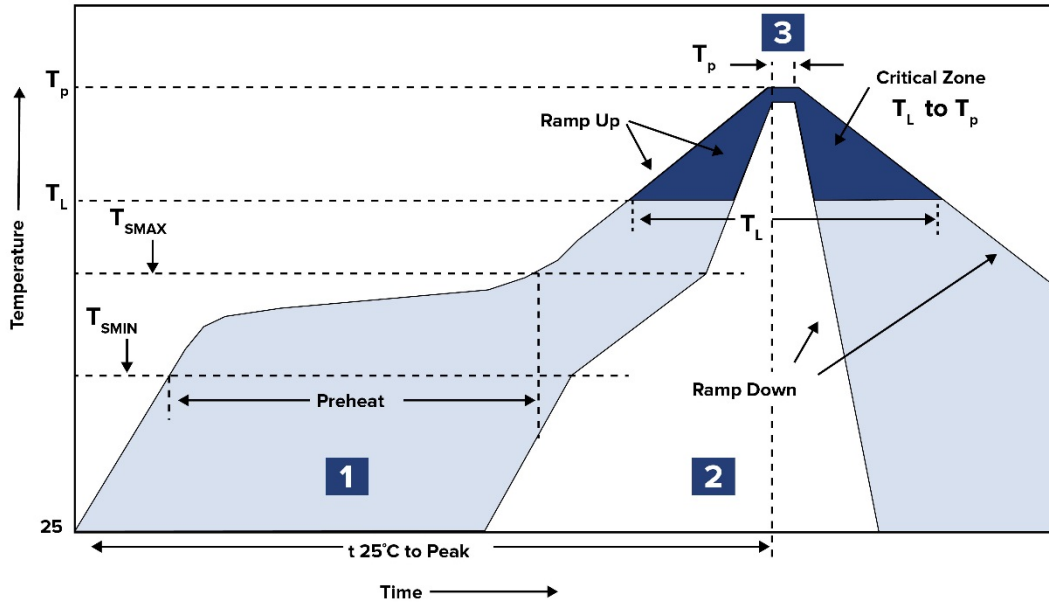

Zone	Description	Temperature	Times
1	Preheat	$T_{SMIN} \sim T_{SMAX}$ 150°C ~ 200°C	60 ~ 180 sec.
2	Reflow	T_L 217°C	60 ~ 150 sec.
3	Peak heat	T_P 260°C	10 sec. MAX

Molded SMD Power Inductor



ASPIAIG-F6050 Series

Request Samples



Check Inventory



7.2 x 6.9 x 4.8 mm
RoHS/RoHS II Compliant
MSL Level = 1

Packaging (Tape & Reel)

ASPIAIG-F6050: 800pcs / reel

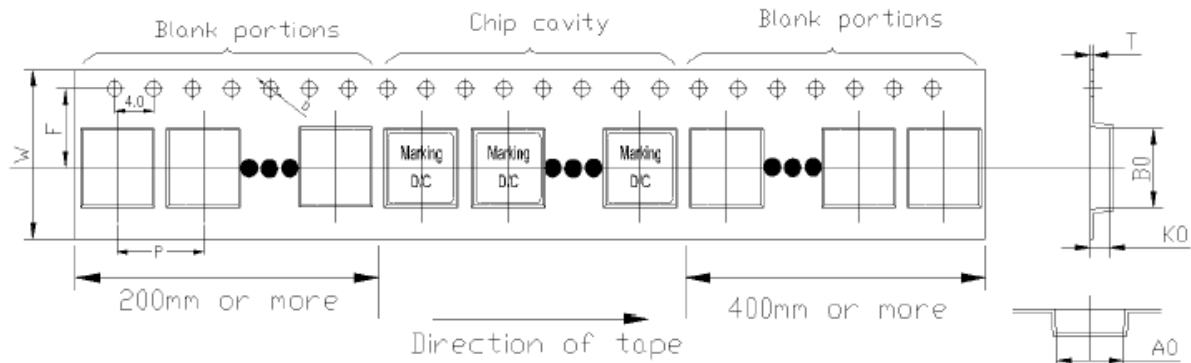

Series	W	F	P	D	A ₀	B ₀	T	K ₀
ASPIAIG-F6050	16.0±0.3	7.5±0.1	12.0±0.1	1.5±0.1	7.6±0.1	7.3 ±0.1	0.35±0.1	5.3±0.1

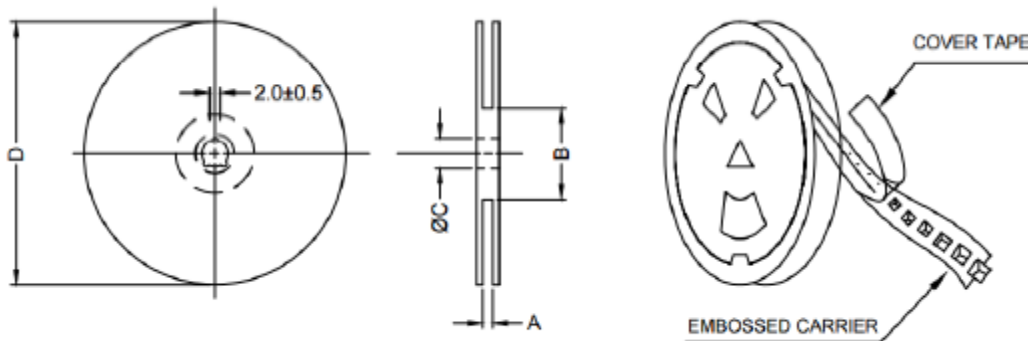

A	B	C	D
16.4+2/-0	100 ± 2	13.0+0.5/-0.2	330

Dimension: mm

ATTENTION: Abracon LLC's products are COTS – Commercial-Off-The-Shelf products; suitable for Commercial, Industrial and, where designated, Automotive Applications. Abracon's products are not specifically designed for Military, Aviation, Aerospace, Life-dependent Medical applications or any application requiring high reliability where component failure could result in loss of life and/or property. For applications requiring high reliability and/or presenting an extreme operating environment, written consent and authorization from Abracon LLC is required. Please contact Abracon LLC for more information.



5101 Hidden Creek Ln Spicewood TX 78669
 Phone: 512-371-6159 | Fax: 512-351-8858
 For terms and conditions of sales, please visit:
www.abracon.com

REVISION A : 11/12/2021

ABRACON IS
 ISO9001-2015
 CERTIFIED