

# X6S Dielectric

## General Specifications

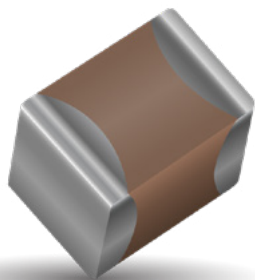

### FEATURES

- Offered in a complete range of products for both general and specialized applications and designed to meet a wide variety of needs.
- We have a worldwide network in order to supply our global customer bases quickly and efficiently.
- All of our products are highly reliable due to their monolithic structure of high-purity and superfine uniform ceramics and their integral internal electrodes.
- By combining superior manufacturing technology and materials with high dielectric constants, we produce extremely compact components with exceptional specifications.
- Our stringent quality control if every phase of production from material procurement to shipping ensures consistent manufacturing and superior quality.

### DIELECTRIC CHARACTERISTICS

- Temperature Range: -55 to + 105°C
- Standard Temperature: 25°C
- ΔC Max: ±22%



### HOW TO ORDER

<b>0201</b>	<b>4</b>	<b>W</b>	<b>105</b>	<b>M</b>	<b>A</b>	<b>T</b>	<b>2</b>	<b>A</b>
Size (L"xW")	Voltage 4.0V = 4 6.3V = 6 10V = Z 16V = Y 25V = 3	Dielectric X6S=W	Capacitance Code (In pF) 2 Sig. Digits + Number of Zeros	Capacitance Tolerance K = ±10% M = ±20%	Failure Rate A=Not Applicable	Termination* T = Plated Ni and Sn	Packaging 2 = 7" Reel	Special Code A = Std. Product

### HOW TO ORDER

Size	0201		0402	0603			
Packing	All Paper		All Paper	All Paper			
(L) Length	mm (in.)	0.60±0.09 (0.024±0.004)	1.00±0.20 (0.040±0.008)	1.60±0.20 (0.063±0.008)	1.60±0.10 (0.063±0.004)		
(W) Width	mm (in.)	0.30±0.09 (0.011±0.004)	0.50±0.20 (0.020±0.008)	0.80±0.20 (0.030±0.008)	0.80±0.10 (0.030±0.004)		
(t) Terminal	mm (in.)	0.18±0.05 (0.007±0.002)	0.25±0.10 (0.010±0.004)	0.40±0.20 (0.016±0.008)		0.40±0.20 (0.016±0.008)	
WVDC	<b>4</b>	<b>6.3</b>	<b>4</b>	<b>4</b>	<b>10</b>	<b>16</b>	<b>25</b>
Cap	1.0	A10	A10				C
(μF)	4.7					D	
	10				D9		
	22		B				
	47			D			
WVDC	<b>4</b>	<b>6.3</b>	<b>4</b>	<b>4</b>	<b>10</b>	<b>16</b>	<b>25</b>

Tan δ Code	Tan δ
7	10.0 % Max.
8	12.5 % Max.
9	15.0 % Max.
10	20.0 % Max.

Please Contact for other Tan δ values

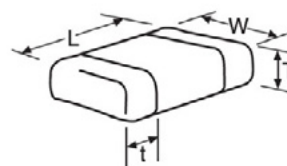

Cap Chart: Alphabets denotes Thickness and Tan δ. Please refer to the below table for details.

Letter	A	B	C	D
Max Thickness	0.39 (0.015)	0.80 (0.031)	0.90 (0.035)	1.0 (0.039)
Paper				

# X6S Dielectric

## General Specifications

### ELECTRICAL CHARACTERISTICS

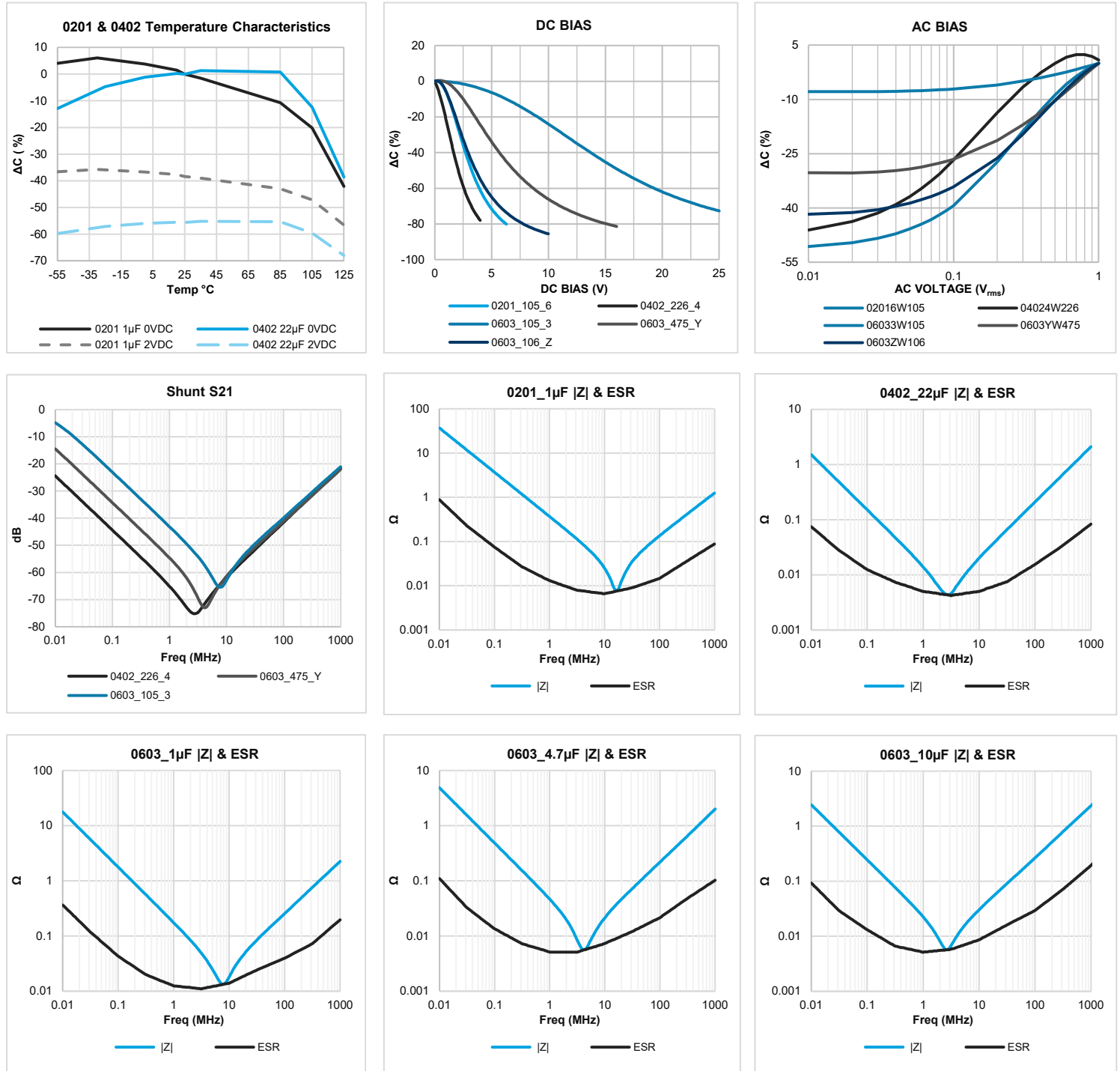

Please Contact for additional characteristics

# X6S Dielectric Specifications and Test Methods



Test Items		Test Conditions	Specification										
Capacitance Value (C)		Measure after heat treatment	Within Tolerance										
Tan δ		<table border="1"> <thead> <tr> <th>Capacitance</th> <th>Frequency</th> <th>Volt</th> </tr> </thead> <tbody> <tr> <td rowspan="2">C≤10 μF</td> <td rowspan="2">1 kHz ±10%</td> <td>1.0 ±0.2 V<sub>rms</sub></td> </tr> <tr> <td>0.5 ±0.2 V<sub>rms</sub></td> </tr> <tr> <td>C&gt;10 μF</td> <td>120 Hz ±10%</td> <td>0.5 ±0.2 V<sub>rms</sub></td> </tr> </tbody> </table> <p>The charge and discharge current of the capacitor must not exceed 50mA</p>	Capacitance	Frequency	Volt	C≤10 μF	1 kHz ±10%	1.0 ±0.2 V <sub>rms</sub>	0.5 ±0.2 V <sub>rms</sub>	C>10 μF	120 Hz ±10%	0.5 ±0.2 V <sub>rms</sub>	Refer to capacitance chart
	Capacitance	Frequency	Volt										
	C≤10 μF	1 kHz ±10%	1.0 ±0.2 V <sub>rms</sub>										
0.5 ±0.2 V <sub>rms</sub>													
C>10 μF	120 Hz ±10%	0.5 ±0.2 V <sub>rms</sub>											
Insulation Resistance (IR)		Apply the rated voltage for 1 minute and measure it in normal temperature and humidity. The charge and discharge current of the capacitor must not exceed 50mA.	Over 50MQ·μf										
Dielectric Resistance		Apply 2.5 times the rated voltage for 1-5 seconds. The charge and discharge current of the capacitor must not exceed 50mA.	No Defects										
Appearance		Microscope	No problem observed										
Termination Strength		Apply a sideward force of 500g (5N) to PCB-mounted sample.	No Defects										
Bending Strength		Glass epoxy PCB: Fulcrum spacing: 90mm, duration time 10 seconds.	No Significant damage with 1mm bending.										
Vibration Test	Appearance	Take the initial value after heat treatment. Vibration Frequency: 10-55 (Hz) Amplitude: 1.5mm Sweeping Condition: 10 → 55 → 10 Hz/ 1 minute in X, Y and Z Directions: 2 hours each, 6 hours total, and place in normal temperature and humidity. Measure the sample after heat treatment.	No problem observed										
	Δ C		Within Tolerance										
	Tan δ		Within Tolerance										
Soldering Heat Resistant	Appearance	Take the initial value after heat treatment. Soak the Sample in 260°C ±5°C solder for 10±0.5 seconds and place in normal temperature and humidity. Measure after heat treatment. (Pre-heating conditions)	No Defects										
	Δ C		Within ±7.5%										
	Tan δ		Within Tolerance										
	IR		Over 50MQ·μF										
	Withstanding Voltage		Resist without problem										
Solderability		Soak Condition:	Solder Coverage : 90% min.										
		<table border="1"> <tbody> <tr> <td>Sn-3AG-0.5Cu</td> <td>245 ± 5°C</td> <td>3 ±0.5 sec.</td> </tr> <tr> <td>Sn63 Solder</td> <td>235 ± 5°C</td> <td>2 ±0.5 sec.</td> </tr> </tbody> </table>		Sn-3AG-0.5Cu	245 ± 5°C	3 ±0.5 sec.	Sn63 Solder	235 ± 5°C	2 ±0.5 sec.				
Sn-3AG-0.5Cu	245 ± 5°C	3 ±0.5 sec.											
Sn63 Solder	235 ± 5°C	2 ±0.5 sec.											
Temperature Cycle	Appearance	Take initial value after heat treatment. (Cycle) Room Temperature (3min.) → Lowest Operating Temperature (30 min.) → Room Temperature (3 min.) → Highest Operating Temperature (30 min.) After 5 cycles, measure after heat treatment. The charge and discharge current of the capacitor must not exceed 50mA for IR and Withstanding Voltage measurement.	No Defects										
	Δ C		Within ±7.5%										
	Tan δ		Within Tolerance										
	IR		Over 50MQ·μF										
	Withstanding Voltage		Resist without problem										
Moisture Resistant Load	Appearance	Take the initial value after heat treatment. After applying the rated voltage for 500-512 hours in the condition of 40°C±2°C and 90 to 95% RH, place in normal temperature and humidity, then measure the sample after heat treatment. The charge and discharge current of the capacitor must not exceed 50mA for IR measurement	No Defects										
	Δ C		Within ±12.5%										
	Tan δ		200% max. of initial value										
	IR		Over 10MQ·μF										
High-Temperature Load	Appearance	Take the initial value after heat treatment. After applying *twice the rated voltage in the highest operating temperature for 1000-1012 hours, measure the sample after heat treatment in normal temperature and humidity. The charge and discharge current of the capacitor must not exceed 50mA for IR measurement.	No Defects										
	Δ C		Within ±12.5%										
	Tan δ		200% max. of initial value										
	IR		Over 10MQ·μF										
Heat Treatment		Expose sample to temperature of 140-150°C for 1 hour and leave the sample in normal temperature and humidity for 24 ±2 hours.											

\*Apply 1 times when the rated voltage is 4V or less

Please contact KYOCERA AVX for the optional specification of the capacitance chart.

# X6S Dielectric

## Test Conditions and Standards

Substrate for Adhesion Strength Test, Vibration Test, Soldering Heat Resistance Test, Temperature Cycle Test, Load Humidity Test, High-Temperature with Loading Test.

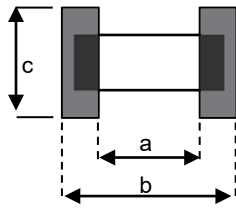

units: mm

Size (EIA Code)	a	b	c
0201	0.26	0.92	0.32
0402	0.4	1.4	0.5
0603	1.0	3.0	1.2

### SUBSTRATE FOR BENDING TEST Unit: mm

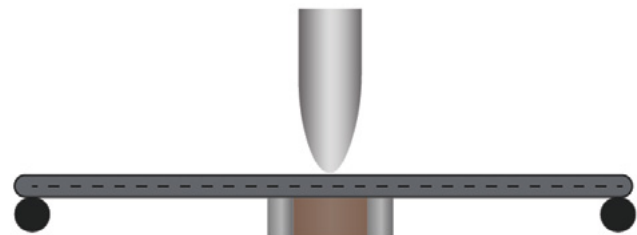
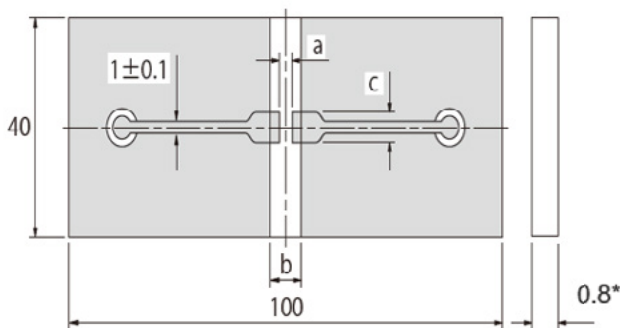

Testing Board: Glass Epoxy Board (CE4 or FR4)  
 Testing Board Thickness:  $0.8 \pm 0.1 \text{ mm}^*$   
 Circuit Thickness:  $0.04 \pm 0.01 \text{ mm}$

### STRUCTURE

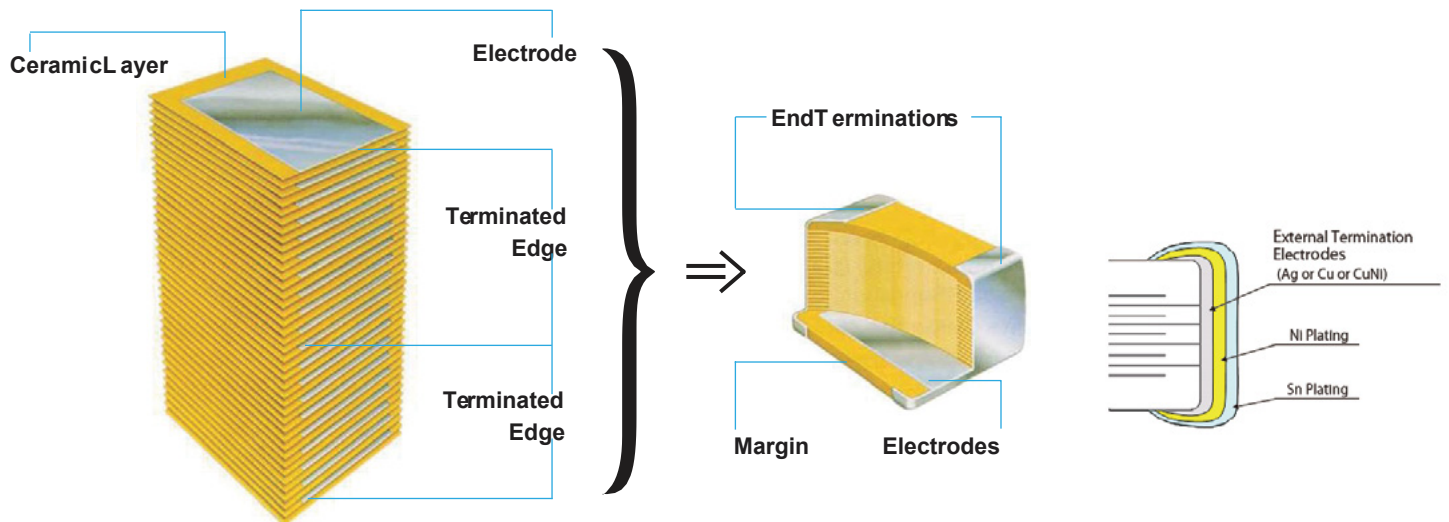

- Please contact your local AVX Sales office or distributor for specifications not covered in this catalog.
  - Capacitance range is subject to change without notice
- Please contact sales representative to confirm compatibility with your application.

# X6S Dielectric Packaging Options

## TAPE & REEL QUANTITIES

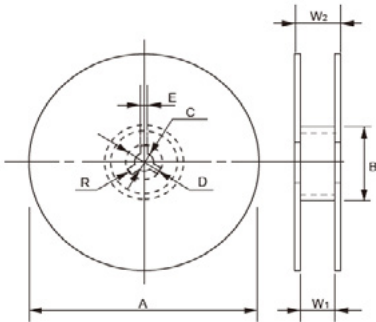

Code Reel	A	B	C	D	E	W <sub>1</sub>	W <sub>2</sub>	R
7-inch Reel	180	$\Phi 60$ min.	13±0.5	21±0.8	2.0±0.5	10.5±1.5	16.5 max.	1.0

## CARRIER TAPE

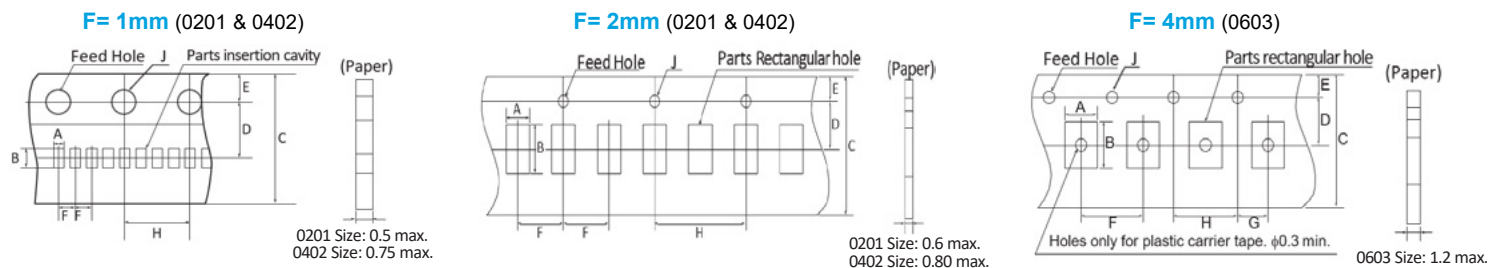

Units: mm

Size	A	B	C	D	E	F	G	H	J	Carrier Width
0201	0.37 ± 0.03	0.67 ± 0.03	8.0 +0.3/ -0.1	3.5 ± 0.05	1.75 ± 0.1	1.0 ± 0.05	-	4.0 ± 0.05	1.5 + 0.1	8mm
	0.39 ± 0.03	0.69 ± 0.03	8.0 ± 0.3			2.0 ± 0.05		4.0 ± 0.1		
	0.42 ± 0.03	0.72 ± 0.03	8.0 ± 0.3			2.0 ± 0.05		4.0 ± 0.1		
0402	0.65 ± 0.1	1.15 ± 0.1	8.0 +0.3/ -0.1	3.5 ± 0.05	1.75 ± 0.1	1.0 ± 0.05	-	4.0 ± 0.05	1.5 + 0.1	8mm
	0.75 ± 0.1		8.0 ± 0.3			2.0 ± 0.05		4.0 ± 0.1		
	0.8 ± 0.1		1.3 ± 0.1			2.0 ± 0.05		4.0 ± 0.1		
0603	1.0 ± 0.2	1.8 ± 0.2	8.0 ± 0.3	3.5 ± 0.05	1.75 ± 0.1	4.0 ± 0.1	2.0 ± 0.05	4.0 ± 0.1	1.5 + 0.1	8mm
	1.1 ± 0.2	1.9 ± 0.2								

## DETAIL OF LEADER AND TRAIL

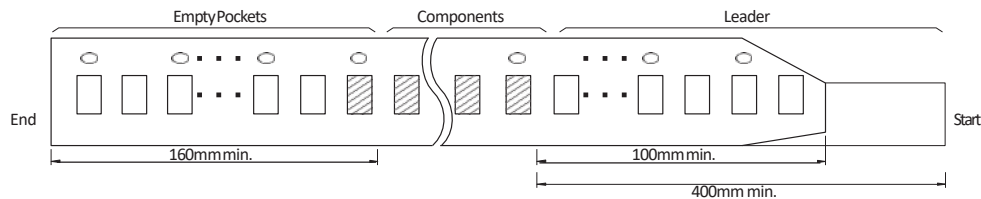

## ADHESIVE TAPE

- The exfoliative strength when peeling off the top tape from the carrier tape by the method of the following figure shall be \*0.1 to 0.5N.
- When the top tape is peeled off, the adhesive stays on the top tape.
- Chip capacitors will be in a state free without being stuck on the thermal adhesive tape.

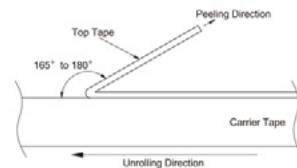

## CARRIER TAPE

- Chip will not fall off from carrier tape or carrier tape will not be damaged by bending than within a radius of 25mm.
- The chip are inserted continuously without any empty pocket.
- Chip will not be mis-mounted because of too big clearance between components and cavity. Also the waste of carrier tape will not fill a nozzle hole of mounting machine.

# X6S Dielectric

## Surface Mounting Information

### DIMENSIONS FOR RECOMMENDED TYPICAL LAND

Since the amount of solder (size of fillet) to be used has direct influence on the capacitor after mounting, the sufficient consideration is necessary. When the amounts of solder is too much, the stress that a capacitor receives becomes larger. It may become the cause of a crack in the capacitor. When the land design of printed wiring board is considered, it is necessary to set up the form and size of land pattern so that the amount of solder is suitable.

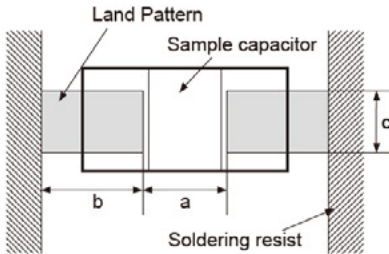

### GENERAL Unit: mm

Size (EIA Code)	Dimension		Recommended Land Dimensions		
	L	W	a	b	c
0201	$0.6 \pm 0.03$	$0.3 \pm 0.03$	0.20 to 0.25	0.25 to 0.35	0.30 to 0.40
	$0.6 \pm 0.5$	$0.3 \pm 0.05$			
	$0.6 \pm 0.09$	$0.3 \pm 0.09$	0.23 to 0.30		0.30 to 0.45
0402	$1.0 \pm 0.05$	$0.5 \pm 0.05$	0.30 to 0.50	0.35 to 0.45	0.40 to 0.60
	$1.0 \pm 0.15$	$0.5 \pm 0.15$			
	$1.0 \pm 0.20$	$0.5 \pm 0.20$	0.40 to 0.60	0.40 to 0.50	0.50 to 0.75
0603	$1.6 \pm 0.10$	$0.8 \pm 0.10$	0.70 to 1.00	0.80 to 1.00	0.60 to 0.90
	$1.6 \pm 0.15$	$0.8 \pm 0.15$			
	$1.6 \pm 0.20$	$0.8 \pm 0.20$	0.80 to 1.00	0.80 to 1.00	0.80 to 1.10
	$1.6 \pm 0.25$	$0.8 \pm 0.25$			

\* Recommended land dimensions may differ depending on dimensional tolerance

### MOUNTING DESIGN

The chip could crack if the PCB warps during processing after the chip has been soldered.

#### Recommended chip position on PCB to minimize stress from PCB warpage



### MOUNTING

1. If the position of the vacuum nozzle is too low, a large force may be applied to the chip capacitor during mounting, resulting in cracking.
2. During mounting, set the nozzle pressure to a static load of 1 to 3 N.
3. To minimize the shock of the vacuum nozzle, provide a support pin on the back of the PCB to minimize PCB flexure.



4. Bottom position of pick-up nozzle should be adjusted to the top surface of a substrate when camber is corrected

### RESIN MOLD

- If a large amount of resin is used for molding the chip, cracks may occur due to contraction stress during curing. To avoid such cracks, use a low shrinkage resin.
- The insulation resistance of the chip will degrade due to moisture absorption. Use a low moisture absorption resin.
- Check carefully that the resin does not generate a decomposition gas or reaction gas during the curing process or during normal storage. Such gases may crack the chip capacitor or damage the device itself.

# X6S Dielectric

## Surface Mounting Information

### DESIGN OF PRINTED CIRCUIT AND SOLDERING

The recommended fillet height shall be 1/2 of the thickness of capacitors or 0.5mm. When mounting two or more capacitors in the common land, it is necessary to separate the land with the solder resist strike so that it may become the exclusive land of each capacitor.

### IDEAL SOLDER HEIGHT

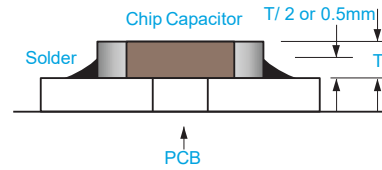

Item	Prohibited	Recommended Example : Separation by Solder Resist
Multiple Parts Mount		
Mount With Leaded Parts		
Wire Soldering After Mounting		
Side by Side Layout		

### SOLDERING METHOD

1. Ceramic is easily damaged by rapid heating or cooling. If some heat shock is unavoidable, preheat enough to limit the temperature difference (Delta T) to within 150°C
2. The product size 1.6x0.8mm to 3.2x1.6mm can be used in reflow and wave soldering, and the product size of bigger than 3.2x1.6mm, or smaller than 1.6 x 0.8mm can be used in reflow. Circuit shortage and smoking can be created by using capacitors which are used neglecting the above caution
3. Please see our recommended soldering conditions
4. In case of using Sn-Zn Solder, please contact us in advance
5. The following condition is recommended for spot heater application

### RECOMMENDED SPOT HEATER CONDITION

Item	Condition
Distance	5mm min.
Angle	45°
Projection Temp.	400°C
Flow Rate	Set at the minimum
Nozzle Diameter	2φ to 4φ (Single hole type)
Application Time	10 sec max.

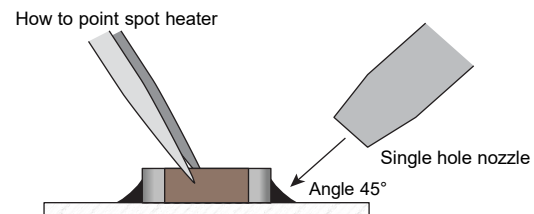

# X6S Dielectric

## Surface Mounting Information

### RECOMMENDED TEMPERATURE PROFILE (Sn-3Ag-0.5Cu)

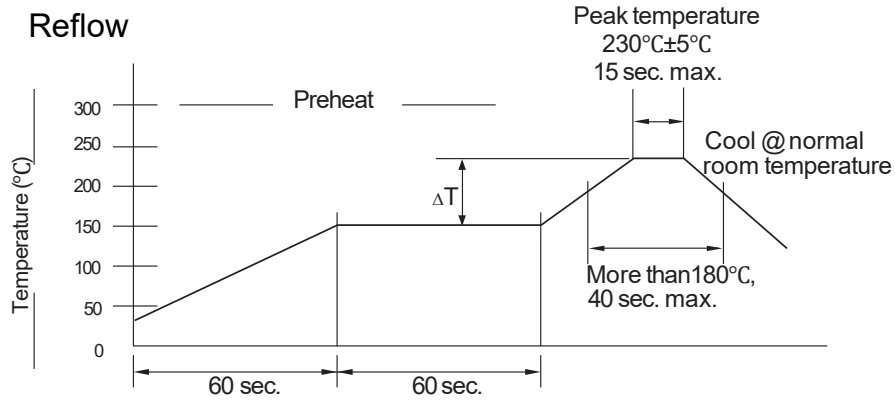

- ① Minimize soldering time.
- ② Ensure that the temperature difference ( $\Delta T$ ) does not exceed 150°C.
- ③ Ensure that the temperature difference ( $\Delta T$ ) does not exceed 130°C for 3.2×2.5mm size or larger.
- ④ MLCC can withstand the above reflow conditions up to 3 times.

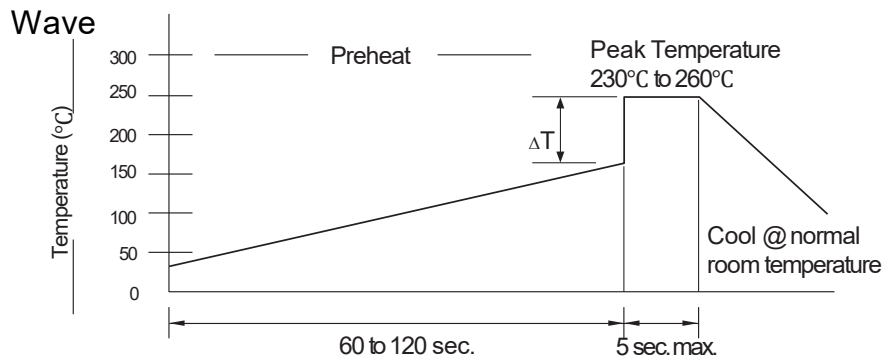

- ① Ensure that the chip capacitor is preheated adequately.
- ② Ensure that the temperature difference ( $\Delta T$ ) does not exceed 150°C.
- ③ Cool naturally after soldering.
- ④ Wave soldering is not applicable for chips with size of 3.2×2.5mm or larger of 1.0×0.5mm or smaller and capacitor arrays.



# X6S Dielectric

## Surface Mounting Information

### RECOMMENDED TEMPERATURE (63n Solder)

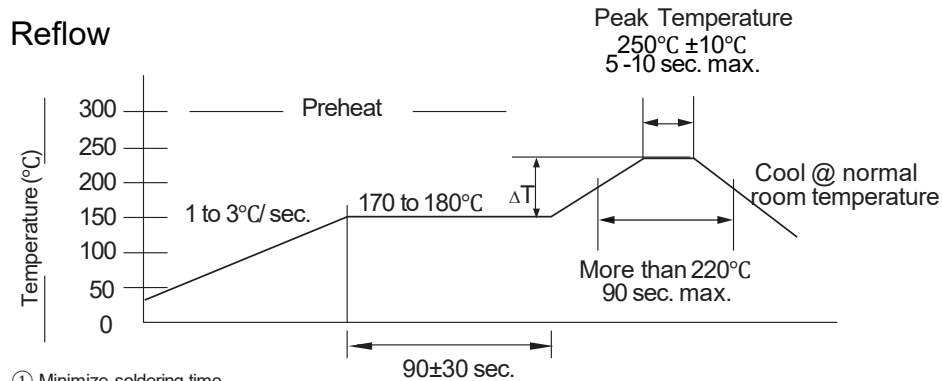

- ① Minimize soldering time.
- ② Ensure that allowable temperature difference does not exceed 150°C.
- ③ Ensure that allowable temperature difference does not exceed 130°C for 3.2×2.5mm size or larger.
- ④ MLCC can withstand the above reflow conditions up to 3 times.
- ⑤ N<sub>2</sub> atmosphere is recommended for reflow of products of 0.4mm×0.2mm size or smaller.

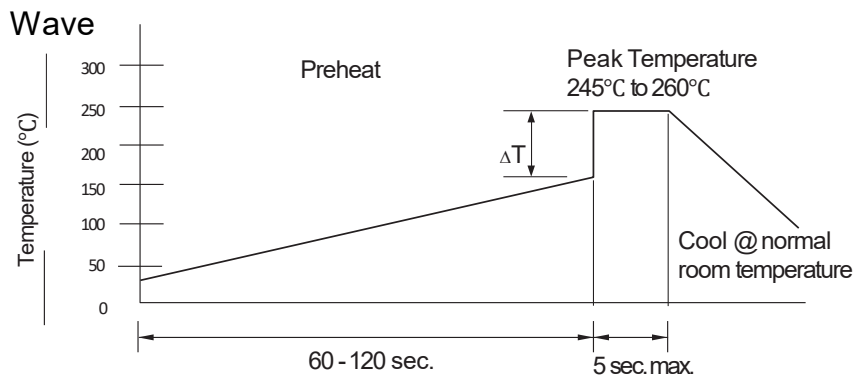

- ① Ensure that the chip capacitor is preheated adequately.
- ② Ensure that the temperature difference ( $\Delta T$ ) does not exceed 150°C.
- ③ Cool naturally after soldering.
- ④ Wave soldering is not applicable for chips with size of 3.2×2.5mm or larger of 1.0×0.5mm or smaller and capacitor arrays.

# X6S Dielectric

## Precautions

### CIRCUIT DESIGN

1. Once application and assembly environments have been checked, the capacitor may be used in conformance with the rating and performance which are provided in both the catalog and the specifications. Use exceeding that which is specified may result in inferior performance or cause a short, open, smoking, or flaming to occur, etc.
2. Please consult the manufacturer in advance when the capacitor is used in devices such as: devices which deal with human life, i.e. medical devices; devices which are highly public orientated; and devices which demand a high standard of liability. Accident or malfunction of devices such as medical devices, space equipment and devices having to do with atomic power could generate grave consequence with respect to human lives or, possibly, a portion of the public. Capacitors used in these devices may require high reliability design different from that of general-purpose capacitors.
3. Please use the capacitors in conformance with the operating temperature provided in both the catalog and the specifications. Be especially cautious not to exceed the maximum temperature. In the situation the maximum temperature set forth in both the catalog and specifications is exceeded, the capacitor's insulation resistance may deteriorate, power may suddenly surge and short-circuit may occur. The capacitor has a loss and may self-heat due to equivalent series resistance when alternating electric current is passed therethrough. As this effect becomes especially pronounced in high frequency circuits, please exercise caution. When using the capacitor in a (self-heating) circuit, please make sure the surface of the capacitor remains under the maximum temperature for usage. Also, please make certain temperature rises remain below 20°C .
4. Please keep voltage under the rated voltage which is applied to the capacitor. Also, please make certain the peak voltage remains below the rated voltage when AC voltage is super-imposed to the DC voltage. In the situation where AC or pulse voltage is employed, ensure average peak voltage does not exceed the rated voltage. Exceeding the rated voltage provided in both catalog and specifications may lead to defective withstanding voltage or, in worst case situations, may cause the capacitor to smoke or flame.
5. When the capacitor is to be employed in a circuit in which there is continuous application of a high frequency voltage or a steep pulse voltage, even though it is within the rated voltage, please inquire to the manufacturer. In the situation the capacitor is to be employed using a high frequency AC voltage or an extremely fast rising pulse voltage, even though it is within the rated voltage, it is possible capacitor reliability will deteriorate.
6. It is a common phenomenon of high-dielectric products to have a deteriorated amount of static electricity due to the application of DC voltage. Due caution is necessary as the degree of deterioration varies depending on the quality of capacitor materials, capacity, as well as the load voltage at the time of operation.
7. Do not use the capacitor in an environment where it might easily exceed the respective provisions concerning shock and vibration specified in the catalog and specifications. In addition, it is a common piezo phenomenon of high dielectric products to have some voltage due to vibration or to have noise due to voltage change. Please contact sales in such case.
8. If the electrostatic capacity value of the delivered capacitor is within the specified tolerance, please consider this when designing the respective product in order that the assembled product function appropriately.
9. Please contact us upon using conductive adhesives.

### STORAGE

1. If the component is stored in minimal packaging (a heat-sealed or zippered plastic bag), the bag should be kept closed. Once the bag has been opened, reseal it or store it in a desiccator.
2. Keep storage place temperature + 5 to + 40 °C , humidity 20 to 70% RH. See JIS C 6 0721-3-1, class 1K2 for other climatic conditions.
3. The storage atmosphere must be free of corrosive gas such as sulfur dioxide and chlorine. Also, avoid exposing the product to saline moisture. If the product is exposed to such atmospheres, the terminals will oxidize and solderability will be affected.
4. Precautions 1) to 3) apply to chip capacitors packaged in carrier tapes.
5. The solderability is assured for 6 months from our shipping date if the above storage precautions are followed.