

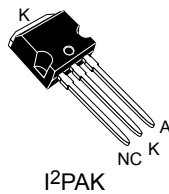

Automotive 650 V power Schottky silicon carbide diode

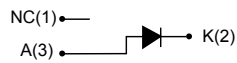

Features

- AEC-Q101 qualified 
- No reverse recovery charge in application current range
- Switching behavior independent of temperature
- Recommended to PFC applications
- PPAP capable
- ECOPACK®2 compliant component

Description

The SiC diode is an ultra-high performance power Schottky diode. It is manufactured using a silicon carbide substrate. The wide band gap material allows the design of a Schottky diode structure with a 650 V rating. Due to the Schottky construction, no recovery is shown at turn-off and ringing patterns are negligible. The minimal capacitive turn-off behavior is independent of temperature.

Especially suited for use in PFC applications, the STPSC10C065-Y will boost performance in hard switching conditions.

Product status link

[STPSC10C065-Y](#)

Product summary

$I_{F(AV)}$	10 A
V_{RRM}	650 V
T_j (max.)	175 °C

1 Characteristics

Table 1. Absolute ratings (limiting values at 25 °C, unless otherwise specified)

Symbol	Parameter		Value	Unit
V _{RRM}	Repetitive peak reverse voltage	T _j from -40 °C to 175 °C	650	V
I _{F(RMS)}	Forward rms current		22	A
I _{F(AV)}	Average forward current	T _c = 120 °C, DC current ⁽¹⁾	10	A
I _{FSM}	Surge non repetitive forward current	t _p = 10 ms sinusoidal, T _c = 25 °C	85	A
		t _p = 10 ms sinusoidal, T _c = 125 °C	75	
		t _p = 10 μs square, T _c = 25 °C	500	
T _{stg}	Storage temperature range		-55 to +175	°C
T _j	Operating junction temperature ⁽²⁾		-40 to +175	°C

1. Value based on R_{th(j-c)} max.

2. (dP_{tot}/dT_j) < (1/R_{th(j-a)}) condition to avoid thermal runaway for a diode on its own heatsink.

Table 2. Thermal resistance parameters

Symbol	Parameter	Value		Unit
		Typ.	Max.	
R _{th(j-c)}	Junction to case	1.3	2.0	°C/W

Table 3. Static electrical characteristics

Symbol	Parameter	Test conditions		Min.	Typ.	Max.	Unit
I _R ⁽¹⁾	Reverse leakage current	T _j = 25 °C	V _R = V _{RRM}	-	9	100	μA
		T _j = 150 °C		-	85	425	
V _F ⁽²⁾	Forward voltage drop	T _j = 25 °C	I _F = 10 A	-	1.56	1.75	V
		T _j = 150 °C		-	1.98	2.50	

1. Pulse test: t_p = 10 ms, δ < 2%

2. Pulse test: t_p = 500 μs, δ < 2%

To evaluate the conduction losses, use the following equation:

$$P = 1.35 \times I_{F(AV)} + 0.12 \times I_{F(RMS)}^2$$

Table 4. Dynamic electrical characteristics

Symbol	Parameter	Test conditions	Typ.	Unit
Q _{Cj} ⁽¹⁾	Total capacitive charge	V _R = 400 V	26.4	nC
C _j	Total capacitance	V _R = 0 V, T _c = 25 °C, F = 1 MHz	480	pF
		V _R = 300 V, T _c = 25 °C, F = 1 MHz	47	

1. Most accurate value for the capacitive charge: $Q_{Cj}(V_R) = \int_0^{V_R} C_j(V) dV$

1.1 Characteristics (curves)

Figure 1. Forward voltage drop versus forward current (typical values, low level)

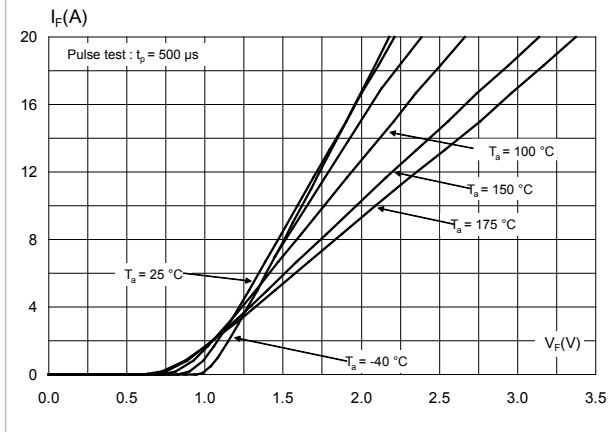

Figure 2. Forward voltage drop versus forward current (typical values, high level)

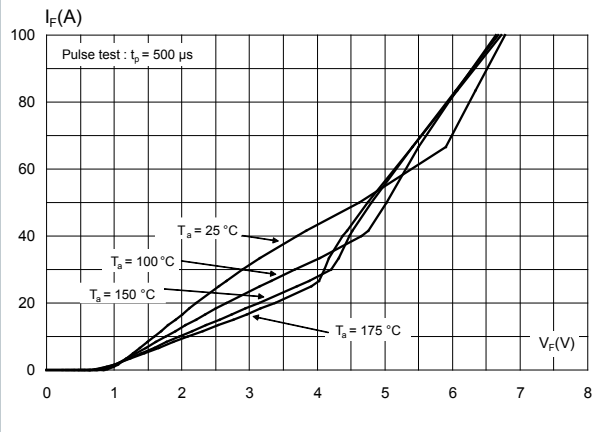

Figure 3. Reverse leakage current versus reverse voltage applied (typical values)

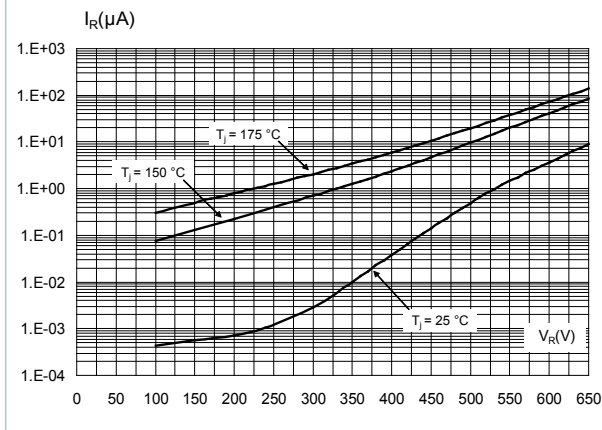

Figure 4. Peak forward current versus case temperature

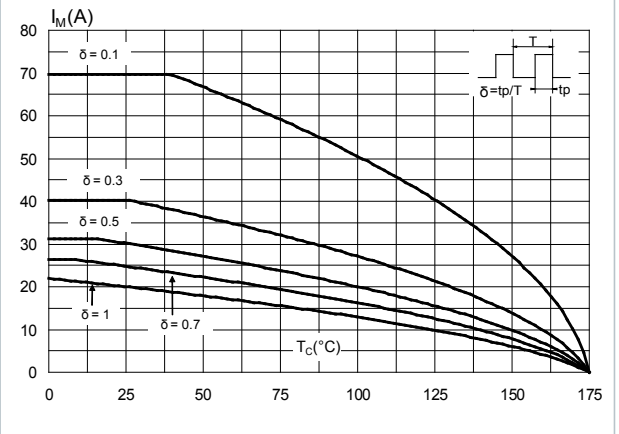

Figure 5. Junction capacitance versus reverse voltage applied (typical values)

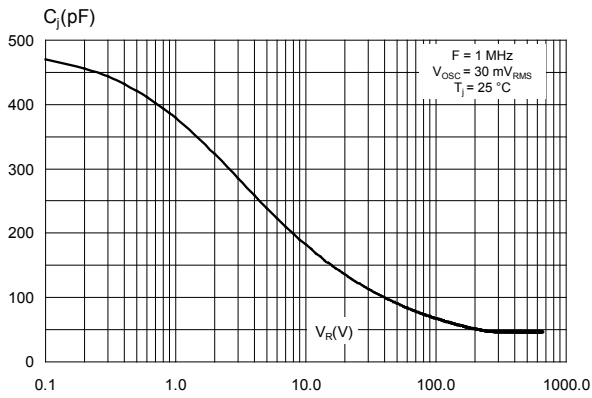

Figure 6. Relative variation of thermal impedance junction to case versus pulse duration

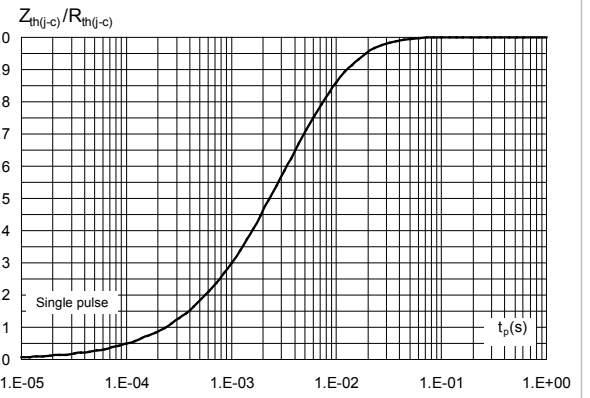

Figure 7. Non-repetitive peak surge forward current versus pulse duration (sinusoidal waveform)

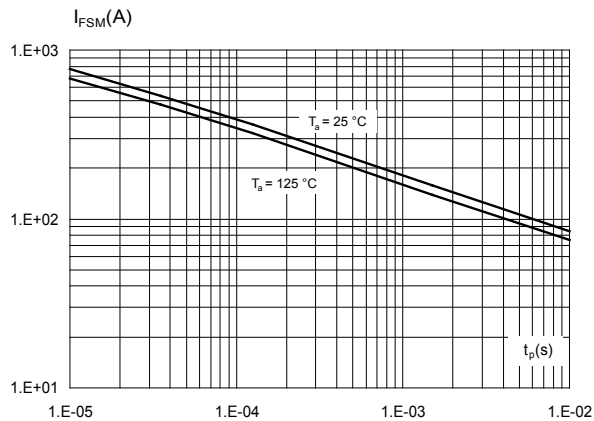
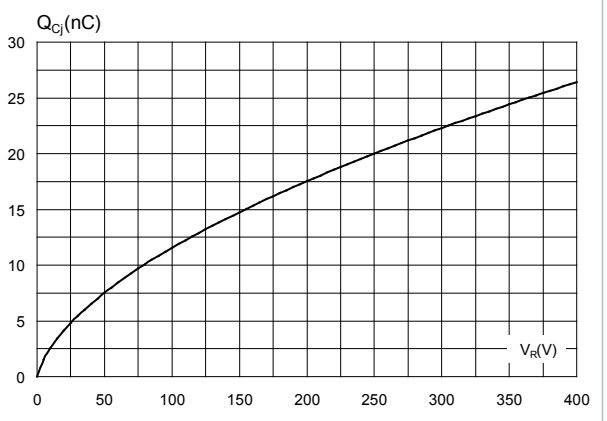

Figure 8. Total capacitive charges versus reverse voltage applied (typical values)



2 Package information

In order to meet environmental requirements, ST offers these devices in different grades of ECOPACK® packages, depending on their level of environmental compliance. ECOPACK® specifications, grade definitions and product status are available at: www.st.com. ECOPACK® is an ST trademark.

2.1 I²PAK package information

- Epoxy meets UL 94,V0
- Cooling method: by conduction (C)

Figure 9. I²PAK package outline

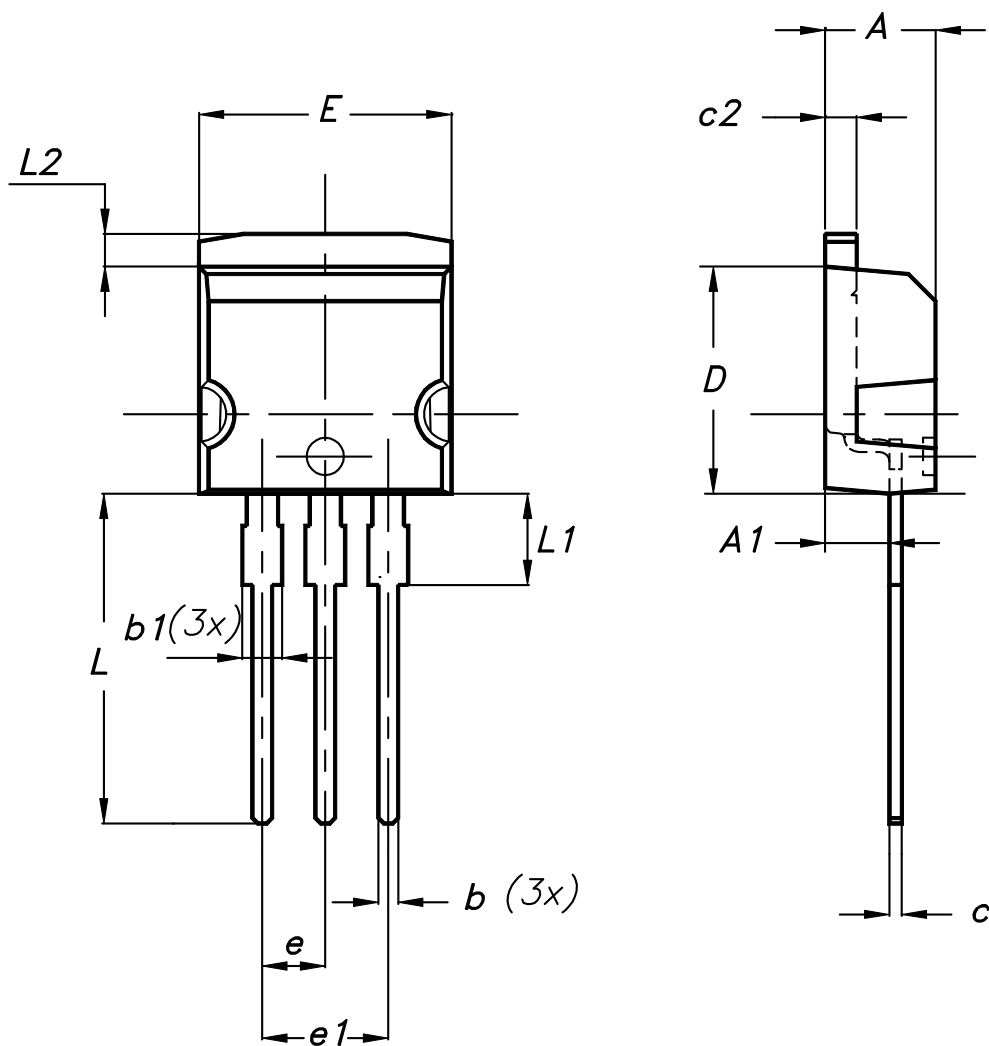

Table 5. I²PAK package mechanical data

Ref.	Dimensions			
	Millimeters		Inches (for reference only)	
	Min.	Max.	Min.	Max.
A	4.40	4.60	0.173	0.181
A1	2.40	2.72	0.094	0.107
b	0.61	0.88	0.024	0.035
b1	1.14	1.70	0.044	0.067
c	0.49	0.70	0.019	0.028
c2	1.23	1.32	0.048	0.052
D	8.95	9.35	0.352	0.368
e	2.40	2.70	0.094	0.106
e1	4.95	5.15	0.195	0.203
E	10.00	10.40	0.394	0.409
L	13.00	14.00	0.512	0.551
L1	3.50	3.93	0.138	0.155
L2	1.27	1.40	0.050	0.055

3 Ordering information

Table 6. Ordering information

Order code	Marking	Package	Weight	Base qty.	Delivery mode
STPSC10C065RY	PSC10C065RY	I ² PAK	1.5 g	50	Tube

Revision history

Table 7. Document revision history

Date	Revision	Changes
16-Feb-2018	1	First issue.
24-Sep-2018	2	Corrected cover image.

IMPORTANT NOTICE – PLEASE READ CAREFULLY

STMicroelectronics NV and its subsidiaries (“ST”) reserve the right to make changes, corrections, enhancements, modifications, and improvements to ST products and/or to this document at any time without notice. Purchasers should obtain the latest relevant information on ST products before placing orders. ST products are sold pursuant to ST’s terms and conditions of sale in place at the time of order acknowledgement.

Purchasers are solely responsible for the choice, selection, and use of ST products and ST assumes no liability for application assistance or the design of Purchasers’ products.

No license, express or implied, to any intellectual property right is granted by ST herein.

Resale of ST products with provisions different from the information set forth herein shall void any warranty granted by ST for such product.

ST and the ST logo are trademarks of ST. All other product or service names are the property of their respective owners.

Information in this document supersedes and replaces information previously supplied in any prior versions of this document.

© 2018 STMicroelectronics – All rights reserved