

CD54/74AC240/241/244 CD54/74ACT240/241/244

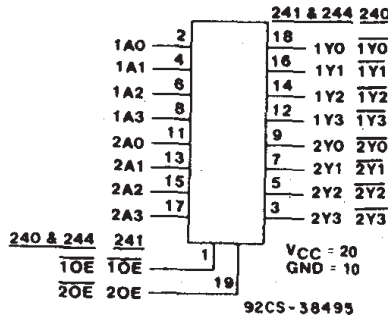

Data sheet acquired from Harris Semiconductor
SCHS287B - Revised January 2004



FUNCTIONAL DIAGRAM & TERMINAL ASSIGNMENT

The RCA CD54/74AC240, CD54/74AC241, and CD54/74AC244 and the CD54/74ACT240, CD54/74ACT241, and CD54/74ACT244 3-state octal buffer/line drivers use the RCA ADVANCED CMOS technology. The CD54/74AC/ACT240 and CD54/74AC/ACT244 have active-LOW output enables ($\overline{1OE}$, $\overline{2OE}$). The CD54/74AC/ACT241 has one active-LOW ($\overline{1OE}$) and one active-HIGH (2OE) output enable.

The CD74AC240 and CD74ACT240 are supplied in 20-lead dual-in-line plastic packages (E suffix) and 20-lead small-outline packages (M and M96 suffixes). The CD74AC241 is supplied in 20-lead dual-in-line plastic packages (E suffix) and the CD74ACT241 is supplied in 20-lead dual-in-line plastic packages (E suffix) and 20-lead small-outline packages (M96 suffix). The CD74AC244 and CD74ACT244 are supplied in 20-lead dual-in-line plastic packages (E suffix), 20-lead small-outline packages (M and M96 suffixes), and 20-lead shrink small-outline packages (SM96 suffix). These package types are operable over the following temperature ranges: Commercial (0 to 70°C); Industrial (-40 to +85°C); and Extended Industrial/Military (-55 to +125°C).

The CD54AC240 and CD54AC244 and the CD54ACT240, CD54ACT241, and CD54ACT244 are supplied in 20-lead hermetic dual-in-line ceramic packages (F3A suffix) and are operable over the -55 to +125°C temperature range.

Octal Buffer/Line Drivers, 3-State

- CD54/74AC/ACT240 - Inverting
- CD54/74AC/ACT241 - Non-Inverting
- CD54/74AC/ACT244 - Non-Inverting

Type Features:

- Buffered inputs
- Typical propagation delay:
3.6 ns @ $V_{CC} = 5V$, $T_A = 25^\circ C$, $C_L = 50 pF$

Family Features:

- Exceeds 2-kV ESD Protection - MIL-STD-883, Method 3015
- SCR-Latch-up-resistant CMOS process and circuit design
- Speed of bipolar FAST*/AS/S with significantly reduced power consumption
- Balanced propagation delays
- AC types feature 1.5-V to 5.5-V operation and balanced noise immunity at 30% of the supply
- ± 24 -mA output drive current
 - Fanout to 15 FAST* ICs
 - Drives 50-ohm transmission lines

*FAST is a Registered Trademark of Fairchild Semiconductor Corp.

TRUTH TABLES

| INPUTS | | OUTPUT | |
|-------------------------------------|---|--------|--|
| $\overline{1OE}$, $\overline{2OE}$ | A | Y | |
| L | L | H | |
| L | H | L | |
| H | X | Z | |

(AC/ACT240)

| INPUTS | | OUTPUT | |
|-------------------------------------|---|--------|--|
| $\overline{1OE}$, $\overline{2OE}$ | A | Y | |
| L | L | L | |
| L | H | H | |
| H | X | Z | |

(AC/ACT244)

| INPUTS | | OUTPUT | | INPUTS | | OUTPUT | |
|------------------|----|--------|-----|--------|----|--------|--|
| $\overline{1OE}$ | 1A | 1Y | 2OE | 2A | 2Y | | |
| L | L | L | L | X | Z | | |
| L | H | H | H | L | L | | |
| H | X | Z | H | H | H | | |

(AC/ACT241)

H = HIGH Voltage Level
L = LOW Voltage Level
X = Immaterial
Z = HIGH Impedance

This data sheet is applicable to the CD54/74AC240, CD54ACT240, and CD54/74ACT241. The CD54/74AC241 were not acquired from Harris Semiconductor. See SCHS244 for information on the CD74ACT240, CD74AC244, and CD74ACT244.

Copyright © 2004, Texas Instruments Incorporated

CD54/74AC240/241/244 CD54/74ACT240/241/244

MAXIMUM RATINGS, Absolute-Maximum Values:

| | |
|---|---|
| DC SUPPLY-VOLTAGE (V_{CC}) | -0.5 to 6 V |
| DC INPUT DIODE CURRENT, I_{IK} (for $V_I < -0.5$ V or $V_I > V_{CC} + 0.5$ V) | ± 20 mA |
| DC OUTPUT DIODE CURRENT, I_{OK} (for $V_O < -0.5$ V or $V_O > V_{CC} + 0.5$ V) | ± 50 mA |
| DC OUTPUT SOURCE OR SINK CURRENT per Output Pin, I_O (for $V_O > -0.5$ V or $V_O < V_{CC} + 0.5$ V) | ± 50 mA |
| DC V_{CC} or GROUND CURRENT (I_{CC} or I_{GND}) | ± 100 mA* |
| POWER DISSIPATION PER PACKAGE (P_D): | |
| For $T_A = -40$ to $+85^\circ\text{C}$ (Package Type E) | 500 mW |
| For $T_A = -40$ to $+70^\circ\text{C}$ (Package Type M) | 400 mW |
| For $T_A = +70$ to $+85^\circ\text{C}$ (Package Type M) | Derate Linearly at 6 mW/ $^\circ\text{C}$ to 310 mW |
| OPERATING-TEMPERATURE RANGE (T_A): | |
| CD54 | -55 to $+125^\circ\text{C}$ |
| CD74 | -40 to $+85^\circ\text{C}$ |
| STORAGE TEMPERATURE (T_{Stg}) | |
| | -65 to $+150^\circ\text{C}$ |
| LEAD TEMPERATURE (DURING SOLDERING): | |
| At distance $1/16 \pm 1/32$ in. (1.59 ± 0.79 mm) from case for 10 s maximum. | $+265^\circ\text{C}$ |
| Unit inserted into PC board min. thickness $1/16$ in. (1.59 mm) with solder contacting lead tips only. | $+300^\circ\text{C}$ |

* For up to 4 outputs per device: add ± 25 mA for each additional output.

RECOMMENDED OPERATING CONDITIONS:

For maximum reliability, normal operating conditions should be selected so that operation is always within the following ranges:

| CHARACTERISTIC | LIMITS | | UNITS |
|---|--------|----------|------------------|
| | MIN. | MAX. | |
| Supply-Voltage Range, V_{CC} *: (For $T_A =$ Full Package-Temperature Range) AC Types ACT Types | 1.5 | 5.5 | V |
| | 4.5 | 5.5 | V |
| DC Input or Output Voltage, V_I, V_O | 0 | V_{CC} | V |
| Operating Temperature, T_A | CD54 | $+125$ | $^\circ\text{C}$ |
| | CD74 | $+85$ | |
| Input Rise and Fall Slew Rate, dt/dv at 1.5 V to 3 V (AC Types) at 3.6 V to 5.5 V (AC Types) at 4.5 V to 5.5 V (ACT Types) | 0 | 50 | ns/V |
| | 0 | 20 | ns/V |
| | 0 | 10 | ns/V |

* Unless otherwise specified, all voltages are referenced to ground.

9

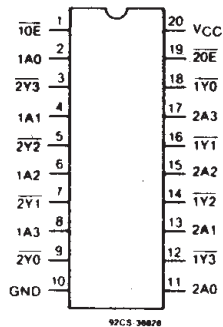

**CD54/74AC, ACT240 TYPES
TERMINAL ASSIGNMENT**

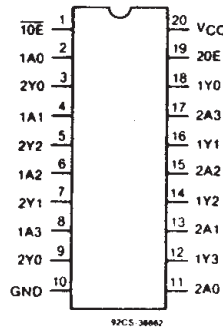

**CD54/74AC, ACT241 TYPES
TERMINAL ASSIGNMENT**

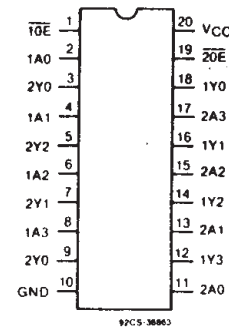

**CD54/74AC, ACT244 TYPES
TERMINAL ASSIGNMENT**

CD54/74AC240/241/244

CD54/74ACT240/241/244

STATIC ELECTRICAL CHARACTERISTICS: AC Series

| CHARACTERISTICS | TEST CONDITIONS | | V _{CC} (V) | AMBIENT TEMPERATURE (T _A) - °C | | | | | | UNITS |
|--|--|--|------------------------|--|------|------------|------|-------------|------|-------|
| | | | | +25 | | -40 to +85 | | -55 to +125 | | |
| | | | | MIN. | MAX. | MIN. | MAX. | MIN. | MAX. | |
| High-Level Input Voltage V _{IH} | | | 1.5 | 1.2 | — | 1.2 | — | 1.2 | — | V |
| | | | 3 | 2.1 | — | 2.1 | — | 2.1 | — | |
| | | | 5.5 | 3.85 | — | 3.85 | — | 3.85 | — | |
| Low-Level Input Voltage V _{IL} | | | 1.5 | — | 0.3 | — | 0.3 | — | 0.3 | V |
| | | | 3 | — | 0.9 | — | 0.9 | — | 0.9 | |
| | | | 5.5 | — | 1.65 | — | 1.65 | — | 1.65 | |
| High-Level Output Voltage V _{OH} | V _{IH} or V _{IL} | -0.05 | 1.5 | 1.4 | — | 1.4 | — | 1.4 | — | V |
| | | -0.05 | 3 | 2.9 | — | 2.9 | — | 2.9 | — | |
| | | -0.05 | 4.5 | 4.4 | — | 4.4 | — | 4.4 | — | |
| | | -4 | 3 | 2.58 | — | 2.48 | — | 2.4 | — | |
| | | -24 | 4.5 | 3.94 | — | 3.8 | — | 3.7 | — | |
| | | #, * | -75 | 5.5 | — | — | 3.85 | — | — | |
| Low-Level Output Voltage V _{OL} | V _{IH} or V _{IL} | 0.05 | 1.5 | — | 0.1 | — | 0.1 | — | 0.1 | V |
| | | 0.05 | 3 | — | 0.1 | — | 0.1 | — | 0.1 | |
| | | 0.05 | 4.5 | — | 0.1 | — | 0.1 | — | 0.1 | |
| | | 12 | 3 | — | 0.36 | — | 0.44 | — | 0.5 | |
| | | 24 | 4.5 | — | 0.36 | — | 0.44 | — | 0.5 | |
| | | #, * | 75 | 5.5 | — | — | — | 1.65 | — | |
| Input Leakage Current I _I | V _{CC} or GND | | 5.5 | — | ±0.1 | — | ±1 | — | ±1 | μA |
| | | | | | | | | | | |
| 3-State Leakage Current I _{OZ} | V _{IH} or V _{IL} | V _O = V _{CC} or GND | 5.5 | — | ±0.5 | — | ±5 | — | ±10 | μA |
| | | | | | | | | | | |
| Quiescent Supply Current, MSI I _{CC} | V _{CC} or GND | 0 | 5.5 | — | 8 | — | 80 | — | 160 | μA |

#Test one output at a time for a 1-second maximum duration. Measurement is made by forcing current and measuring voltage to minimize power dissipation.

*Test verifies a minimum 50-ohm transmission-line-drive capability at +85°C, 75 ohms at +125°C.

CD54/74AC240/241/244 CD54/74ACT240/241/244

STATIC ELECTRICAL CHARACTERISTICS: ACT Series

| CHARACTERISTICS | TEST CONDITIONS | | V _{CC} (V) | AMBIENT TEMPERATURE (T _A) - °C | | | | | | UNITS | |
|---|-----------------------|---|------------------------|--|------|------------|------|-------------|------|-------|----|
| | | | | +25 | | -40 to +85 | | -55 to +125 | | | |
| | V _I (V) | I _O (mA) | | MIN. | MAX. | MIN. | MAX. | MIN. | MAX. | | |
| High-Level Input Voltage | V _{IH} | | 4.5 to 5.5 | 2 | — | 2 | — | 2 | — | V | |
| Low-Level Input Voltage | V _{IL} | | 4.5 to 5.5 | — | 0.8 | — | 0.8 | — | 0.8 | V | |
| High-Level Output Voltage | V _{OH} | V _{IH} or V _{IL} #, * | -0.05 | 4.5 | 4.4 | — | 4.4 | — | 4.4 | — | V |
| | | | -24 | 4.5 | 3.94 | — | 3.8 | — | 3.7 | — | |
| | | | -75 | 5.5 | — | — | 3.85 | — | — | — | |
| | | | -50 | 5.5 | — | — | — | — | 3.85 | — | |
| Low-Level Output Voltage | V _{OL} | V _{IH} or V _{IL} #, * | 0.05 | 4.5 | — | 0.1 | — | 0.1 | — | 0.1 | V |
| | | | 24 | 4.5 | — | 0.36 | — | 0.44 | — | 0.5 | |
| | | | 75 | 5.5 | — | — | — | 1.65 | — | — | |
| | | | 50 | 5.5 | — | — | — | — | — | 1.65 | |
| Input Leakage Current | I _I | V _{CC} or GND | 5.5 | — | ±0.1 | — | ±1 | — | ±1 | μA | |
| 3-State Leakage Current | I _{OZ} | V _{IH} or V _{IL} V _O = V _{CC} or GND | 5.5 | — | ±0.5 | — | ±5 | — | ±10 | μA | |
| Quiescent Supply Current, MSI | I _{CC} | V _{CC} or GND | 0 | 5.5 | — | 8 | — | 80 | — | 160 | μA |
| Additional Quiescent Supply Current per Input Pin TTL Inputs High 1 Unit Load | ΔI _{CC} | V _{CC} -2.1 | 4.5 to 5.5 | — | 2.4 | — | 2.8 | — | 3 | mA | |

9

#Test one output at a time for a 1-second maximum duration. Measurement is made by forcing current and measuring voltage to minimize power dissipation.

*Test verifies a minimum 50-ohm transmission-line-drive capability at +85°C, 75 ohms at +125°C.

ACT INPUT LOADING TABLES

| CD54/74ACT240 | |
|---------------|-------------|
| INPUT | UNIT LOADS* |
| nA0 - A3 | 1.42 |
| 10E | 0.83 |
| 20E | 0.83 |

| CD54/74ACT241 | |
|---------------|-------------|
| INPUT | UNIT LOADS* |
| nA0 - A3 | 0.5 |
| 10E | 0.83 |
| 20E | 1.67 |

| CD54/74ACT244 | |
|---------------|-------------|
| INPUT | UNIT LOADS* |
| nA0 - A3 | 0.5 |
| 10E | 0.83 |
| 20E | 0.83 |

*Unit load is ΔI_{CC} limit specified in Static Characteristics Chart, e.g., 2.4 mA max. @ 25°C.

CD54/74AC240/241/244

CD54/74ACT240/241/244

SWITCHING CHARACTERISTICS: AC Series; $t_r, t_f = 3 \text{ ns}$, $C_L = 50 \text{ pF}$

| CHARACTERISTICS | SYMBOL | V_{CC} (V) | AMBIENT TEMPERATURE (T_A) - °C | | | | UNITS |
|--|----------------------------|-----------------|------------------------------------|------|-------------|------|-------|
| | | | -40 to +85 | | -55 to +125 | | |
| | | | MIN. | MAX. | MIN. | MAX. | |
| Propagation Delays: Data to Outputs AC240 | t_{PLH} | 1.5 | — | 82 | — | 90 | ns |
| | t_{PHL} | 3.3* | 2.6 | 9.2 | 2.5 | 10.1 | |
| AC241, 244 | t_{PLH} | 1.5 | — | 93 | — | 103 | ns |
| | t_{PHL} | 3.3 | 3 | 10.5 | 2.9 | 11.5 | |
| Output Enable Times | t_{PZL} | 1.5 | — | 136 | — | 150 | ns |
| | t_{PZH} | 3.3 | 4.6 | 16.4 | 4.5 | 18 | |
| Output Disable Times | t_{PLZ} | 1.5 | — | 136 | — | 150 | ns |
| | t_{PHZ} | 3.3 | 3.9 | 13.6 | 3.8 | 15 | |
| Power Dissipation Capacitance AC240 AC241, 244 | $C_{PD}\ddagger$ | — | 65 Typ. | | 65 Typ. | | pF |
| | | — | 71 Typ. | | 71 Typ. | | |
| Min. (Valley) V_{OH} During Switching of Other Outputs (Output Under Test Not Switching) | V_{OHV} See Fig. 1 | 5 | 4 Typ. @ 25°C | | | | V |
| Max. (Peak) V_{OL} During Switching of Other Outputs (Output Under Test Not Switching) | V_{OLP} See Fig. 1 | 5 | 1 Typ. @ 25°C | | | | V |
| Input Capacitance | C_i | — | — | 10 | — | 10 | pF |
| 3-State Output Capacitance | C_o | — | — | 15 | — | 15 | pF |

SWITCHING CHARACTERISTICS: ACT Series; $t_r, t_f = 3 \text{ ns}$, $C_L = 50 \text{ pF}$

| CHARACTERISTICS | SYMBOL | V_{CC} (V) | AMBIENT TEMPERATURE (T_A) - °C | | | | UNITS |
|--|----------------------------|-----------------|------------------------------------|------|-------------|------|-------|
| | | | -40 to +85 | | -55 to +125 | | |
| | | | MIN. | MAX. | MIN. | MAX. | |
| Propagation Delays: Data to Outputs ACT240 | t_{PLH} | 5† | 2.3 | 7.8 | 2.2 | 8.6 | ns |
| | t_{PHL} | 5† | 2.3 | 7.8 | 2.2 | 8.6 | |
| ACT241, 244 | t_{PLH} | 5 | 2.5 | 8.7 | 2.4 | 9.6 | ns |
| | t_{PHL} | 5 | 2.5 | 8.7 | 2.4 | 9.6 | |
| Output Enable Times | t_{PZL} | 5 | 3.5 | 12.2 | 3.4 | 13.4 | ns |
| | t_{PZH} | 5 | 3.5 | 12.2 | 3.4 | 13.4 | |
| Output Disable Times | t_{PLZ} | 5 | 3.5 | 12.2 | 3.4 | 13.4 | ns |
| | t_{PHZ} | 5 | 3.5 | 12.2 | 3.4 | 13.4 | |
| Power Dissipation Capacitance ACT240 ACT241, 244 | $C_{PD}\ddagger$ | — | 65 Typ. | | 65 Typ. | | pF |
| | | — | 71 Typ. | | 71 Typ. | | |
| Min. (Valley) V_{OH} During Switching of Other Outputs (Output Under Test Not Switching) | V_{OHV} See Fig. 1 | 5 | 4 Typ. @ 25°C | | | | V |
| Max. (Peak) V_{OL} During Switching of Other Outputs (Output Under Test Not Switching) | V_{OLP} See Fig. 1 | 5 | 1 Typ. @ 25°C | | | | V |
| Input Capacitance | C_i | — | — | 10 | — | 10 | pF |
| 3-State Output Capacitance | C_o | — | — | 15 | — | 15 | pF |

*3.3 V: min. is @ 3.6 V
max. is @ 3 V

†5 V: min. is @ 5.5 V
max. is @ 4.5 V

‡ C_{PD} is used to determine the dynamic power consumption, per package.

For AC series: $P_D = V_{CC}^2 f_i (C_{PD} + C_L)$

For ACT series: $P_D = V_{CC}^2 f_i (C_{PD} + C_L) + V_{CC} \Delta I_{CC}$ where f_i = input frequency

C_L = output load capacitance

V_{CC} = supply voltage.

Technical Data

CD54/74AC240/241/244 CD54/74ACT240/241/244

PARAMETER MEASUREMENT INFORMATION

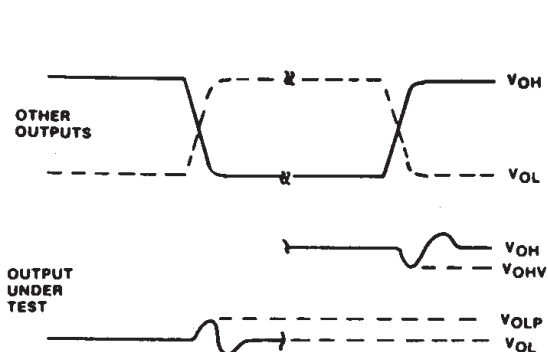

- NOTES:**
1. V_{OHV} and V_{OLP} ARE MEASURED WITH RESPECT TO A GROUND REFERENCE NEAR THE OUTPUT UNDER TEST.
 2. INPUT PULSES HAVE THE FOLLOWING CHARACTERISTICS:
PRR \leq 1 MHz, $t_r = 3$ ns, $t_f = 3$ ns, SKEW 1 ns.
 3. R.F. FIXTURE WITH 700-MHz DESIGN RULES REQUIRED. IC SHOULD BE SOLDERED INTO TEST BOARD AND BYPASSED WITH $0.1 \mu\text{F}$ CAPACITOR. SCOPE AND PROBES REQUIRE 700-MHz BANDWIDTH.

92CS-42406

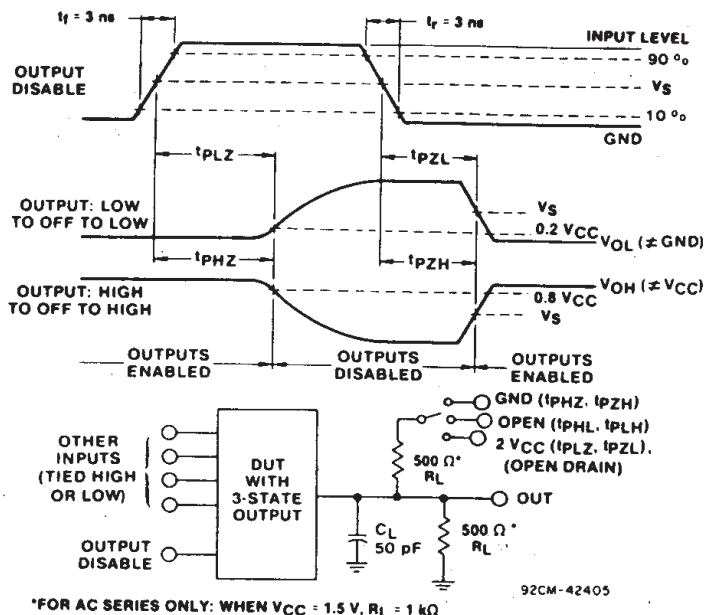

92CM-42405

Fig. 1 - Simultaneous switching transient waveforms.

Fig. 2 - Three-state propagation delay times and test circuit.

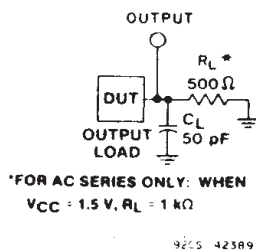

92CS-42389

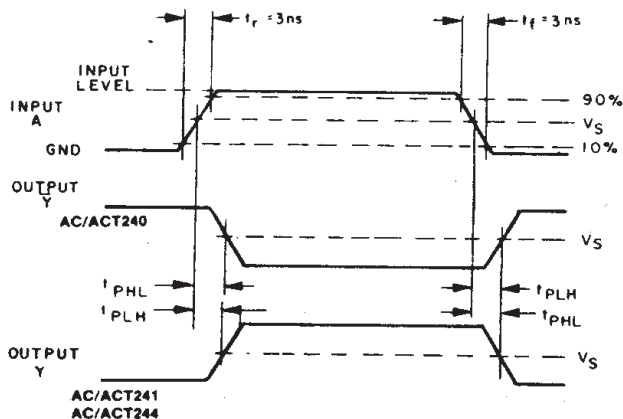

92CS-42407

Fig. 3 - Propagation delay times and test circuit.

| | CD54/74AC | CD54/74ACT |
|---------------------------------|--------------|--------------|
| Input Level | V_{CC} | 3 V |
| Input Switching Voltage, V_S | $0.5 V_{CC}$ | 1.5 V |
| Output Switching Voltage, V_S | $0.5 V_{CC}$ | $0.5 V_{CC}$ |

PACKAGING INFORMATION

| Orderable Device | Status (1) | Package Type | Package Drawing | Pins | Package Qty | Eco Plan (2) | Lead finish/ Ball material (6) | MSL Peak Temp (3) | Op Temp (°C) | Device Marking (4/5) | Samples |
|------------------|---------------|--------------|-----------------|------|-------------|------------------|--------------------------------------|----------------------|--------------|-------------------------|-------------------------|
| CD54AC240F3A | ACTIVE | CDIP | J | 20 | 1 | Non-RoHS & Green | SNPB | N / A for Pkg Type | -55 to 125 | CD54AC240F3A | Samples |
| CD54AC244F3A | ACTIVE | CDIP | J | 20 | 1 | Non-RoHS & Green | SNPB | N / A for Pkg Type | -55 to 125 | CD54AC244F3A | Samples |
| CD54ACT240F3A | ACTIVE | CDIP | J | 20 | 1 | Non-RoHS & Green | SNPB | N / A for Pkg Type | -55 to 125 | CD54ACT240F3A | Samples |
| CD54ACT241F3A | ACTIVE | CDIP | J | 20 | 1 | Non-RoHS & Green | SNPB | N / A for Pkg Type | -55 to 125 | CD54ACT241F3A | Samples |
| CD54ACT244F3A | ACTIVE | CDIP | J | 20 | 1 | Non-RoHS & Green | SNPB | N / A for Pkg Type | -55 to 125 | CD54ACT244F3A | Samples |
| CD74AC240E | ACTIVE | PDIP | N | 20 | 20 | RoHS & Green | NIPDAU | N / A for Pkg Type | -55 to 125 | CD74AC240E | Samples |
| CD74AC240EE4 | ACTIVE | PDIP | N | 20 | 20 | RoHS & Green | NIPDAU | N / A for Pkg Type | -55 to 125 | CD74AC240E | Samples |
| CD74AC240M | ACTIVE | SOIC | DW | 20 | 25 | RoHS & Green | NIPDAU | Level-1-260C-UNLIM | -55 to 125 | AC240M | Samples |
| CD74AC240M96 | ACTIVE | SOIC | DW | 20 | 2000 | RoHS & Green | NIPDAU | Level-1-260C-UNLIM | -55 to 125 | AC240M | Samples |
| CD74AC244E | ACTIVE | PDIP | N | 20 | 20 | RoHS & Green | NIPDAU | N / A for Pkg Type | -55 to 125 | CD74AC244E | Samples |
| CD74AC244M | ACTIVE | SOIC | DW | 20 | 25 | RoHS & Green | NIPDAU | Level-1-260C-UNLIM | -55 to 125 | AC244M | Samples |
| CD74AC244M96 | ACTIVE | SOIC | DW | 20 | 2000 | RoHS & Green | NIPDAU | Level-1-260C-UNLIM | -55 to 125 | AC244M | Samples |
| CD74ACT240E | ACTIVE | PDIP | N | 20 | 20 | RoHS & Green | NIPDAU | N / A for Pkg Type | -55 to 125 | CD74ACT240E | Samples |
| CD74ACT240M | ACTIVE | SOIC | DW | 20 | 25 | RoHS & Green | NIPDAU | Level-1-260C-UNLIM | -55 to 125 | ACT240M | Samples |
| CD74ACT240M96 | ACTIVE | SOIC | DW | 20 | 2000 | RoHS & Green | NIPDAU | Level-1-260C-UNLIM | -55 to 125 | ACT240M | Samples |
| CD74ACT240M96E4 | ACTIVE | SOIC | DW | 20 | 2000 | RoHS & Green | NIPDAU | Level-1-260C-UNLIM | -55 to 125 | ACT240M | Samples |
| CD74ACT241E | ACTIVE | PDIP | N | 20 | 20 | RoHS & Non-Green | NIPDAU | N / A for Pkg Type | -55 to 125 | CD74ACT241E | Samples |
| CD74ACT241M96 | ACTIVE | SOIC | DW | 20 | 2000 | RoHS & Green | NIPDAU | Level-1-260C-UNLIM | -55 to 125 | ACT241M | Samples |
| CD74ACT244E | ACTIVE | PDIP | N | 20 | 20 | RoHS & Green | NIPDAU | N / A for Pkg Type | -55 to 125 | CD74ACT244E | Samples |

| Orderable Device | Status (1) | Package Type | Package Drawing | Pins | Package Qty | Eco Plan (2) | Lead finish/ Ball material (6) | MSL Peak Temp (3) | Op Temp (°C) | Device Marking (4/5) | Samples |
|------------------|---------------|--------------|-----------------|------|-------------|-----------------|--------------------------------------|----------------------|--------------|-------------------------|-------------------------|
| CD74ACT244M | ACTIVE | SOIC | DW | 20 | 25 | RoHS & Green | NIPDAU | Level-1-260C-UNLIM | -55 to 125 | ACT244M | Samples |
| CD74ACT244M96 | ACTIVE | SOIC | DW | 20 | 2000 | RoHS & Green | NIPDAU | Level-1-260C-UNLIM | -55 to 125 | ACT244M | Samples |

(1) The marketing status values are defined as follows:

ACTIVE: Product device recommended for new designs.

LIFEBUY: TI has announced that the device will be discontinued, and a lifetime-buy period is in effect.

NRND: Not recommended for new designs. Device is in production to support existing customers, but TI does not recommend using this part in a new design.

PREVIEW: Device has been announced but is not in production. Samples may or may not be available.

OBSOLETE: TI has discontinued the production of the device.

(2) **RoHS:** TI defines "RoHS" to mean semiconductor products that are compliant with the current EU RoHS requirements for all 10 RoHS substances, including the requirement that RoHS substance do not exceed 0.1% by weight in homogeneous materials. Where designed to be soldered at high temperatures, "RoHS" products are suitable for use in specified lead-free processes. TI may reference these types of products as "Pb-Free".

RoHS Exempt: TI defines "RoHS Exempt" to mean products that contain lead but are compliant with EU RoHS pursuant to a specific EU RoHS exemption.

Green: TI defines "Green" to mean the content of Chlorine (Cl) and Bromine (Br) based flame retardants meet JS709B low halogen requirements of <=1000ppm threshold. Antimony trioxide based flame retardants must also meet the <=1000ppm threshold requirement.

(3) MSL, Peak Temp. - The Moisture Sensitivity Level rating according to the JEDEC industry standard classifications, and peak solder temperature.

(4) There may be additional marking, which relates to the logo, the lot trace code information, or the environmental category on the device.

(5) Multiple Device Markings will be inside parentheses. Only one Device Marking contained in parentheses and separated by a "~" will appear on a device. If a line is indented then it is a continuation of the previous line and the two combined represent the entire Device Marking for that device.

(6) Lead finish/Ball material - Orderable Devices may have multiple material finish options. Finish options are separated by a vertical ruled line. Lead finish/Ball material values may wrap to two lines if the finish value exceeds the maximum column width.

Important Information and Disclaimer:The information provided on this page represents TI's knowledge and belief as of the date that it is provided. TI bases its knowledge and belief on information provided by third parties, and makes no representation or warranty as to the accuracy of such information. Efforts are underway to better integrate information from third parties. TI has taken and continues to take reasonable steps to provide representative and accurate information but may not have conducted destructive testing or chemical analysis on incoming materials and chemicals. TI and TI suppliers consider certain information to be proprietary, and thus CAS numbers and other limited information may not be available for release.

In no event shall TI's liability arising out of such information exceed the total purchase price of the TI part(s) at issue in this document sold by TI to Customer on an annual basis.

OTHER QUALIFIED VERSIONS OF CD54AC240, CD54AC244, CD54ACT240, CD54ACT241, CD54ACT244, CD74AC240, CD74AC244, CD74ACT240, CD74ACT241, CD74ACT244 :

- Catalog : [CD74AC240](#), [CD74AC244](#), [CD74ACT240](#), [CD74ACT241](#), [CD74ACT244](#)
- Military : [CD54AC240](#), [CD54AC244](#), [CD54ACT240](#), [CD54ACT241](#), [CD54ACT244](#)

NOTE: Qualified Version Definitions:

- Catalog - TI's standard catalog product
- Military - QML certified for Military and Defense Applications

TAPE AND REEL INFORMATION

QUADRANT ASSIGNMENTS FOR PIN 1 ORIENTATION IN TAPE

*All dimensions are nominal

| Device | Package Type | Package Drawing | Pins | SPQ | Reel Diameter (mm) | Reel Width W1 (mm) | A0 (mm) | B0 (mm) | K0 (mm) | P1 (mm) | W (mm) | Pin1 Quadrant |
|---------------|--------------|-----------------|------|------|--------------------|--------------------|---------|---------|---------|---------|--------|---------------|
| CD74AC240M96 | SOIC | DW | 20 | 2000 | 330.0 | 24.4 | 10.8 | 13.3 | 2.7 | 12.0 | 24.0 | Q1 |
| CD74AC244M96 | SOIC | DW | 20 | 2000 | 330.0 | 24.4 | 10.8 | 13.3 | 2.7 | 12.0 | 24.0 | Q1 |
| CD74ACT240M96 | SOIC | DW | 20 | 2000 | 330.0 | 24.4 | 10.8 | 13.3 | 2.7 | 12.0 | 24.0 | Q1 |
| CD74ACT241M96 | SOIC | DW | 20 | 2000 | 330.0 | 24.4 | 10.8 | 13.3 | 2.7 | 12.0 | 24.0 | Q1 |
| CD74ACT244M96 | SOIC | DW | 20 | 2000 | 330.0 | 24.4 | 10.8 | 13.3 | 2.7 | 12.0 | 24.0 | Q1 |

TAPE AND REEL BOX DIMENSIONS

*All dimensions are nominal

| Device | Package Type | Package Drawing | Pins | SPQ | Length (mm) | Width (mm) | Height (mm) |
|---------------|--------------|-----------------|------|------|-------------|------------|-------------|
| CD74AC240M96 | SOIC | DW | 20 | 2000 | 367.0 | 367.0 | 45.0 |
| CD74AC244M96 | SOIC | DW | 20 | 2000 | 367.0 | 367.0 | 45.0 |
| CD74ACT240M96 | SOIC | DW | 20 | 2000 | 367.0 | 367.0 | 45.0 |
| CD74ACT241M96 | SOIC | DW | 20 | 2000 | 367.0 | 367.0 | 45.0 |
| CD74ACT244M96 | SOIC | DW | 20 | 2000 | 367.0 | 367.0 | 45.0 |

TUBE

*All dimensions are nominal

| Device | Package Name | Package Type | Pins | SPQ | L (mm) | W (mm) | T (μm) | B (mm) |
|--------------|--------------|--------------|------|-----|--------|--------|--------|--------|
| CD74AC240E | N | PDIP | 20 | 20 | 506 | 13.97 | 11230 | 4.32 |
| CD74AC240EE4 | N | PDIP | 20 | 20 | 506 | 13.97 | 11230 | 4.32 |
| CD74AC240M | DW | SOIC | 20 | 25 | 507 | 12.83 | 5080 | 6.6 |
| CD74AC244E | N | PDIP | 20 | 20 | 506 | 13.97 | 11230 | 4.32 |
| CD74AC244M | DW | SOIC | 20 | 25 | 507 | 12.83 | 5080 | 6.6 |
| CD74ACT240E | N | PDIP | 20 | 20 | 506 | 13.97 | 11230 | 4.32 |
| CD74ACT240M | DW | SOIC | 20 | 25 | 507 | 12.83 | 5080 | 6.6 |
| CD74ACT241E | N | PDIP | 20 | 20 | 506 | 13.97 | 11230 | 4.32 |
| CD74ACT244E | N | PDIP | 20 | 20 | 506 | 13.97 | 11230 | 4.32 |
| CD74ACT244M | DW | SOIC | 20 | 25 | 507 | 12.83 | 5080 | 6.6 |

N (R-PDIP-T**)

PLASTIC DUAL-IN-LINE PACKAGE

16 PINS SHOWN



- NOTES:
- A. All linear dimensions are in inches (millimeters).
 - B. This drawing is subject to change without notice.
 - $\triangle C$ Falls within JEDEC MS-001, except 18 and 20 pin minimum body length (Dim A).
 - $\triangle D$ The 20 pin end lead shoulder width is a vendor option, either half or full width.

4040049/E 12/2002

DW0020A



PACKAGE OUTLINE

SOIC - 2.65 mm max height

SOIC



4220724/A 05/2016

NOTES:

1. All linear dimensions are in millimeters. Dimensions in parenthesis are for reference only. Dimensioning and tolerancing per ASME Y14.5M.
2. This drawing is subject to change without notice.
3. This dimension does not include mold flash, protrusions, or gate burrs. Mold flash, protrusions, or gate burrs shall not exceed 0.15 mm per side.
4. This dimension does not include interlead flash. Interlead flash shall not exceed 0.43 mm per side.
5. Reference JEDEC registration MS-013.

EXAMPLE BOARD LAYOUT

DW0020A

SOIC - 2.65 mm max height

SOIC



LAND PATTERN EXAMPLE
SCALE:6X



SOLDER MASK DETAILS

4220724/A 05/2016

NOTES: (continued)

- 6. Publication IPC-7351 may have alternate designs.
- 7. Solder mask tolerances between and around signal pads can vary based on board fabrication site.

EXAMPLE STENCIL DESIGN

DW0020A

SOIC - 2.65 mm max height

SOIC



SOLDER PASTE EXAMPLE
BASED ON 0.125 mm THICK STENCIL
SCALE:6X

4220724/A 05/2016

NOTES: (continued)

8. Laser cutting apertures with trapezoidal walls and rounded corners may offer better paste release. IPC-7525 may have alternate design recommendations.
9. Board assembly site may have different recommendations for stencil design.

J (R-GDIP-T**)

14 LEADS SHOWN

CERAMIC DUAL IN-LINE PACKAGE



| DIM \ PINS ** | 14 | 16 | 18 | 20 |
|---------------|------------------------|------------------------|------------------------|------------------------|
| A | 0.300 (7,62) BSC | 0.300 (7,62) BSC | 0.300 (7,62) BSC | 0.300 (7,62) BSC |
| B MAX | 0.785 (19,94) | .840 (21,34) | 0.960 (24,38) | 1.060 (26,92) |
| B MIN | — | — | — | — |
| C MAX | 0.300 (7,62) | 0.300 (7,62) | 0.310 (7,87) | 0.300 (7,62) |
| C MIN | 0.245 (6,22) | 0.245 (6,22) | 0.220 (5,59) | 0.245 (6,22) |



4040083/F 03/03

- NOTES:
- All linear dimensions are in inches (millimeters).
 - This drawing is subject to change without notice.
 - This package is hermetically sealed with a ceramic lid using glass frit.
 - Index point is provided on cap for terminal identification only on press ceramic glass frit seal only.
 - Falls within MIL STD 1835 GDIP1-T14, GDIP1-T16, GDIP1-T18 and GDIP1-T20.

IMPORTANT NOTICE AND DISCLAIMER

TI PROVIDES TECHNICAL AND RELIABILITY DATA (INCLUDING DATA SHEETS), DESIGN RESOURCES (INCLUDING REFERENCE DESIGNS), APPLICATION OR OTHER DESIGN ADVICE, WEB TOOLS, SAFETY INFORMATION, AND OTHER RESOURCES "AS IS" AND WITH ALL FAULTS, AND DISCLAIMS ALL WARRANTIES, EXPRESS AND IMPLIED, INCLUDING WITHOUT LIMITATION ANY IMPLIED WARRANTIES OF MERCHANTABILITY, FITNESS FOR A PARTICULAR PURPOSE OR NON-INFRINGEMENT OF THIRD PARTY INTELLECTUAL PROPERTY RIGHTS.

These resources are intended for skilled developers designing with TI products. You are solely responsible for (1) selecting the appropriate TI products for your application, (2) designing, validating and testing your application, and (3) ensuring your application meets applicable standards, and any other safety, security, regulatory or other requirements.

These resources are subject to change without notice. TI grants you permission to use these resources only for development of an application that uses the TI products described in the resource. Other reproduction and display of these resources is prohibited. No license is granted to any other TI intellectual property right or to any third party intellectual property right. TI disclaims responsibility for, and you will fully indemnify TI and its representatives against, any claims, damages, costs, losses, and liabilities arising out of your use of these resources.

TI's products are provided subject to [TI's Terms of Sale](#) or other applicable terms available either on ti.com or provided in conjunction with such TI products. TI's provision of these resources does not expand or otherwise alter TI's applicable warranties or warranty disclaimers for TI products.

TI objects to and rejects any additional or different terms you may have proposed.

Mailing Address: Texas Instruments, Post Office Box 655303, Dallas, Texas 75265
Copyright © 2022, Texas Instruments Incorporated