

International
IOR Rectifier

QUIETIR Series
8EWF..S

**SURFACE MOUNTABLE
FAST SOFT RECOVERY
DIODE**

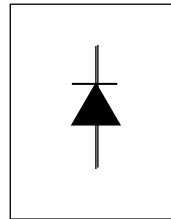

$V_F < 1.2V @ 8A$
 $t_{rr} = 55ns$
 $V_{RRM} 200 \text{ to } 600V$

Description/Features

The 8EWF..S fast soft recovery **QUIETIR** rectifier series has been optimized for combined short reverse recovery time, low forward voltage drop and low leakage current

The glass passivation ensures stable reliable operation in the most severe temperature and power cycling conditions.

Typical applications are both:

- Output rectification and freewheeling diode in inverters, choppers and converters.
- Input rectifications where severe restrictions on conducted EMI should be met.

Major Ratings and Characteristics

Characteristics	8EWF..S	Units
$I_{F(AV)}$ Sinusoidal waveform	8	A
V_{RRM}	200 to 600	V
I_{FSM}	170	A
$V_F @ 8A, T_J = 25^\circ C$	1.2	V
$t_{rr} @ 1A, 100A/\mu s$	55	ns
T_J	-40 to 150	$^\circ C$

Package Outline

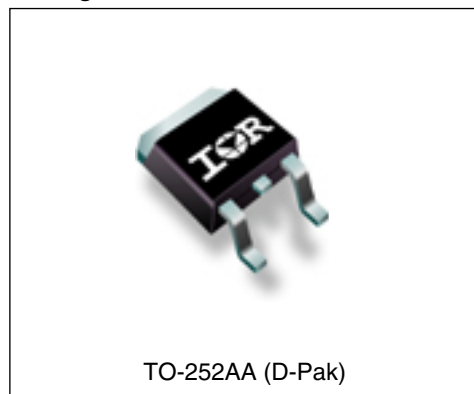

Voltage Ratings

Part Number	V_{RRM} , maximum peak reverse voltage V	V_{RSM} , maximum non repetitive peak reverse voltage V	I_{RRM} 150°C mA
8EWF02S	200	300	3
8EWF04S	400	500	
8EWF06S	600	700	

Absolute Maximum Ratings

Parameters	8EWF..S	Units	Conditions
$I_{F(AV)}$ Max. Average Forward Current	8	A	@ $T_C = 96^\circ\text{C}$, 180° conduction half sine wave
I_{FSM} Max. Peak One Cycle Non-Repetitive Surge Current	170	A	10ms Sine pulse, rated V_{RRM} applied
	200		10ms Sine pulse, no voltage reappplied
I^2t Max. I^2t for fusing	140	A^2s	10ms Sine pulse, rated V_{RRM} applied
	200		10ms Sine pulse, no voltage reappplied
$I^2\sqrt{t}$ Max. $I^2\sqrt{t}$ for fusing	2000	A^2/\sqrt{s}	$t = 0.1$ to 10ms, no voltage reappplied

Electrical Specifications

Parameters	8EWF..S	Units	Conditions
V_{FM} Max. Forward Voltage Drop	1.2	V	@ 8A, $T_J = 25^\circ\text{C}$
r_t Forward slope resistance	16	$m\Omega$	$T_J = 150^\circ\text{C}$
$V_{F(TO)}$ Threshold voltage	1.13	V	
I_{RM} Max. Reverse Leakage Current	0.1	mA	$T_J = 25^\circ\text{C}$
	3		$T_J = 150^\circ\text{C}$

$V_R = \text{rated } V_{RRM}$

Typical Reverse Recovery Characteristics

Parameters	8EWF..S	Units	Conditions
t_{rr} Reverse Recovery Time	140	ns	$I_F @ 8A_{pk}$ @ $25A/\mu s$ @ $T_J = 25^\circ\text{C}$
I_{rr} Reverse Recovery Current	2.6	A	
Q_{rr} Reverse Recovery Charge	0.25	μC	
S Snap Factor t_b/t_a	0.5	-	

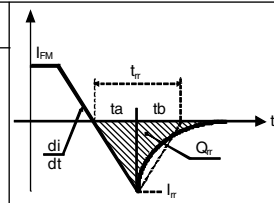

Thermal-Mechanical Specifications

Parameters	8EWF..S	Units	Conditions
T _J Max. Junction Temperature Range	-40 to 150	°C	
T _{stg} Max. Storage Temperature Range	-40 to 150	°C	
R _{thJC} Max. Thermal Resistance Junction to Case	2.5	°C/W	DC operation
R _{thJA} Typ. Thermal Resistance Junction to Ambient (PCB Mount)**	50	°C/W	
wt Approximate Weight	1(0.03)	g(oz.)	
Case Style	TO-252AA (D-Pak)		

**When mounted on 1" square (650mm²) PCB of FR-4 or G-10 material 4 oz (140µm) copper 40°C/W
 For recommended footprint and soldering techniques refer to application note #AN-994

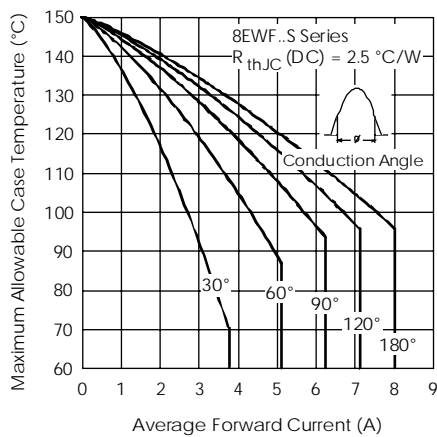

Fig. 1 - Current Rating Characteristics

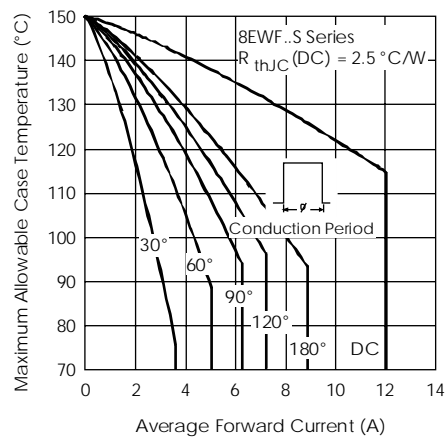

Fig. 2 - Current Rating Characteristics

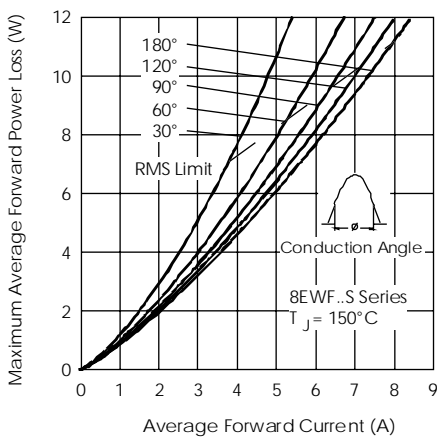

Fig. 3 - Forward Power Loss Characteristics

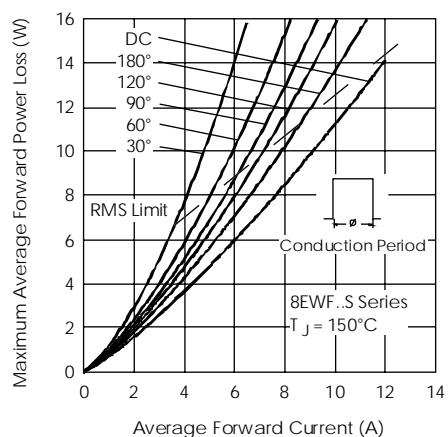

Fig. 4 - Forward Power Loss Characteristics

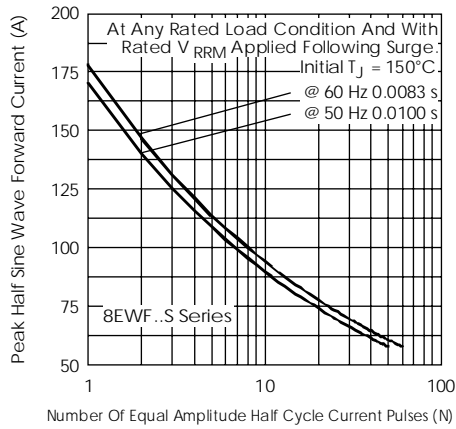

Fig.5-Maximum Non-Repetitive Surge Current

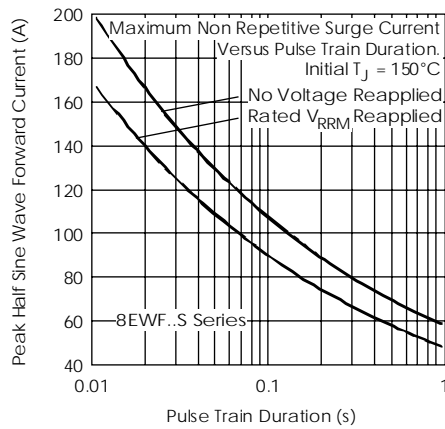

Fig.6-Maximum Non-Repetitive Surge Current

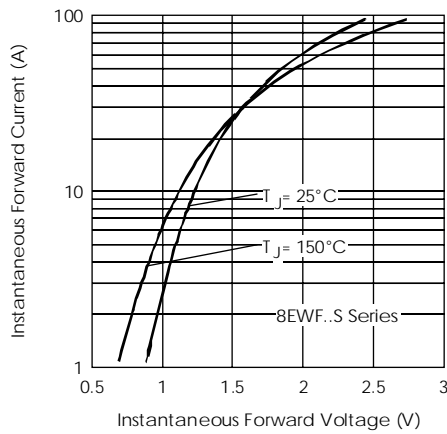

Fig.7-Forward Voltage Drop Characteristics

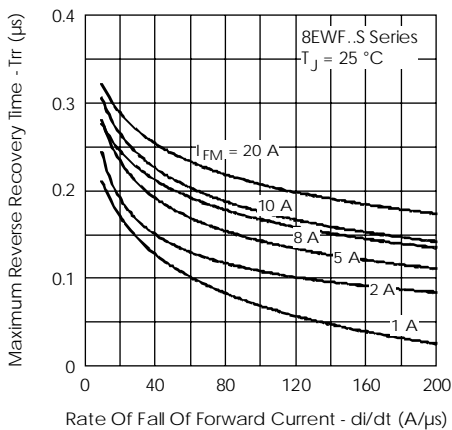

Fig.8-Recovery Time Characteristics, $T_J = 25^\circ\text{C}$

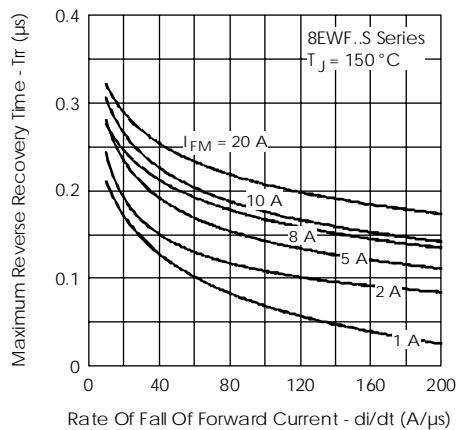

Fig.9-Recovery Time Characteristics, $T_J = 150^\circ\text{C}$

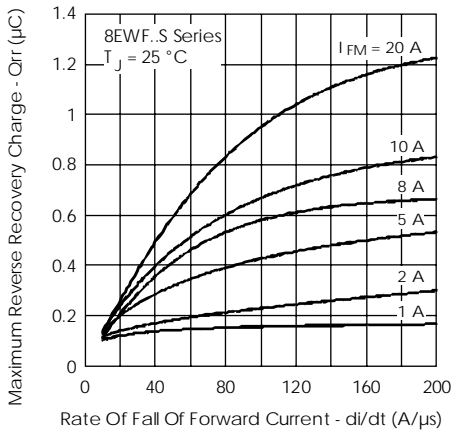

Fig. 10-Recovery Charge Characteristics, T_J=25°C

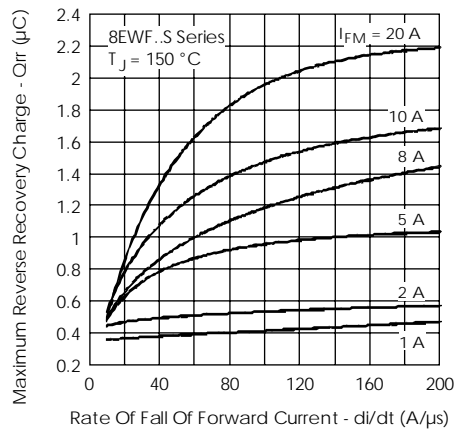

Fig. 11-Recovery Charge Characteristics, T_J=150°C

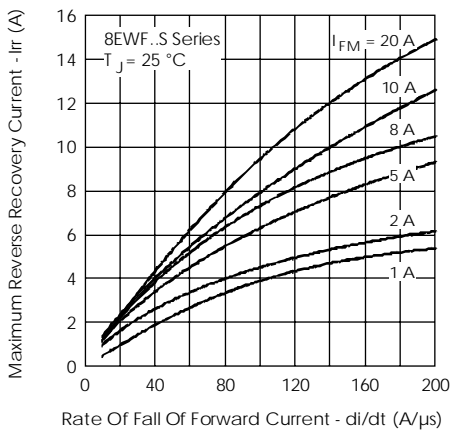

Fig. 12-Recovery Current Characteristics, T_J=25°C

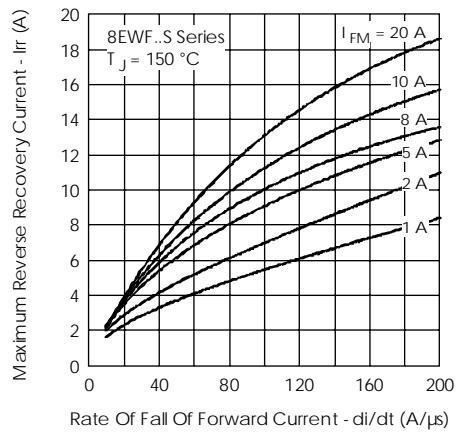

Fig. 13-Recovery Current Characteristics, T_J=150°C

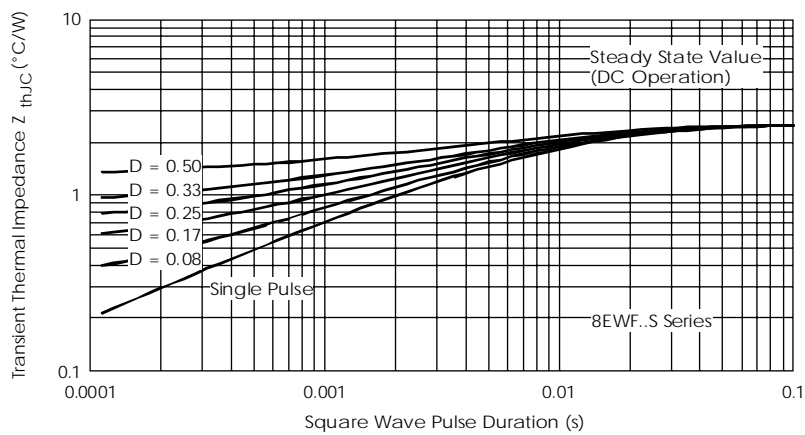

Fig. 14-Thermal Impedance Z_{thJC} Characteristics

Ordering Information Table

Device Code

8	E	W	F	06	S	TRL
1	2	3	4	5	6	7

8 = 800V Peak Inverse Voltage
E = Single-Diode
W = Single-Diode Recovery Rectifier
F = Fast Recovery Diode
S = Schottky Rectifier
TRL = Left Orientation Reel
TRR = Right Orientation Reel

02 = 200V
04 = 400V
06 = 600V

Outline Table

Dimensions in millimeters and (inches)

MINIMUM RECOMMENDED FOOTPRINT

1 - Anode
 2 - Cathode
 3 - Anode
 4 - Cathode

Marking Information

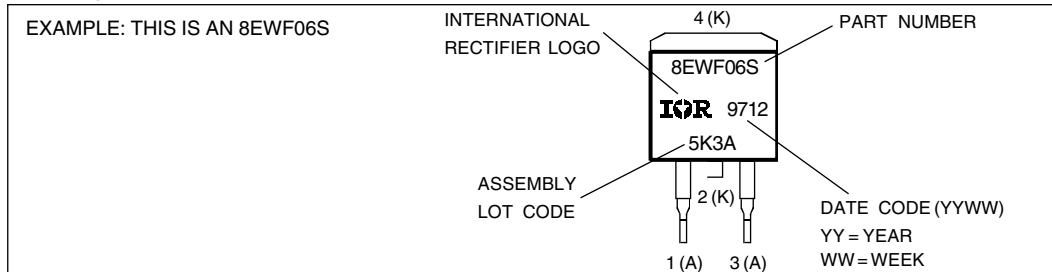

Tape & Reel Information

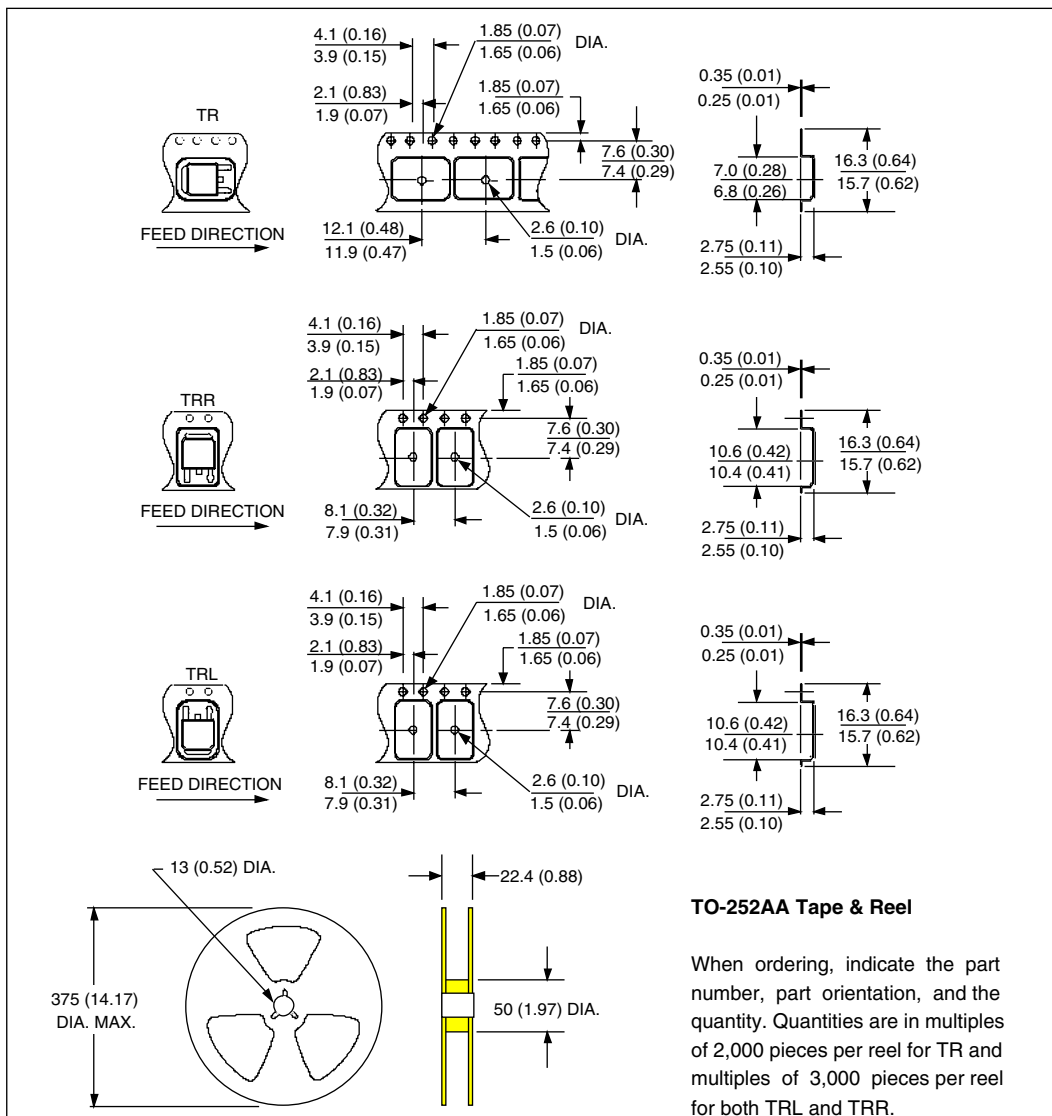

International
IOR Rectifier

WORLD HEADQUARTERS: 233 Kansas St., El Segundo, California 90245 U.S.A. Tel: (310) 322 3331. Fax: (310) 322 3332.
EUROPEAN HEADQUARTERS: Hurst Green, Oxted, Surrey RH8 9BB, U.K. Tel: ++ 44 1883 732020. Fax: ++ 44 1883 733408.
IR CANADA: 15 Lincoln Court, Brampton, Markham, Ontario L6T3Z2. Tel: (905) 453 2200. Fax: (905) 475 8801.
IR GERMANY: Saalburgstrasse 157, 61350 Bad Homburg. Tel: ++ 49 6172 96590. Fax: ++ 49 6172 965933.
IR ITALY: Via Liguria 49, 10071 Borgaro, Torino. Tel: ++ 39 11 4510111. Fax: ++ 39 11 4510220.
IR FAR EAST: K&H Bldg., 2F, 30-4 Nishi-Ikebukuro 3-Chome, Toshima-Ku, Tokyo, Japan 171. Tel: 81 3 3983 0086.
IR SOUTHEAST ASIA: 1 Kim Seng Promenade, Great World City West Tower, 13-11, Singapore 237994. Tel: ++ 65 838 4630.
IR TAIWAN: 16 Fl. Suite D.207, Sec. 2, Tun Haw South Road, Taipei, 10673, Taiwan. Tel: 886 2 2377 9936.

Data and specifications subject to change without notice.



Notice

The products described herein were acquired by Vishay Intertechnology, Inc., as part of its acquisition of International Rectifier's Power Control Systems (PCS) business, which closed in April 2007. Specifications of the products displayed herein are pending review by Vishay and are subject to the terms and conditions shown below.

Specifications of the products displayed herein are subject to change without notice. Vishay Intertechnology, Inc., or anyone on its behalf, assumes no responsibility or liability for any errors or inaccuracies.

Information contained herein is intended to provide a product description only. No license, express or implied, by estoppel or otherwise, to any intellectual property rights is granted by this document. Except as provided in Vishay's terms and conditions of sale for such products, Vishay assumes no liability whatsoever, and disclaims any express or implied warranty, relating to sale and/or use of Vishay products including liability or warranties relating to fitness for a particular purpose, merchantability, or infringement of any patent, copyright, or other intellectual property right.

The products shown herein are not designed for use in medical, life-saving, or life-sustaining applications. Customers using or selling these products for use in such applications do so at their own risk and agree to fully indemnify Vishay for any damages resulting from such improper use or sale.

International Rectifier®, IR®, the IR logo, HEXFET®, HEXSense®, HEXDIP®, DOL®, INTERO®, and POWIRTRAIN® are registered trademarks of International Rectifier Corporation in the U.S. and other countries. All other product names noted herein may be trademarks of their respective owners.