

NOTES:

1. ROHS COMPLIANT
2. HEADER: THERMOSET PLASTIC MATERIAL WITH FLAMMABILITY RATING UL 94V-0 OR BETTER.
3. STORAGE TEMPERATURE: -50°C TO +125°C
4. COMPLIANCE TO J-STD:
 - A. J-STD-002: SOLDERABILITY AT 245°C REFLOW PROFILE
 - B. J-STD-020: LEVEL 1, NO MOISTURE SENSITIVE
 - C. J-STD-075: R7, 245°C MAXIMUM THROUGH REFLOW SOLDER
5. TO ORDER TAPE & REEL PACKAGING ADD A "T" SUFFIX TO THE PART NUMBER(i.e HX1198NL BECOMES HX1198NLT).

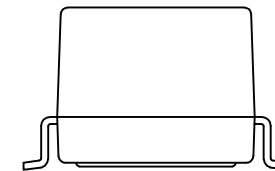
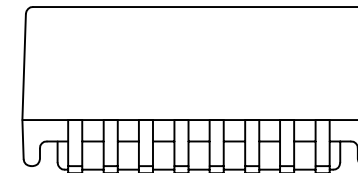
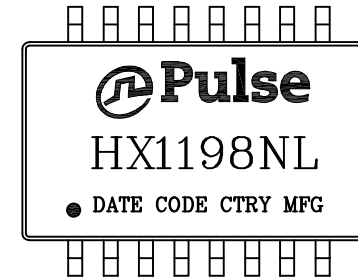

FINAL OUTLINE

© Copyright, 2015. Pulse Electronics Corp. All rights reserved. Pulse confidential & proprietary. (07/30/15)

PRODUCT DESCRIPTION	TLA DRAWING	PS DRAWING	SHEET	PART NO.	DATASHEET REV.
MDL,SIN,100D,1:1,SMT	HX1198NL-12	PS-2005.001-F	1 OF 3	HX1198NL	A

ELECTRICAL CHARACTERISTICS AT +25°C UNLESS OTHER SPECIFIED
MEETS IEEE 802.3 SPECIFICATION

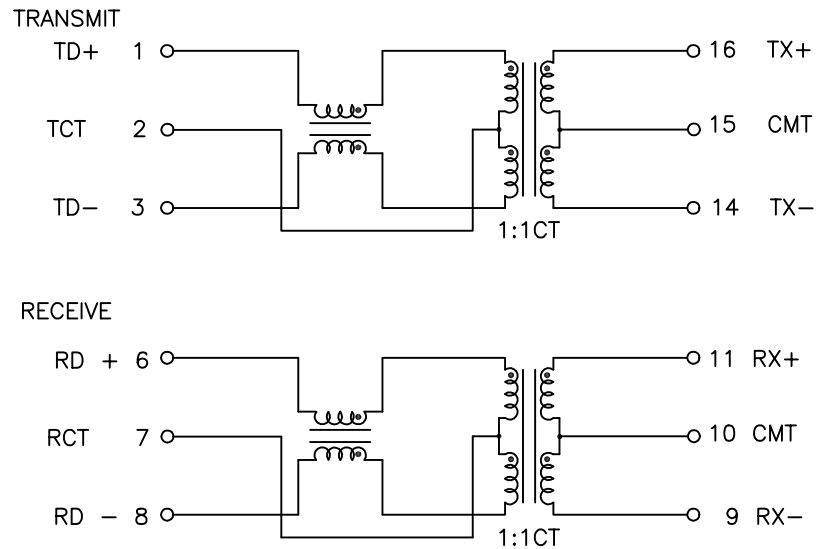

SCHEMATIC

PARAMETER	SPECIFICATIONS	
OPERATING TEMP	-40°C ~ +85°C	
TURNS RATIO	1 : 1 ± 2%	
POLARITY	PER SCHEMATIC	
INSERTION LOSS	100 KHz	1-125 MHz
	-1.2 dB MAX	-0.2-0.002*f ^{1.4} dB MAX
RETURN LOSS (Z OUT = 100 OHM±15%)	5MHz	30-80MHz
	-18 dB MIN	-16 + 26LOG ₁₀ (f/30MHz) dB MIN
INDUCTANCE (OCL) (MEDIA SIDE, -40°C ~ +85°C)	350 uH MIN (MEASURED AT 100 KHz, 100 mVRMS) (AND WITH 8 mA DC BIAS)	
CROSSTALK (TX-RX)	1 MHz	5-100MHz
	-62 dB MIN	-45 + 21LOG ₁₀ (f/30MHz) dB MIN
DIFFERENTIAL TO COMMON MODE REJECTION	5-200MHz	
	-50+17LOG ₁₀ (f/5MHz) dB MIN	
ISOLATION (INPUT - OUTPUT)	1500 VRMS MIN @ 60 SECONDS	

NOTE: f IS FREQUENCY IN MHz.

© Copyright, 2015. Pulse Electronics Corp. All rights reserved. Pulse confidential & proprietary. (07/30/15)

PRODUCT DESCRIPTION	TLA DRAWING	PS DRAWING	SHEET	PART NO.	DATASHEET REV.
MDL,SIN,100D,1:1,SMT	HX1198NL-12	PS-2005.001-F	2 OF 3	HX1198NL	A

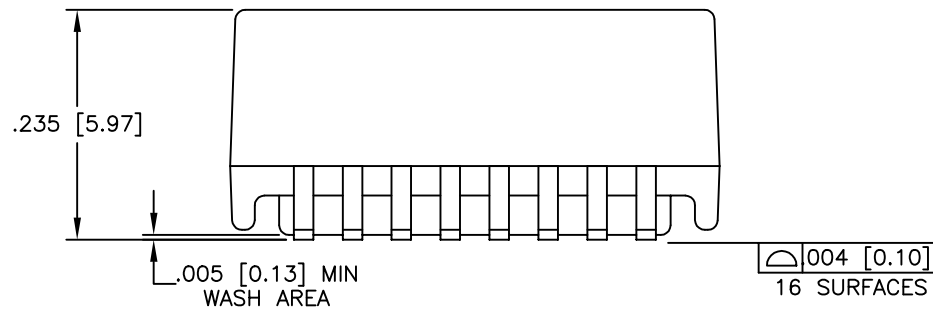
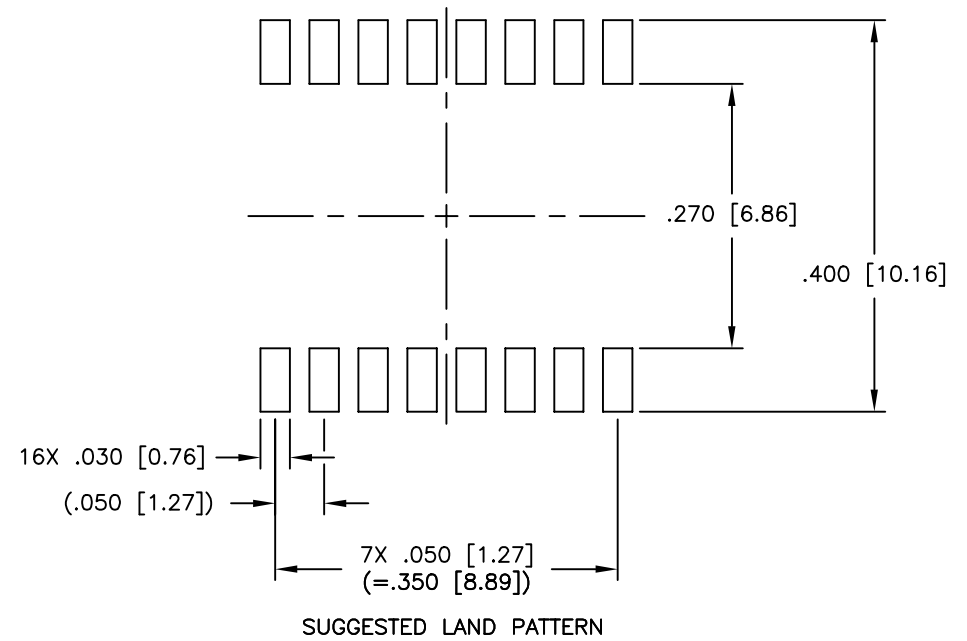
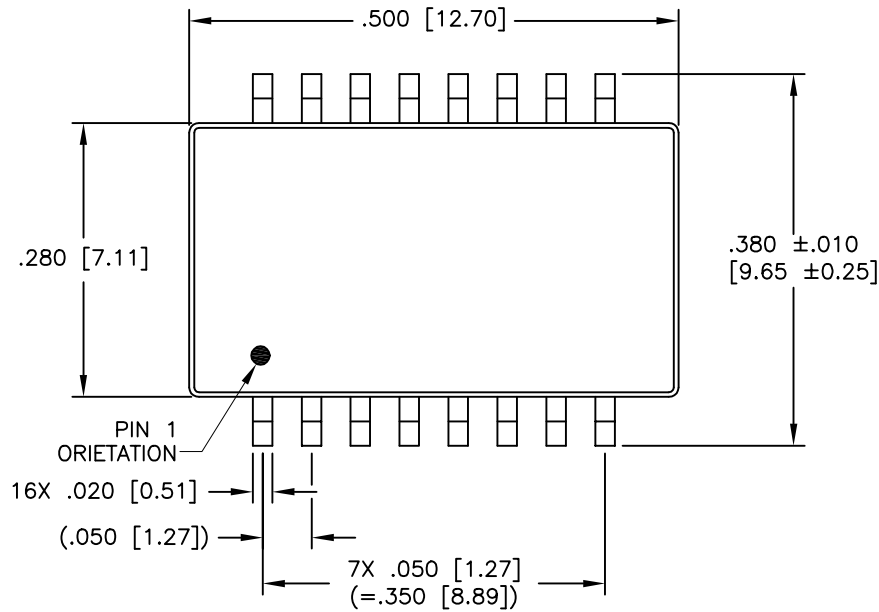

DIMENSIONS ARE IN INCHES [MILLIMETERS] WITH THE FOLLOWING TOLERANCES: [MILLIMETERS] ARE FOR REFERENCE ONLY.
 .XX= ±.01 [±0.25]
 .XXX= ±.005 [±0.13]

© Copyright, 2015. Pulse Electronics Corp. All rights reserved. Pulse confidential & proprietary. (07/30/15)

PRODUCT DESCRIPTION	TLA DRAWING	PS DRAWING	SHEET	PART NO.	DATASHEET REV.
MDL,SIN,100D,1:1,SMT	HX1198NL-12	PS-2005.001-F	3 OF 3	HX1198NL	A