

High Side Load Switch with Low Supply Current

■ GENERAL DESCRIPTION

The XC8101 series is a low supply current load switch IC with ON/OFF control and output current protection which integrates P-channel MOSFET. The XC8101 is suited for power distribution switch. With connecting to the output pin of step-down DC/DC converters, the CE pin controls ON/OFF for each distribution switch to deliver power per requirements and maximize total power efficiency. As result, the XC8101 helps extend battery life and product operation time.

The XC8101 is available in an ultra small package USP-4 and does not require any external capacitors so that it can provide small power unit design and board space saving.

When low signal is input to the CE pin, the XC8101 enters stand-by mode. Even where a load capacitor is connected to the output pin during in the stand-by mode, the internal switch between the V_{OUT} and V_{SS} of the XC8101 enables the electric charge in the load capacitor to be discharged. Because of this discharge function, the V_{OUT} pin voltage falls quickly to V_{SS} level.

The XC8101 contains an over current protection with foldback current circuitry which operates as over current protection and short circuit protection for the output pin.

■ APPLICATIONS

- Smart phones / Mobile phones
- Digital still cameras / Camcorders
- Portable game consoles

■ FEATURES

On Resistance	: 0.75Ω@ $V_{IN}=2.9V$ (TYP.) : 1.15Ω@ $V_{IN}=1.8V$ (TYP.)
Output Current	: 200mA <Current Limit =300mA (TYP.)>
Input Voltage Range	: 1.8V ~ 6.0V
Power Consumption	: 3.0 μA@ $V_{IN}=1.8V$
Stand-by Current	: 0.1 μA
Protection Circuit	: Current limit, 300mA (TYP.) : Short-circuit Protection, Short current= 30mA (TYP.)
ON/OFF Function	: High Active Enable
High-Speed Discharge Function	
Operating Temperature Range	: -40°C ~ 85°C
Packages	: USP-4, SSOT-24, SOT-25
Environmentally Friendly	: EU RoHS Compliant, Pb Free

■ TYPICAL APPLICATION CIRCUIT

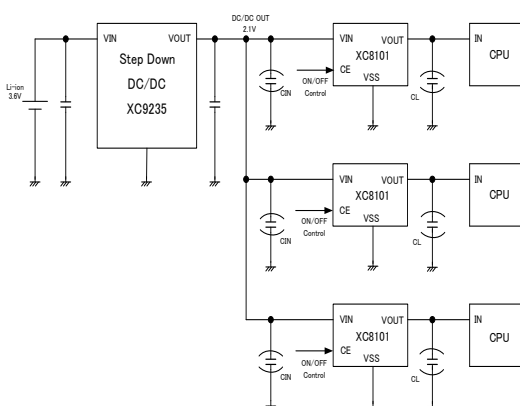

■ TYPICAL PERFORMANCE CHARACTERISTICS

- Supply Current vs. Input Voltage

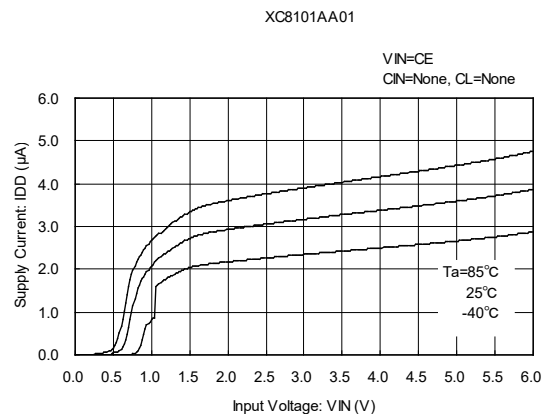

■ BLOCK DIAGRAM

● XC8101AA Series

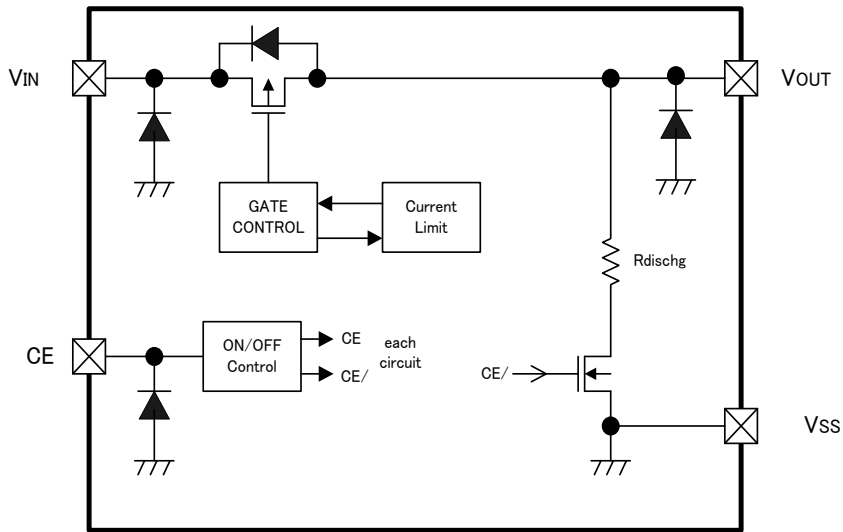

* Diodes inside the circuit are an ESD protection diode and a parasitic diode.

■ PRODUCT CLASSIFICATION

● Ordering Information

XC8101①②③④⑤⑥-⑦^(*)

DESIGNATOR	ITEM	SYMBOL	DESCRIPTION
①	CE pin logic	A	High active enable
②	C _L Discharge Function	A	Output capacitor (C _L) auto-discharge function integrated
③④	Internal Standard Number	01	Fixed
⑤⑥-⑦ ^(*)	Packages (Order Unit)	GR-G	USP-4 (3,000pcs/Reel)
		MR-G	SOT-25 (3,000pcs/Reel)
		NR-G	SSOT-24 (3,000pcs/Reel)

^(*) The "-G" suffix indicates that the products are Halogen and Antimony free as well as being fully EU RoHS compliant.

■ PIN CONFIGURATION

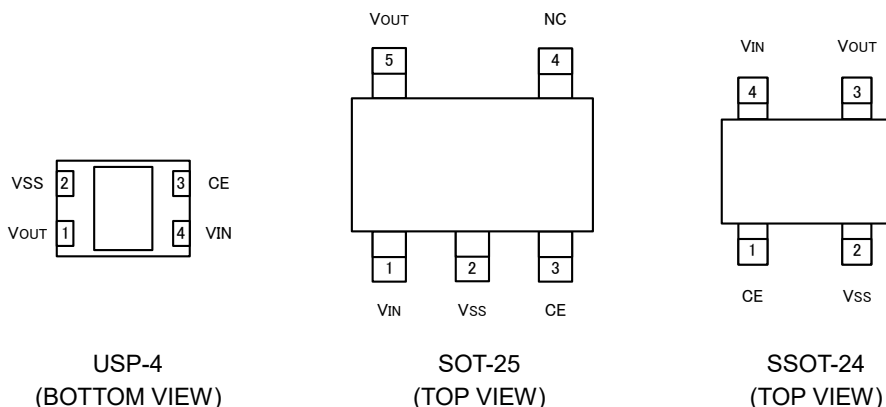

*The heat dissipation pad of the USP-4 package is recommended to solder as shown in the recommended mount pattern and metal mask pattern for mounting strength. The heat dissipation pad should be electrically opened or connected to the V_{SS} (No. 2) pin.

■ PIN ASSIGNMENT

PIN NUMBER			PIN NAME	FUNCTIONS
USP-4	SOT-25	SSOT-24		
4	1	4	V _{IN}	Power Input
1	5	3	V _{OUT}	Output
2	2	2	V _{SS}	Ground
3	3	1	CE	ON/OFF Control
-	4	-	NC	No Connection

■ FUNCTION CHART

SERIES	CE	IC OPERATIONAL STATUS ON/OFF
XC8101AA01	High	ON
	Low	OFF

■ ABSOLUTE MAXIMUM RATINGS

PARAMETER	SYMBOL	RATINGS	UNITS
Input Voltage	V _{IN}	V _{SS} - 0.3 ~ 6.5	V
Output Current	I _{OUT}	450 ^(*)	mA
Output Voltage	V _{OUT}	V _{SS} - 0.3 ~ V _{IN}	V
CE Input Voltage	V _{CE}	V _{SS} - 0.3 ~ 6.5	V
Power Dissipation (Ta=25°C)	USP-4	120	mW
		1000 (40mm x 40mm Standard Board) ^(**)	
	SSOT-24	150	
		500 (40mm x 40mm Standard Board) ^(**)	
	SOT-25	680 (JESD51-7 Board) ^(**)	
		760 (JESD51-7 Board) ^(**)	
Operating Temperature Range	Topr	-40 ~ 85	°C
Storage Temperature Range	Tstg	-55 ~ 125	°C

^(*) Please make sure that I_{OUT} is less than Pd/(V_{IN}-V_{OUT}).

^(**) The power dissipation figure shown is PCB mounted and is for reference only.
Please refer to PACKAGING INFORMATION for the mounting condition.

ELECTRICAL CHARACTERISTICS

●XC8101AA Series

Ta=25°C

PARAMETER	SYMBOL	CONDITIONS	MIN.	TYP.	MAX.	UNITS	CIRCUIT
Input Voltage	V _{IN}		1.8	-	6.0	V	-
On Resistance (SSOT-24 / USP-4)	R _{ON}	V _{IN} =6.0V, V _{CE} =V _{IN}	-	0.55	0.90	Ω	①
		V _{IN} =4.0V, V _{CE} =V _{IN}	-	0.65	1.00		
		V _{IN} =2.9V, V _{CE} =V _{IN}	-	0.75	1.10		
		V _{IN} =1.8V, V _{CE} =V _{IN}	-	1.15	1.50		
On Resistance (SOT-25)	R _{ON}	V _{IN} =6.0V, V _{CE} =V _{IN}	-	0.65	1.00	Ω	①
		V _{IN} =4.0V, V _{CE} =V _{IN}	-	0.75	1.10		
		V _{IN} =2.9V, V _{CE} =V _{IN}	-	0.85	1.20		
		V _{IN} =1.8V, V _{CE} =V _{IN}	-	1.25	1.60		
Supply Current	I _{DD}	V _{IN} =6.0V, V _{CE} =V _{IN} , V _{OUT} =OPEN	-	2.7	8.2	μA	②
		V _{IN} =4.0V, V _{CE} =V _{IN} , V _{OUT} =OPEN	-	2.3	7.3		
		V _{IN} =2.9V, V _{CE} =V _{IN} , V _{OUT} =OPEN	-	2.2	6.9		
		V _{IN} =1.8V, V _{CE} =V _{IN} , V _{OUT} =OPEN	-	2.0	6.2		
Stand-by Current	I _{STBY}	V _{IN} =6.0V, V _{CE} =V _{SS} , V _{OUT} =OPEN	-	0.01	0.10	μA	②
Switch Leakage Current	I _{LEAK}	V _{IN} =6.0V, V _{CE} =V _{OUT} =V _{SS}	-	0.01	0.10	μA	②
Current Limit	I _{LIM}	V _{CE} =V _{IN} , V _{OUT} =V _{IN} -1.0V	200	300	-	mA	①
Short Circuit Current	I _{SHORT}	V _{CE} =V _{IN} , V _{OUT} =0V	-	30	-	mA	①
CE High Level Voltage	V _{CEH}		1.2	-	6.0	V	③
CE Low Level Voltage	V _{CEL}		V _{SS}	-	0.3	V	③
CE High Level Current	I _{CEH}	V _{CE} =V _{IN}	-0.1	-	0.1	μA	③
CE Low Level Current	I _{CEL}	V _{CE} =V _{SS}	-0.1	-	0.1	μA	③
CL Auto-Discharge Resistance	R _{DCHG}	V _{IN} =4.0V, V _{OUT} =4.0V, V _{CE} =V _{SS}	650	900	1100	Ω	④
Turn On Time (*1)	t _{DLY(ON)}	V _{IN} =4.0V, V _{CE} =0.3V→1.2V, R _L =80Ω, without C _{IN} , C _L	-	6	13	μs	⑤
Turn Off Time (*2)	t _{DLY(OFF)}	V _{IN} =4.0V, V _{CE} =1.2V→0.3V, R _L =80Ω, without C _{IN} , C _L	-	2.0	4.0	μs	⑤

NOTE:

*1: Time to reach 90% of V_{OUT} after V_{CE} entering the V_{CEH} threshold.

*2: Time to fall to 10% of V_{OUT} after V_{CE} entering the V_{CEL} threshold.

TEST CIRCUITS

Circuit ①

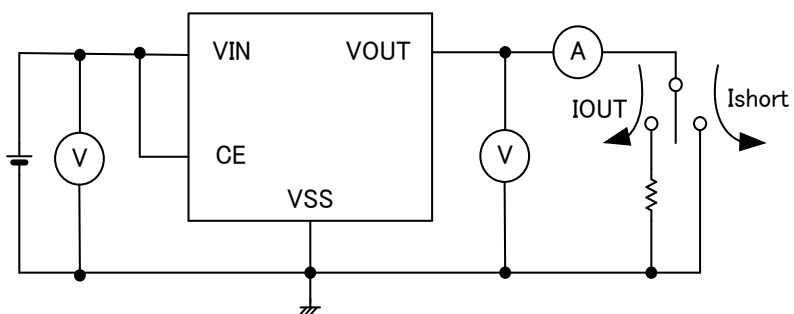

Circuit ②

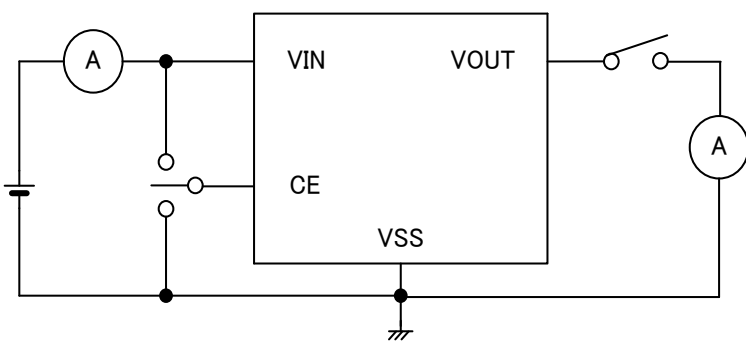

Circuit ③

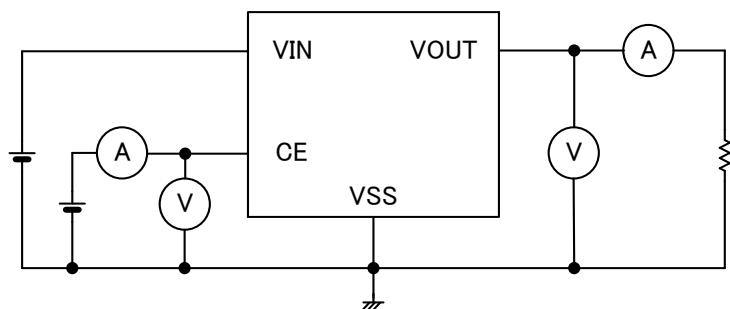

TEST CIRCUITS (Continued)

Circuit ④

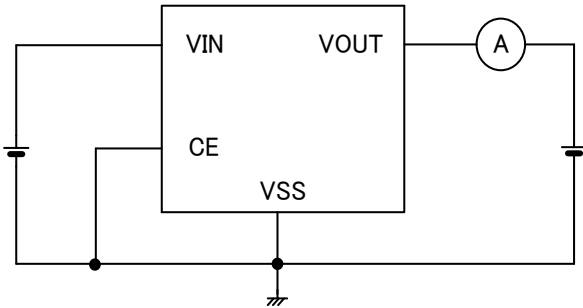

Circuit ⑤

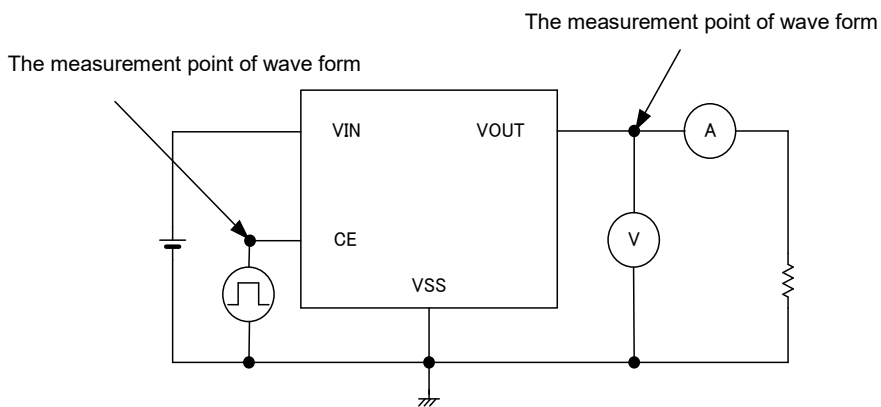

■ OPERATIONAL EXPLANATION

<CE Pin>

The XC8101 enables an output P-channel MOSFET switch and the IC internal circuitry to turn off by the signal to the CE pin. In the shutdown mode, the V_{OUT} pin will be pulled down to the V_{SS} by the C_L auto-discharge function.

The output voltage becomes unstable when the CE pin is opened. If the input voltage to the CE pin is within the specified threshold voltages, the logic is fixed and the XC8101 will operate normally. However, supply current may increase as a result of the shoot-through current of internal circuitry when the medium level voltage is input to the CE pin.

<Input Capacitor>

The XC8101 works well without an output capacitor (C_L). However, an output capacitor such as a bypass capacitor is tied up to the output side of the IC, input voltage ringing may occur when the IC is turned on. In order to reduce the ringing, an input capacitor with the value of 1 μF or more is requested to attach between V_{IN} pin and V_{SS} pin. The capacitor should be tied and placed as close as the IC.

<CL Auto-Discharge Function>

The XC8101A contains a C_L auto-discharge resistor and an N-channel transistor between the V_{OUT} pin and the V_{SS} pin. The XC8101A quickly discharge the electric charge in the output capacitor (C_L) when a low signal to the CE pin is input to turn off a whole IC circuit. The C_L auto-discharge resistance is set at 900Ω (V_{OUT}=4.0V TYP. @ V_{IN}=4.0). Discharge time of the output capacitor (C_L) is determined by a C_L auto-discharge resistor value (R_{DCHG}) and an output capacitor value. Time constant τ is defined as (τ = C × R_{DCHG}). Output voltage after starting discharge can be calculated by the following formula.

$$V = V_{OUT} \times e^{-t/\tau}, \quad \text{or} \quad t = \tau \ln(V_{OUT} / V)$$

V: Output voltage after starting discharge

V_{OUT}: Output voltage

t: Discharge time

τ : Output discharge resistor value R_{dischg} × Output capacitor (C_L) value C

<Current Limiter, Short-Circuit Protection>

The XC8101 series contains a constant current limiter and foldback current circuitry. The constant current limiter operates to limit output current and the foldback current circuitry operates as short circuit protection for the output pin.

When the load current reaches the limit current, the constant current limiter operates and the output voltage drops. The output voltage further, then the foldback current circuitry operates to decrease the output current. When the output pin is short-circuited to the ground, the output current drops and maintains a flow about 30mA.

■ NOTES ON USE

1. Please use this IC within the stated absolute maximum ratings. Operation beyond these limits may cause degrading or permanent damage to the device.
2. The X8101 goes into an undefined operation when the CE pin is left open. The CE pin shall be tied to low or high level.
3. V_{OUT} pin voltage should not be applied beyond the V_{IN} pin voltage. The IC may get damage due to the reverse current toward the V_{IN} pin.

TYPICAL PERFORMANCE CHARACTERISTICS

(1) ON Resistance vs. Input Voltage

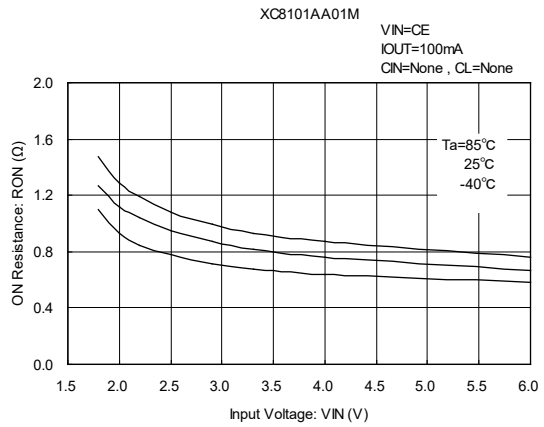
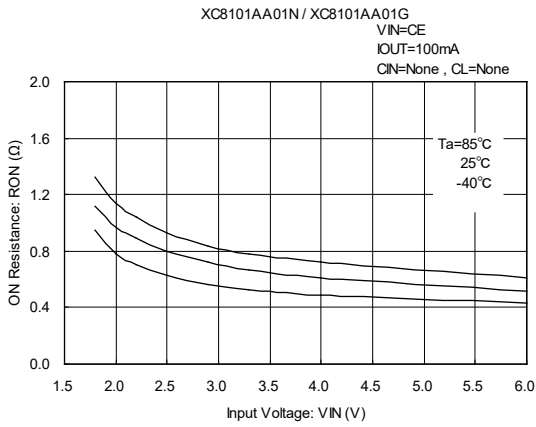

(2) ON Resistance vs. Ambient Temperature

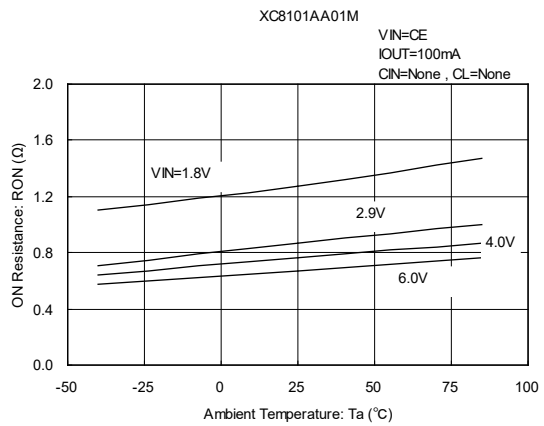
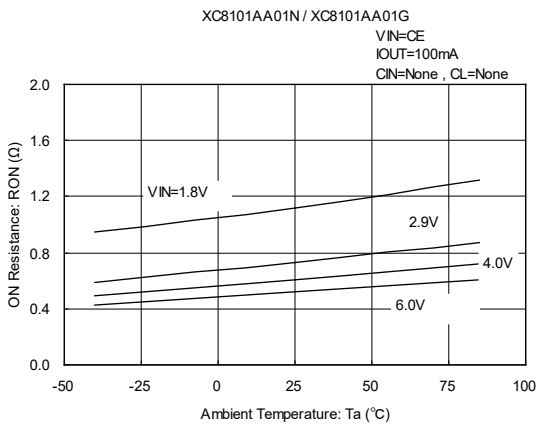

(3) Supply Current vs. Input Voltage

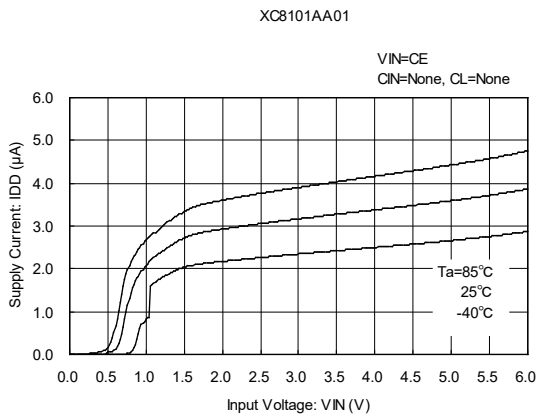

(4) Supply Current vs. Ambient Temperature

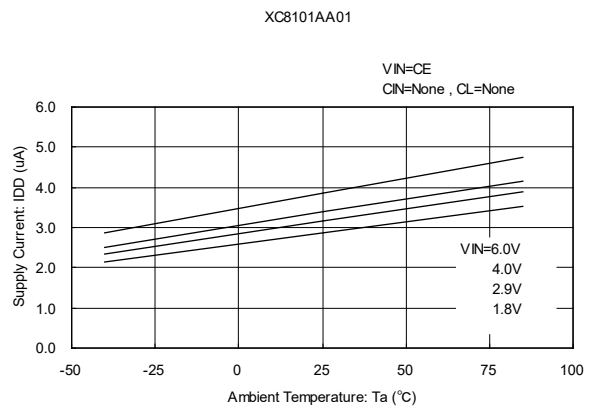

■ TYPICAL PERFORMANCE CHARACTERISTICS (Continued)

(5) Output Voltage vs. Output Current

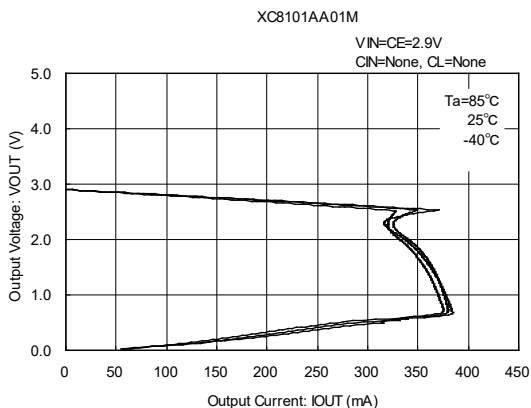
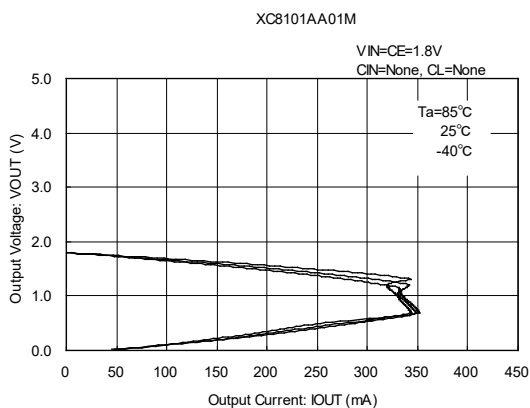
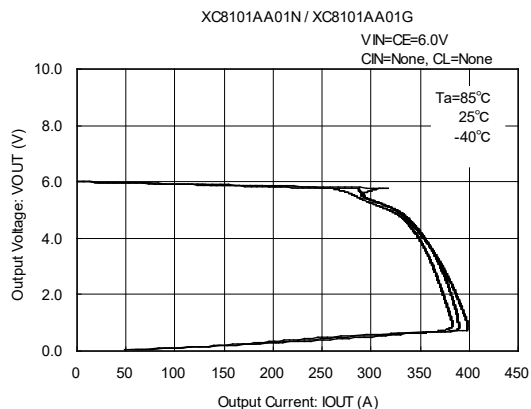
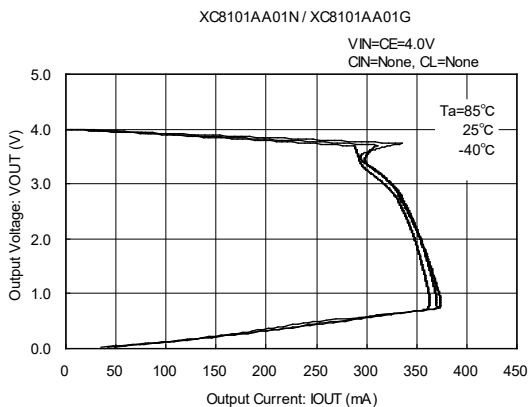
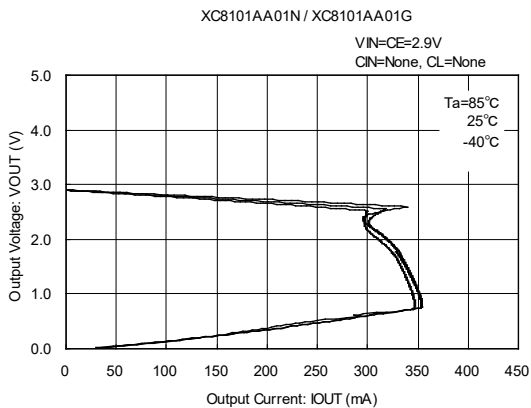
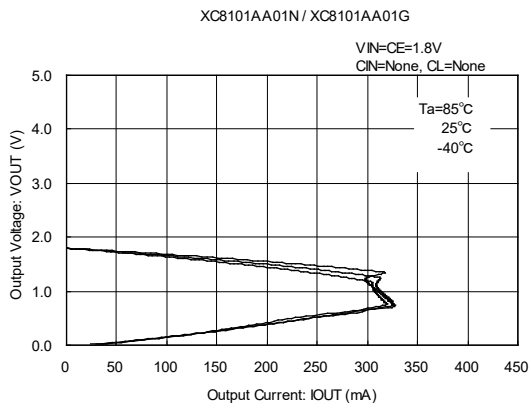

TYPICAL PERFORMANCE CHARACTERISTICS (Continued)

(5) Output Voltage vs. Output Current (Continued)

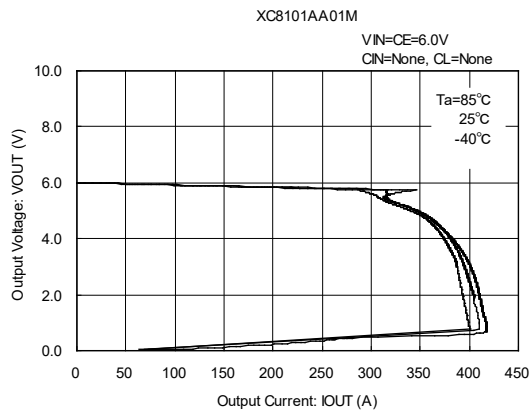
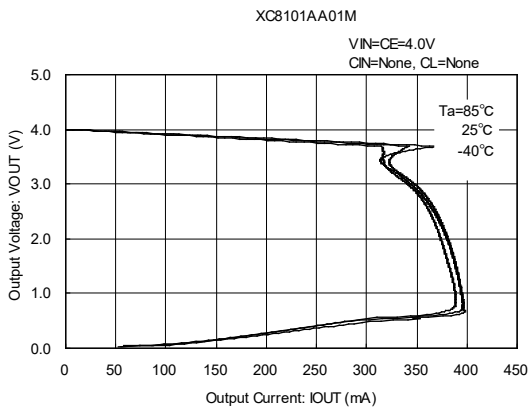

(6) CE Threshold Voltage vs. Ambient Temperature

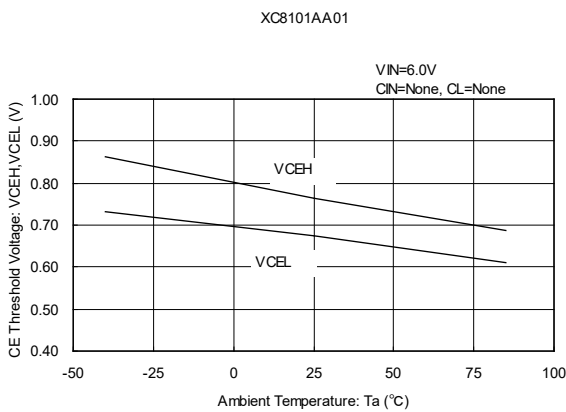

(7) CL Discharge Resistance vs. Ambient Temperature

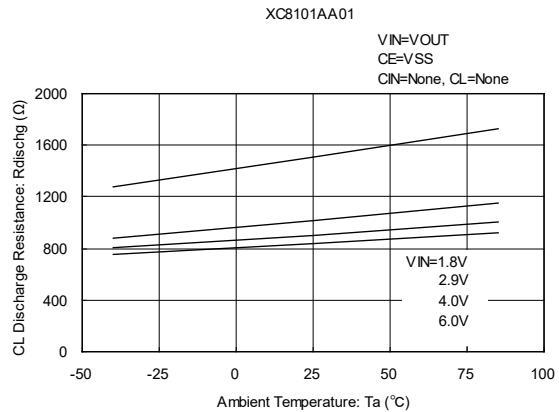

(8) Output Turn-on Time with CE

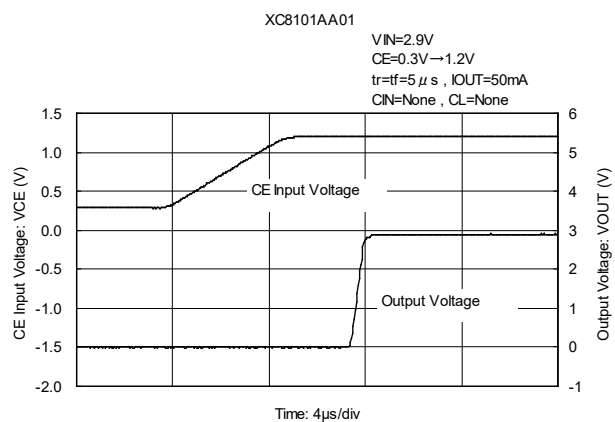
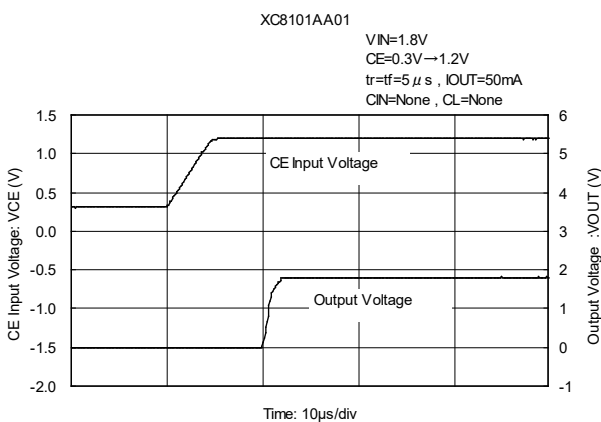

■ TYPICAL PERFORMANCE CHARACTERISTICS (Continued)

(8) Output Turn-on Time with CE (Continued)

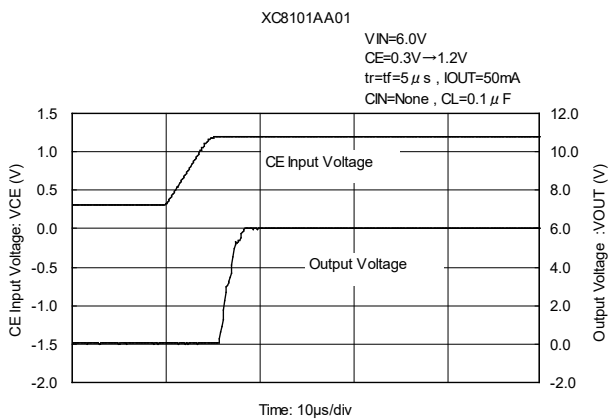
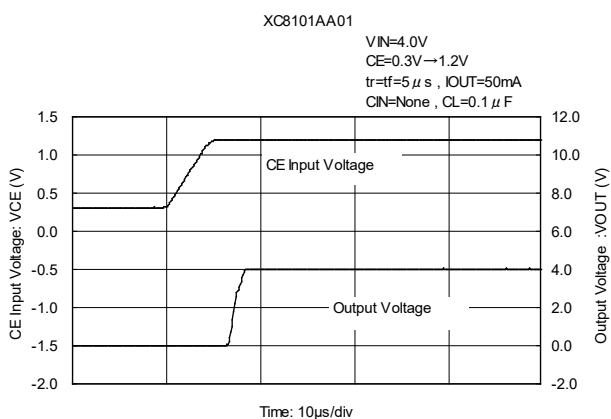
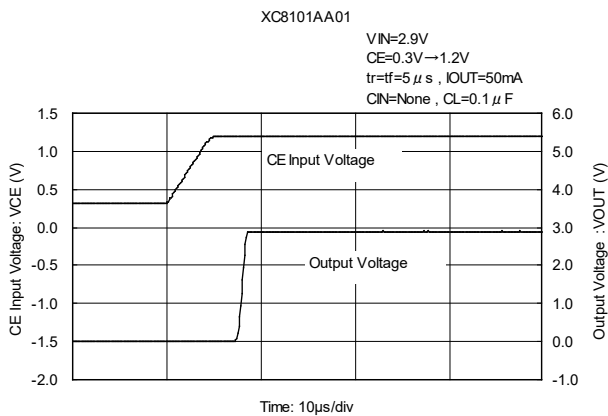
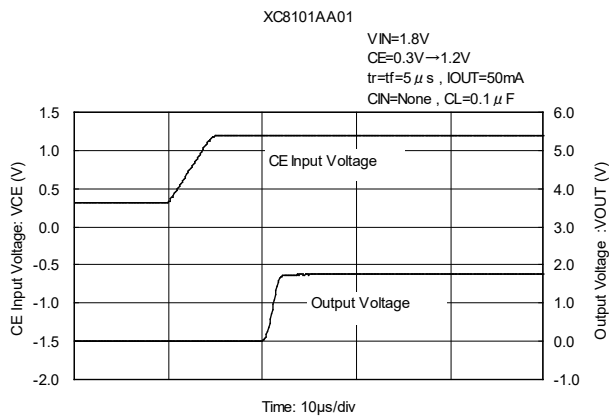
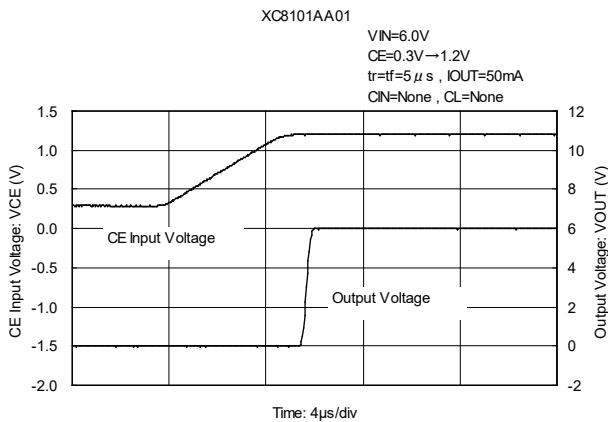
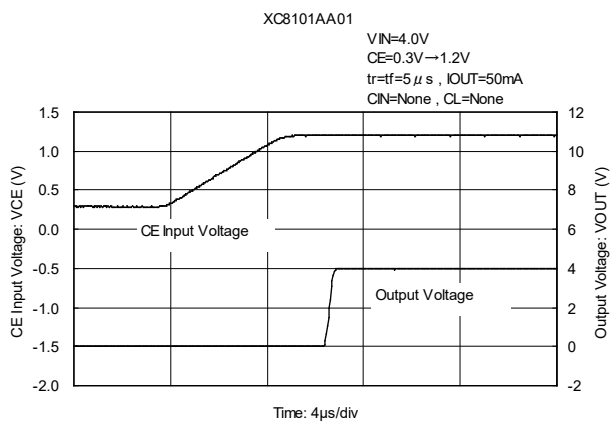

TYPICAL PERFORMANCE CHARACTERISTICS (Continued)

(8) Output Turn-on Time with CE (Continued)

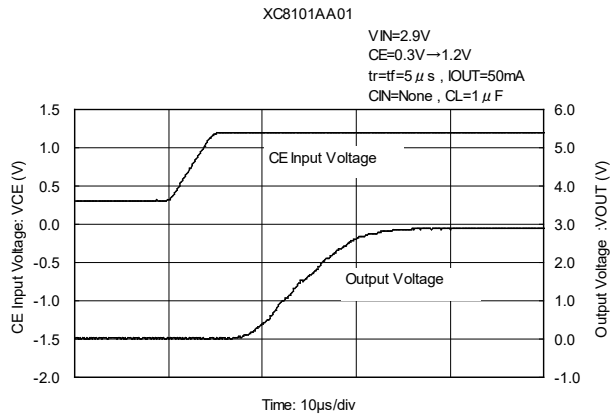
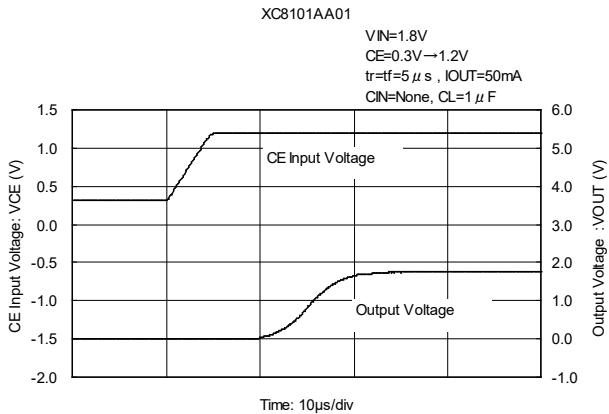
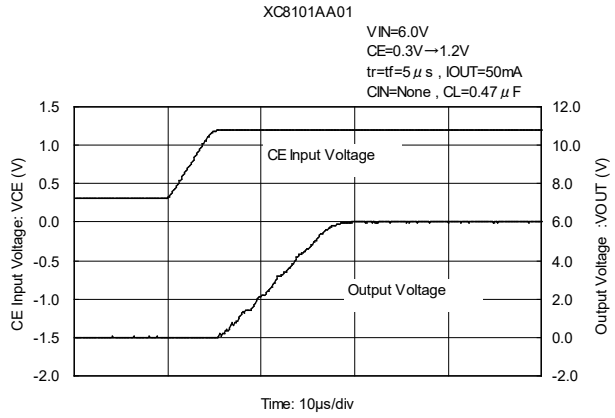
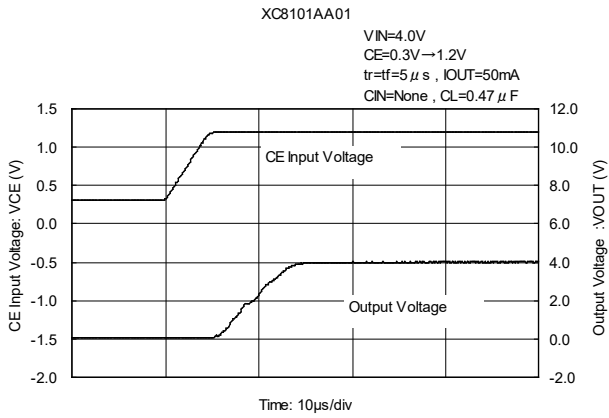
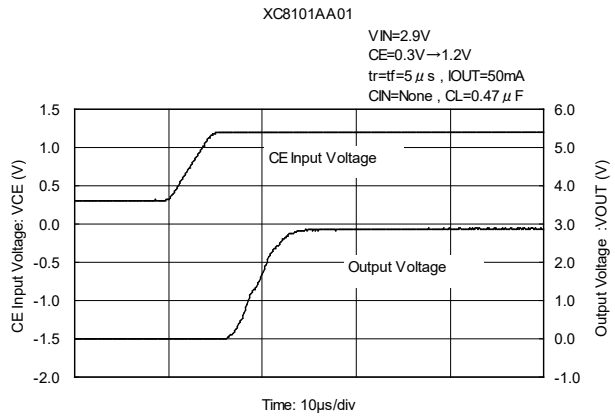
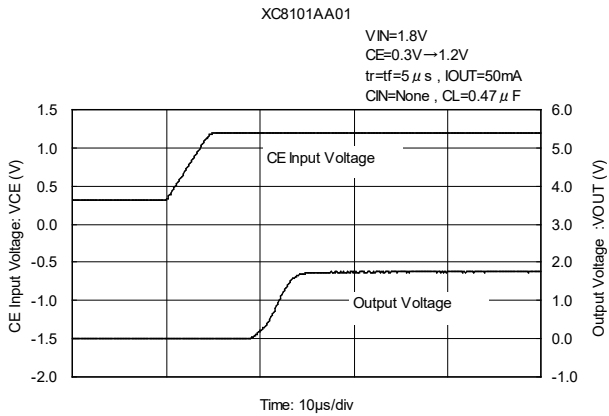

■ TYPICAL PERFORMANCE CHARACTERISTICS (Continued)

(8) Output Turn-on Time with CE (Continued)

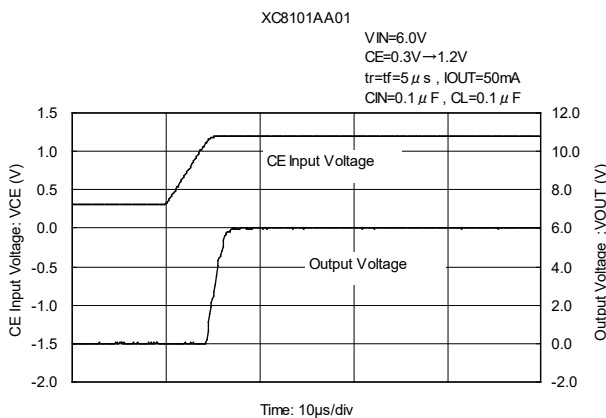
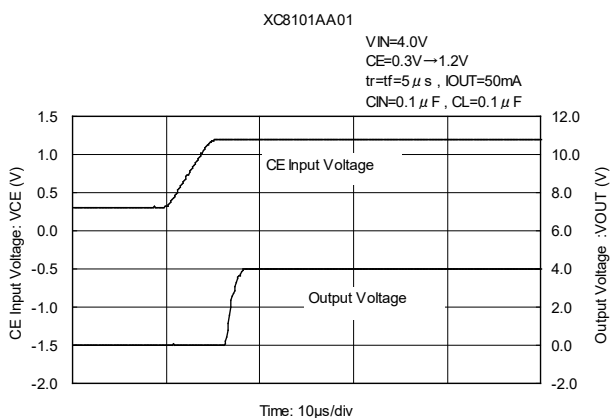
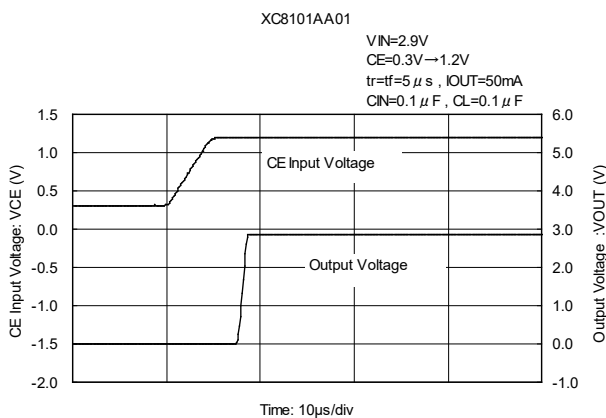
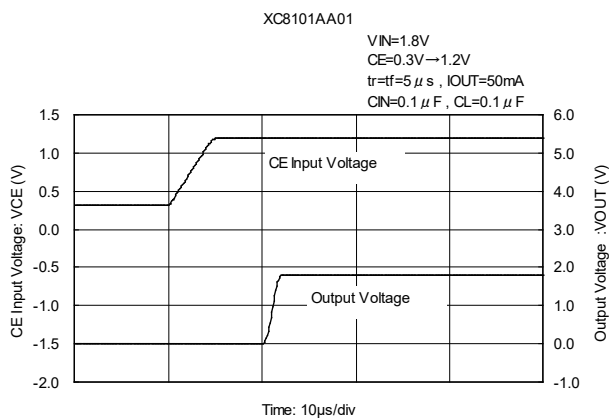
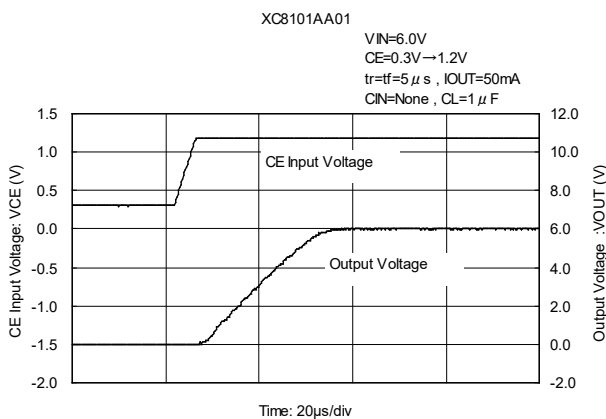
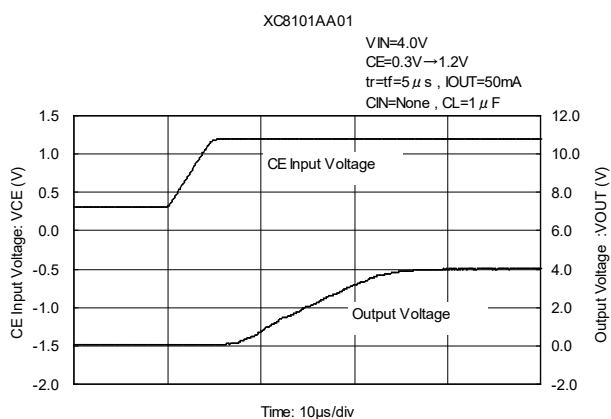

TYPICAL PERFORMANCE CHARACTERISTICS (Continued)

(8) Output Turn-on Time with CE (Continued)

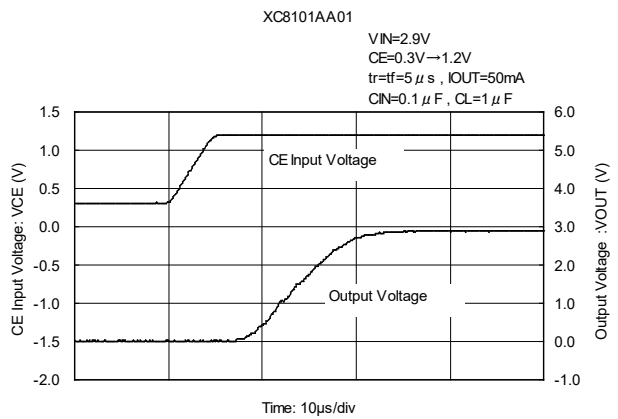
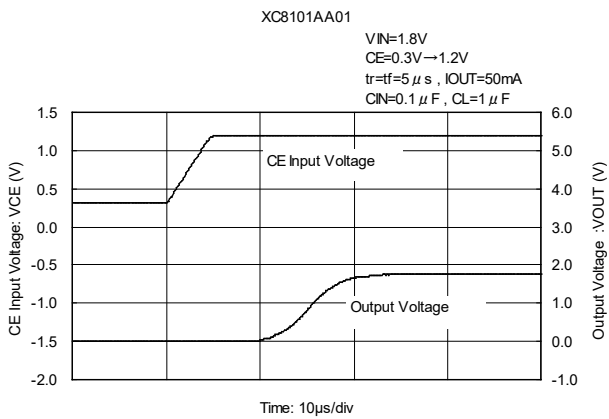
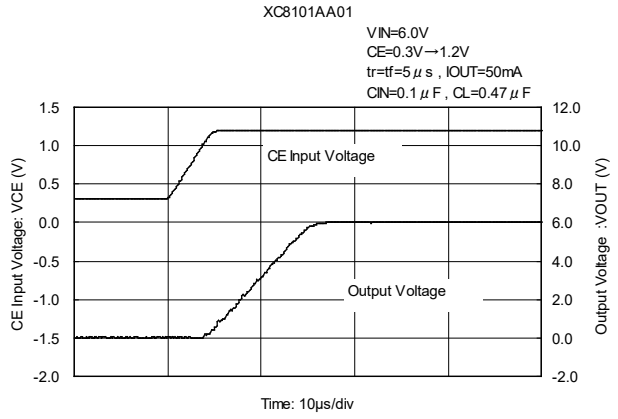
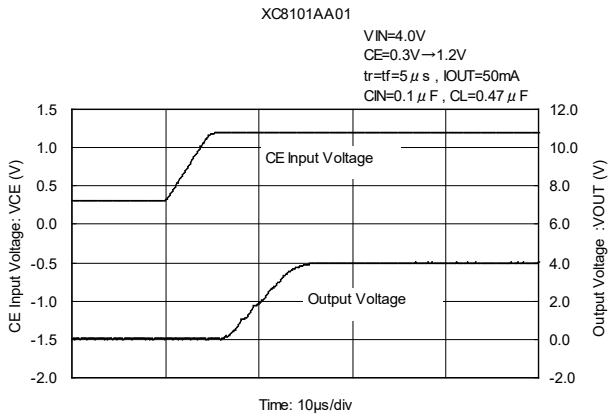
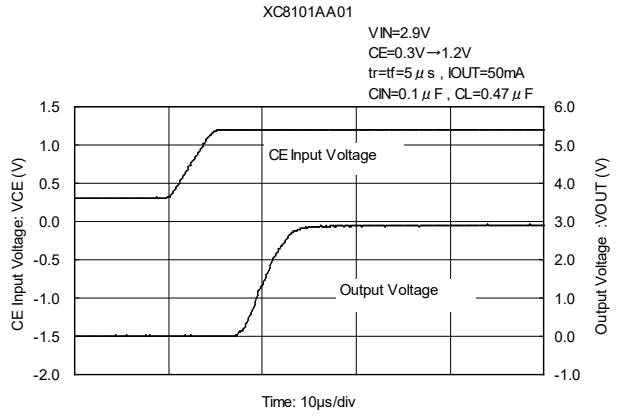
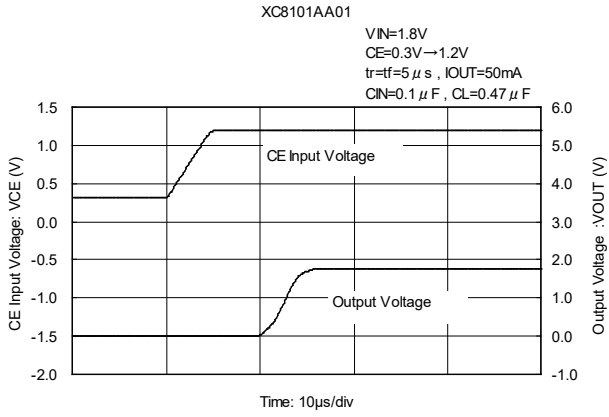

TYPICAL PERFORMANCE CHARACTERISTICS (Continued)

(8) Output Turn-on Time with CE (Continued)

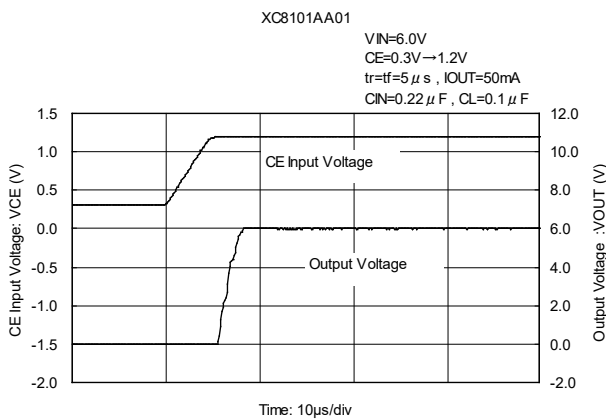
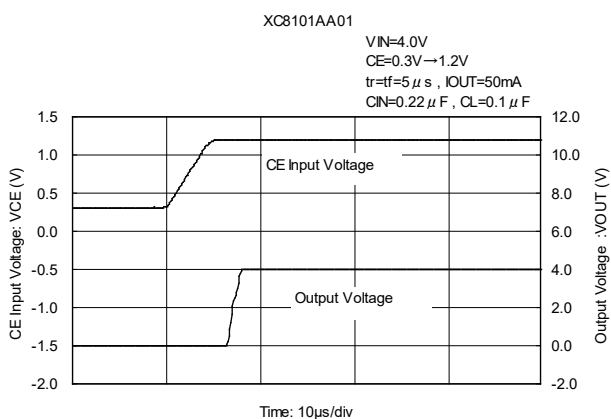
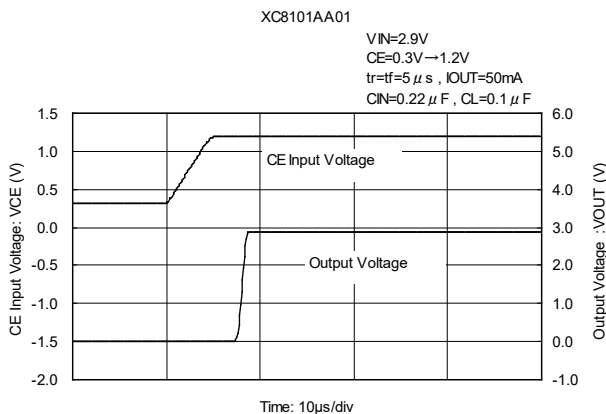
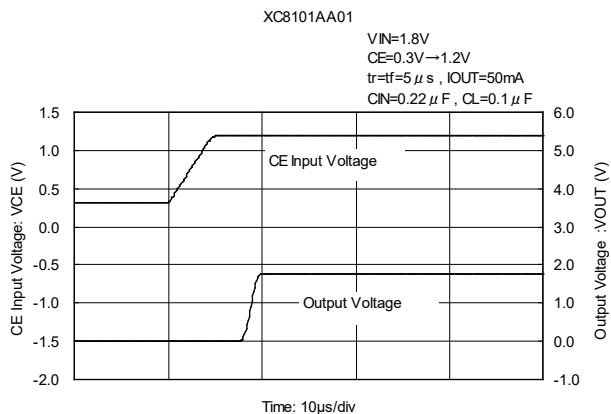
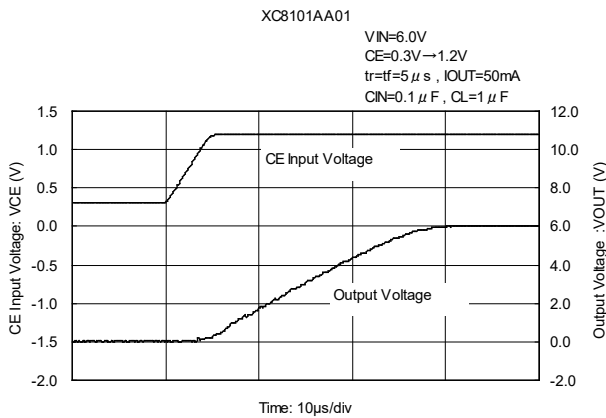
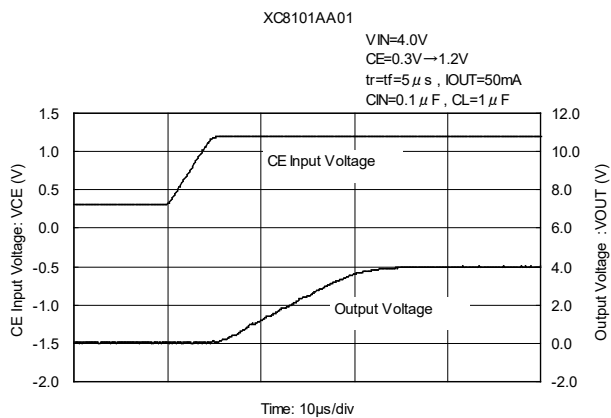

TYPICAL PERFORMANCE CHARACTERISTICS (Continued)

(8) Output Turn-on Time with CE (Continued)

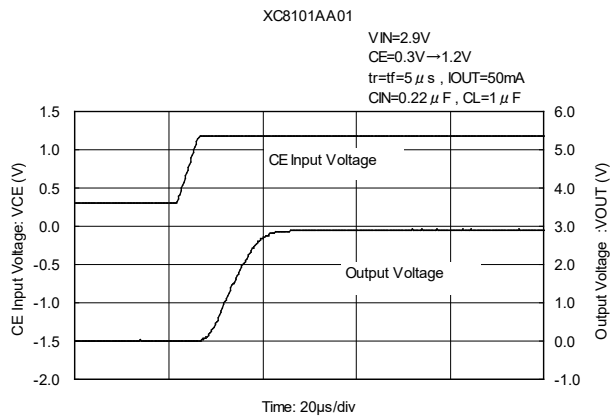
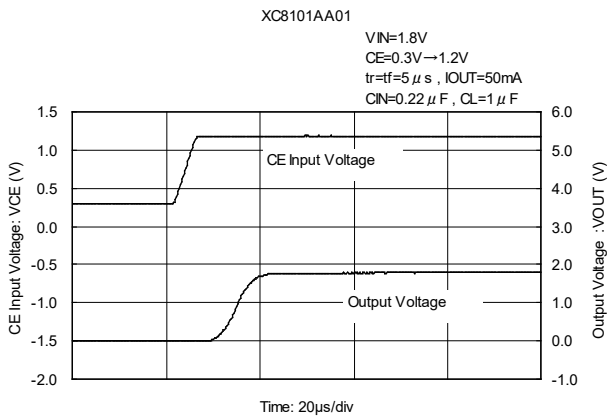
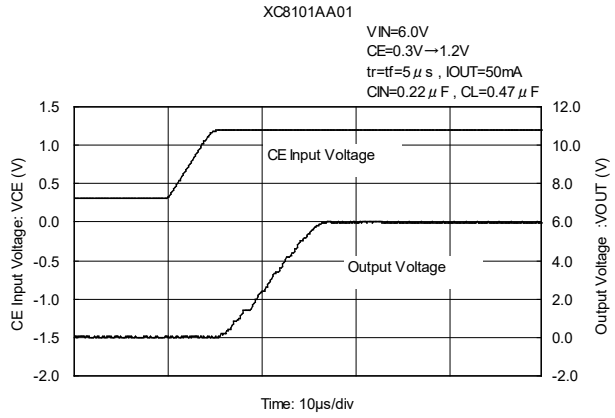
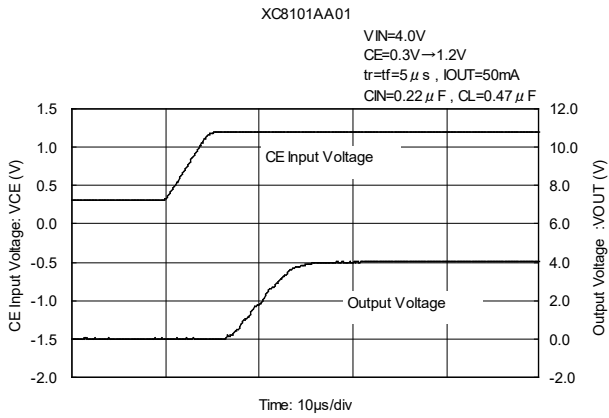
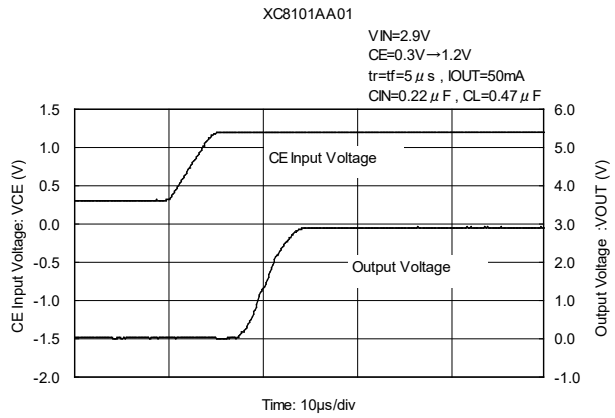
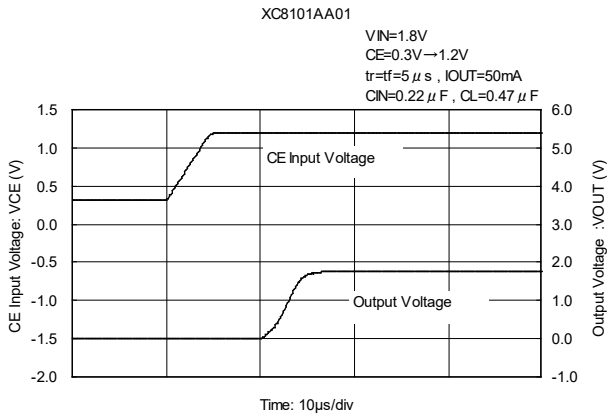

■ TYPICAL PERFORMANCE CHARACTERISTICS (Continued)

(8) Output Turn-on Time with CE (Continued)

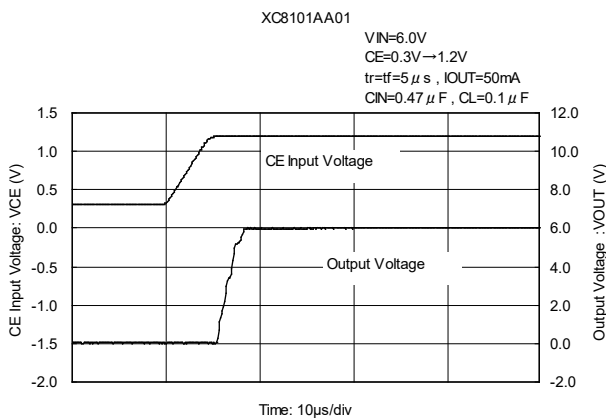
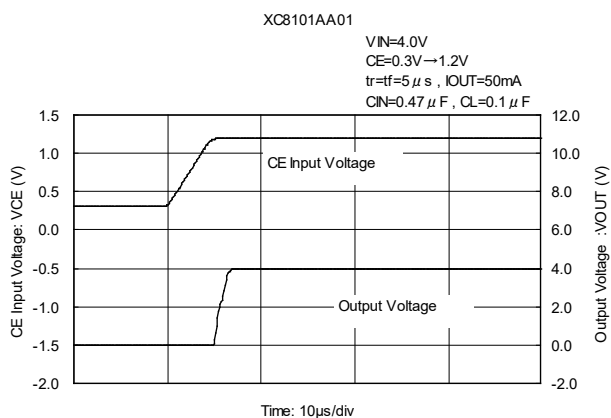
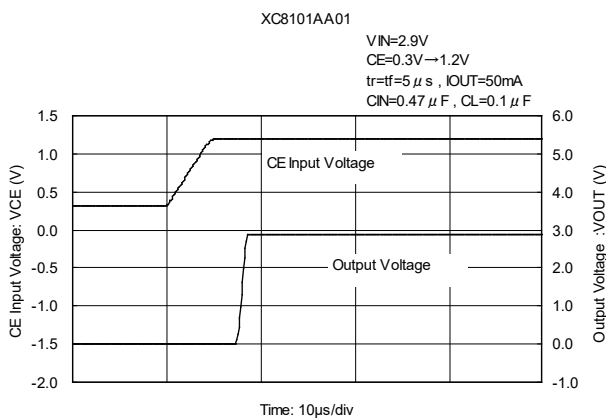
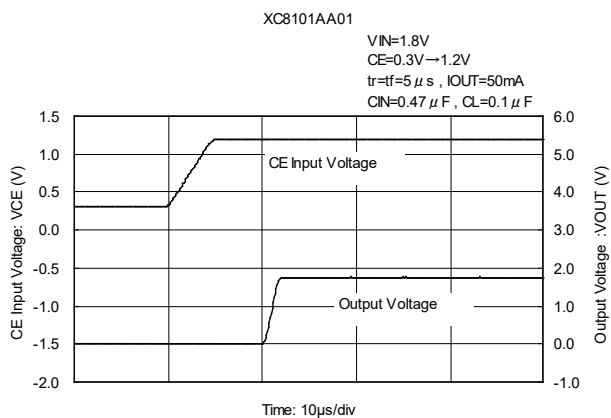
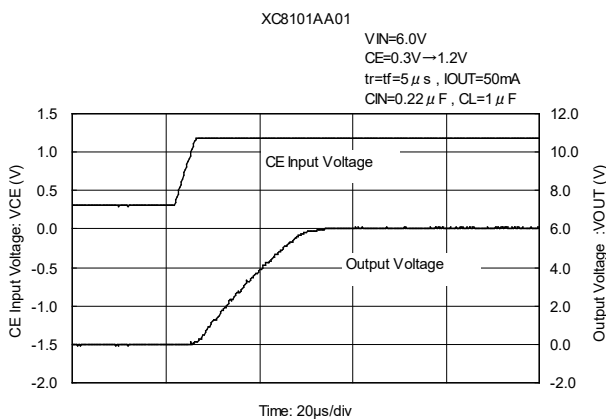
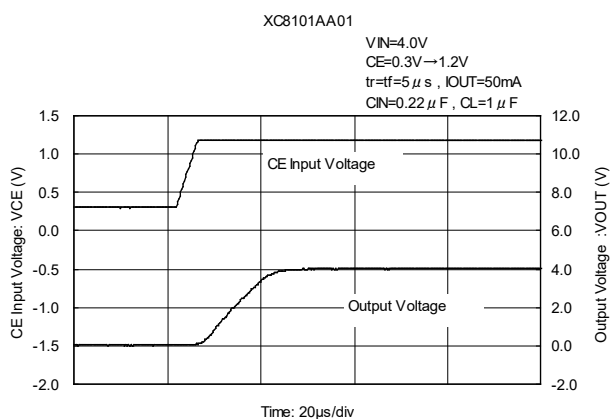

TYPICAL PERFORMANCE CHARACTERISTICS (Continued)

(8) Output Turn-on Time with CE (Continued)

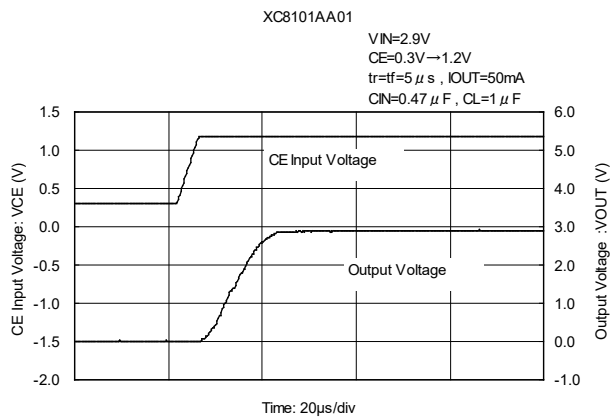
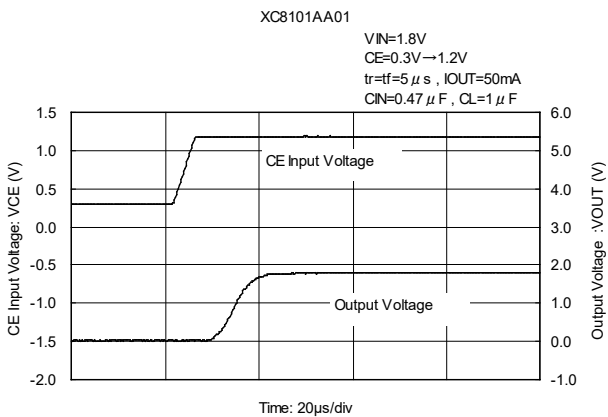
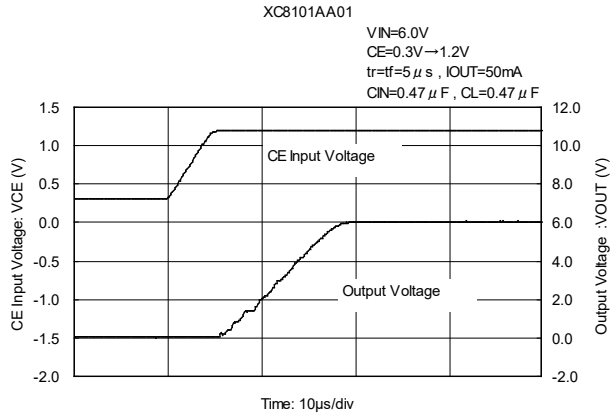
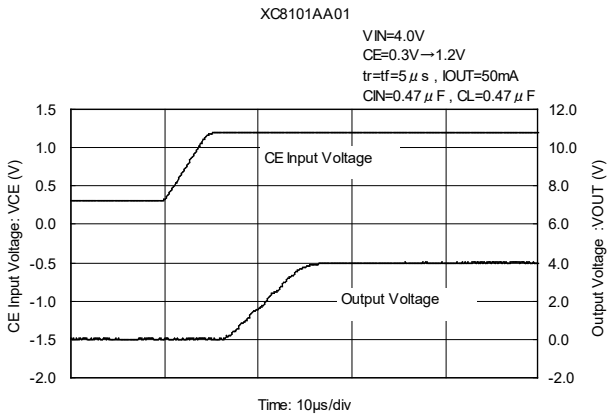
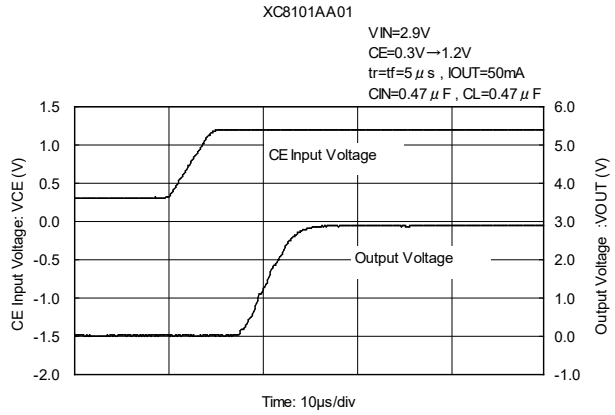
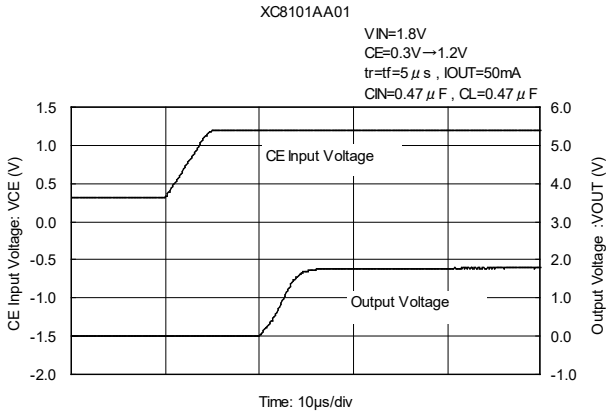

■ TYPICAL PERFORMANCE CHARACTERISTICS (Continued)

(8) Output Turn-on Time with CE (Continued)

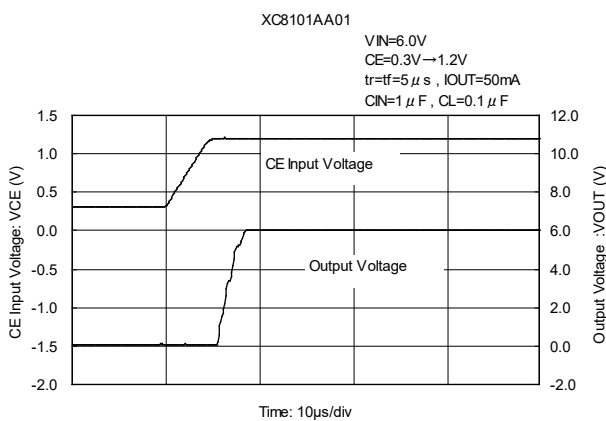
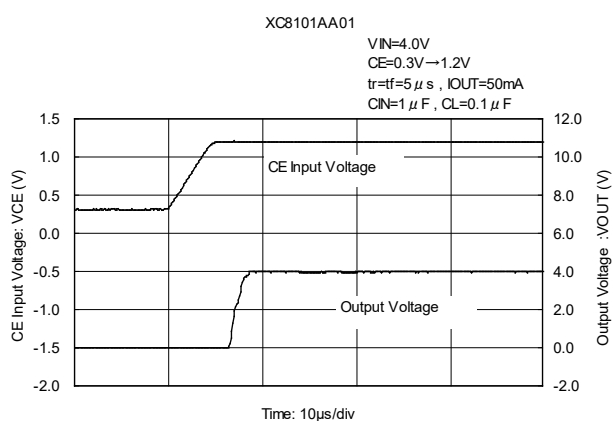
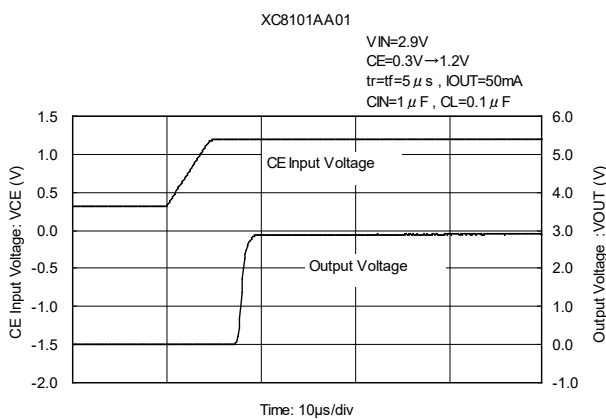
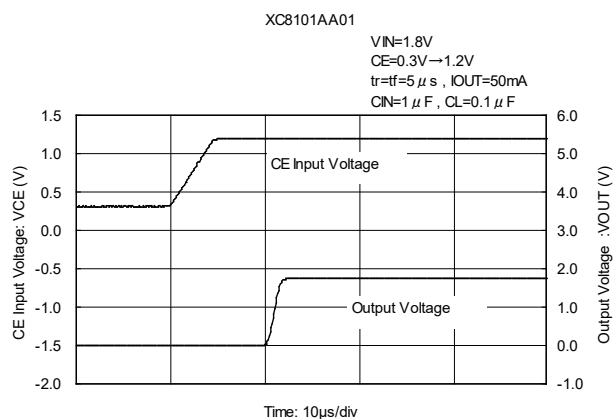
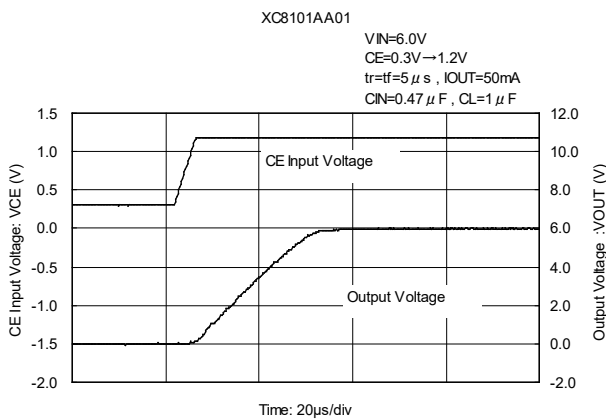
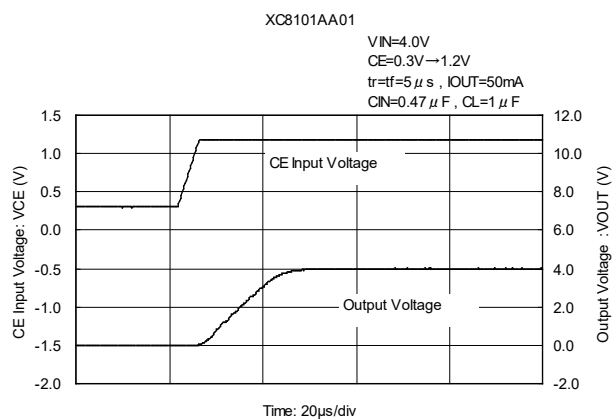

TYPICAL PERFORMANCE CHARACTERISTICS (Continued)

(8) Output Turn-on Time with CE (Continued)

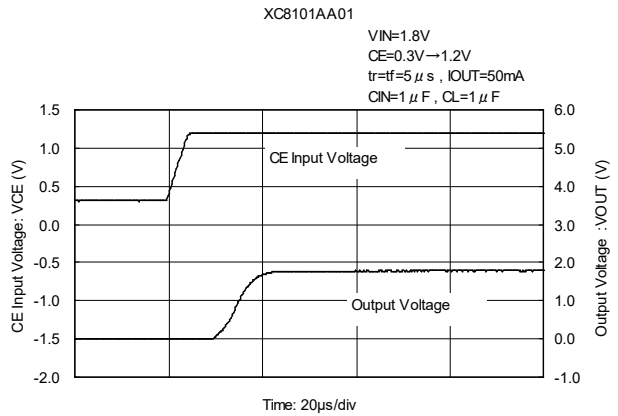
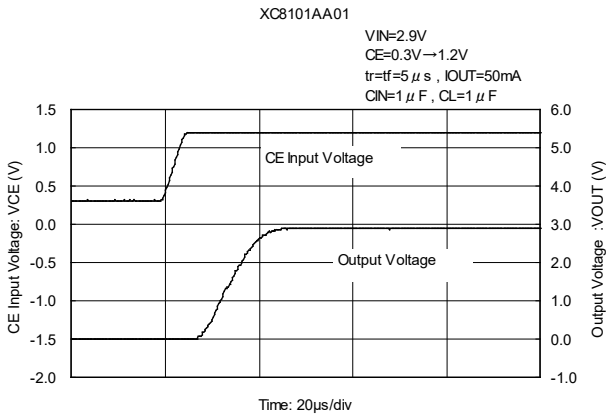
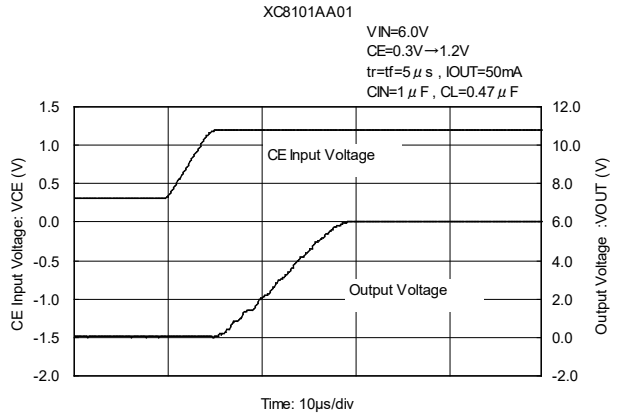
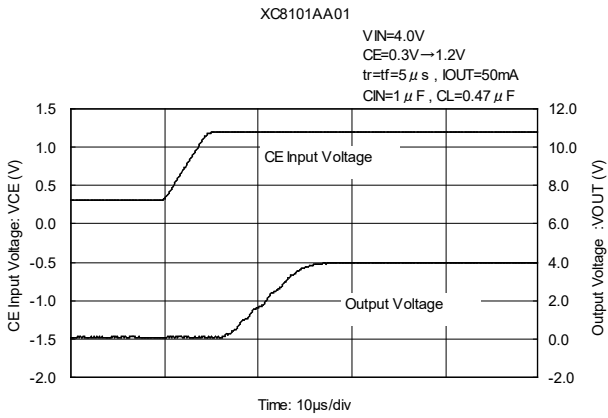
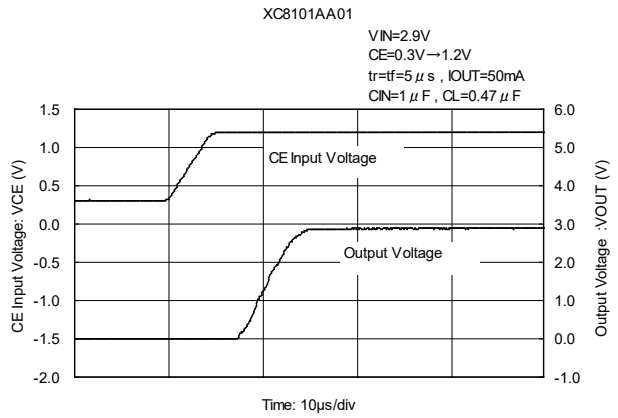
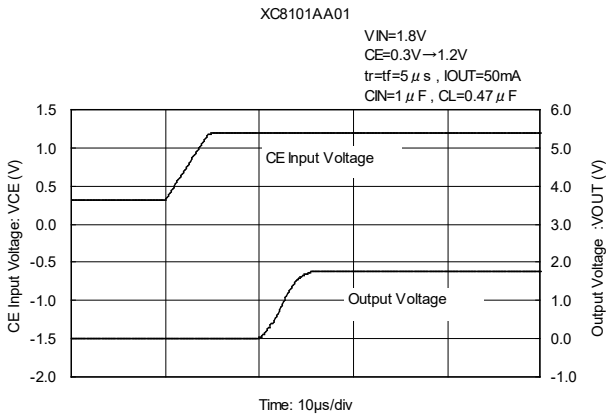

TYPICAL PERFORMANCE CHARACTERISTICS (Continued)

(8) Output Turn-on Time with CE (Continued)

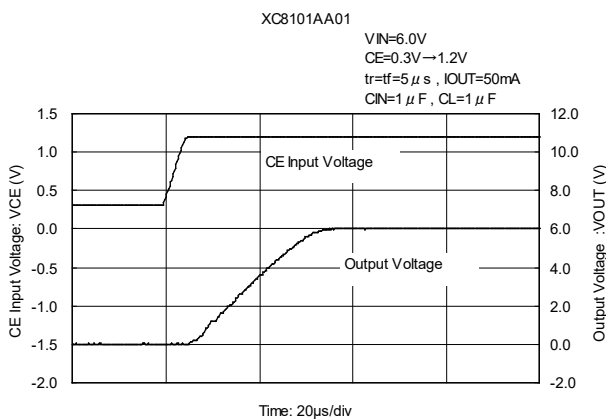
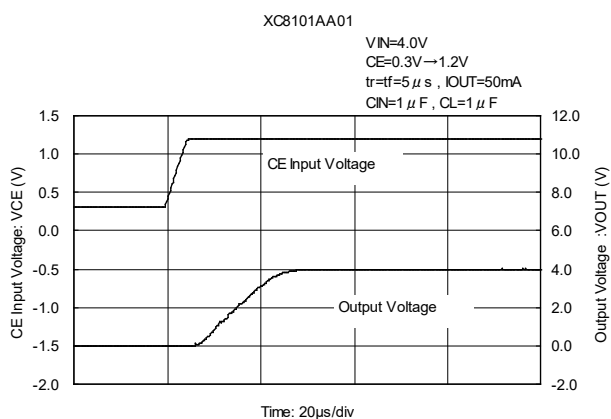

(9) Output Turn-off Time with CE

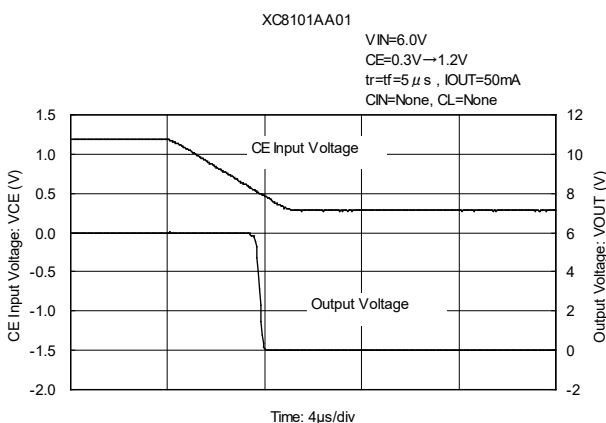
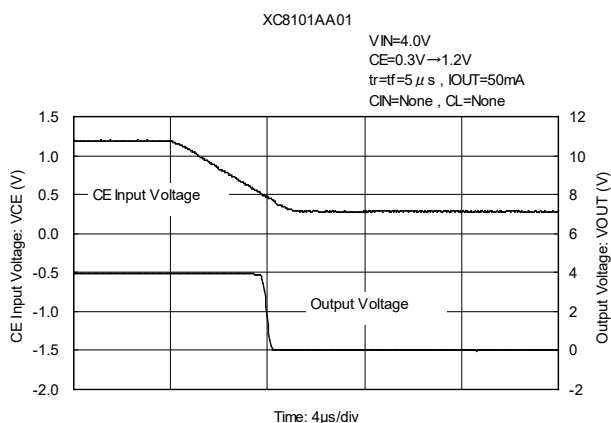
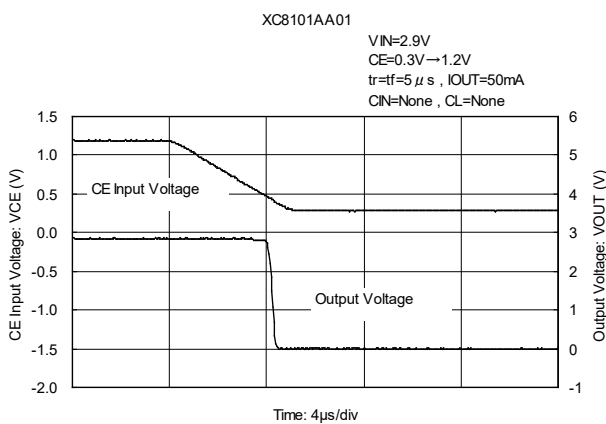
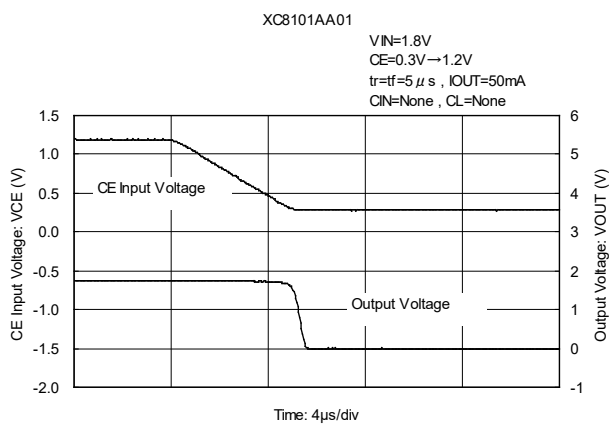

TYPICAL PERFORMANCE CHARACTERISTICS (Continued)

(9) Output Turn-off Time with CE (Continued)

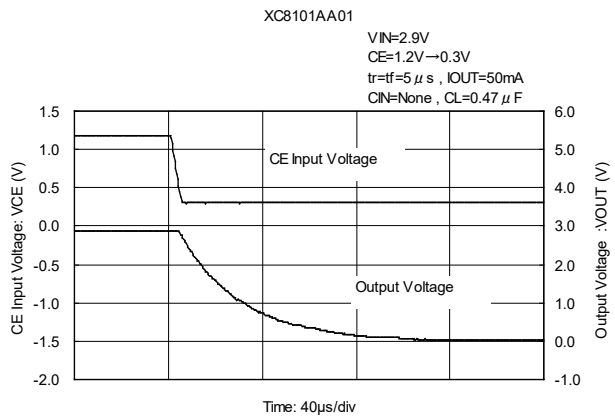
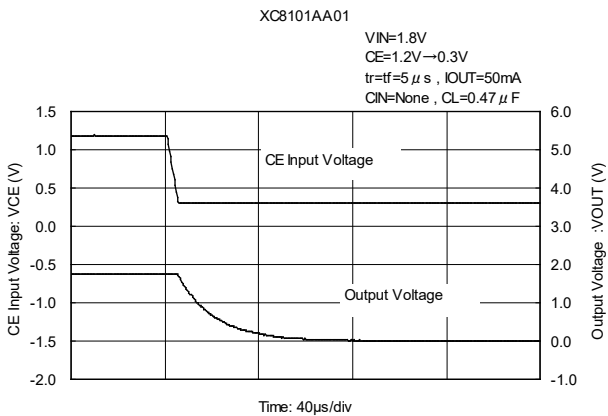
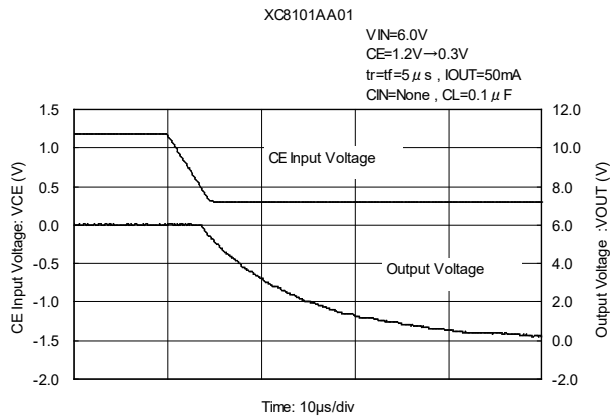
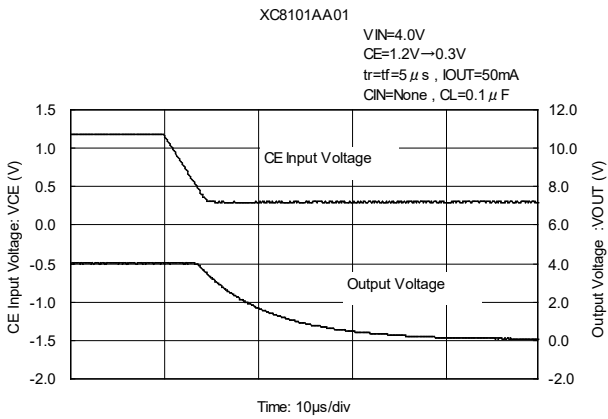
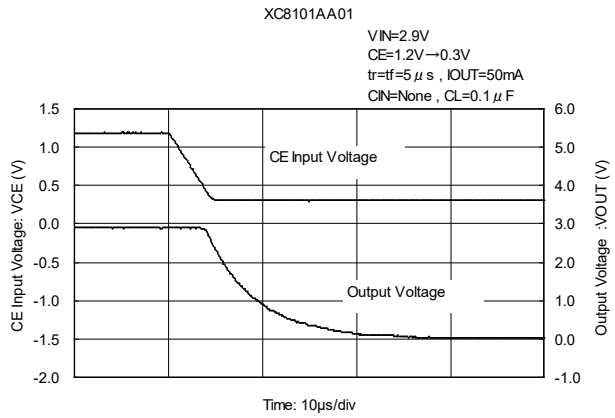
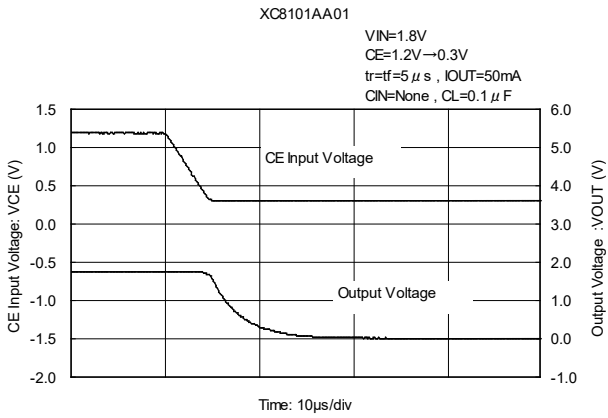

TYPICAL PERFORMANCE CHARACTERISTICS (Continued)

(9) Output Turn-off Time with CE (Continued)

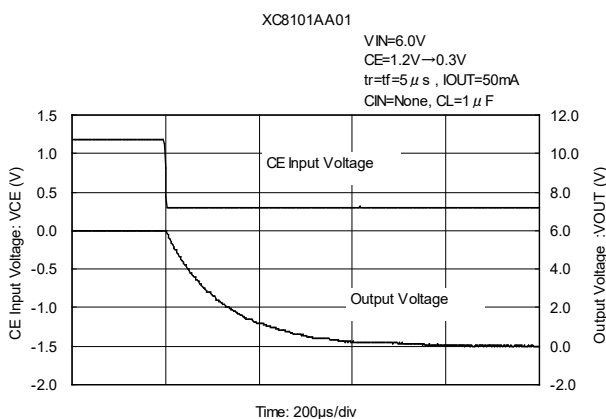
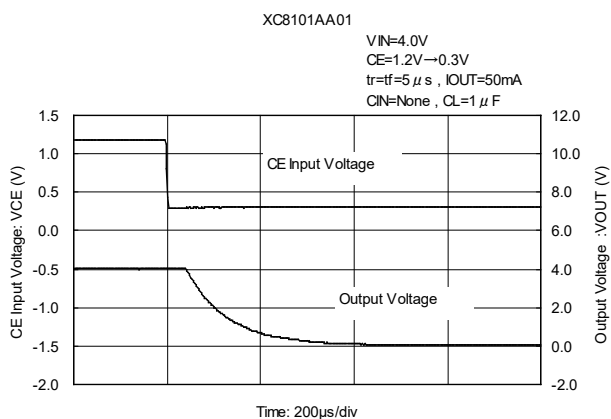
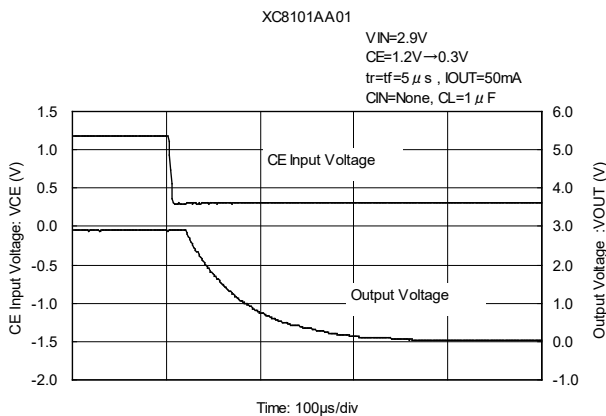
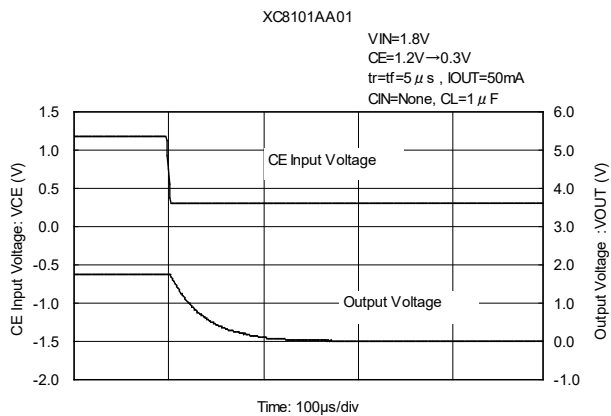
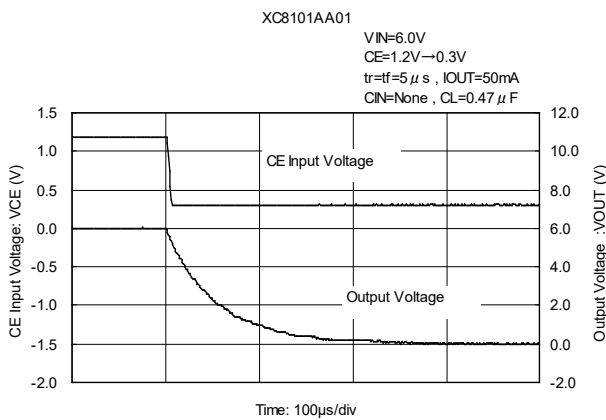
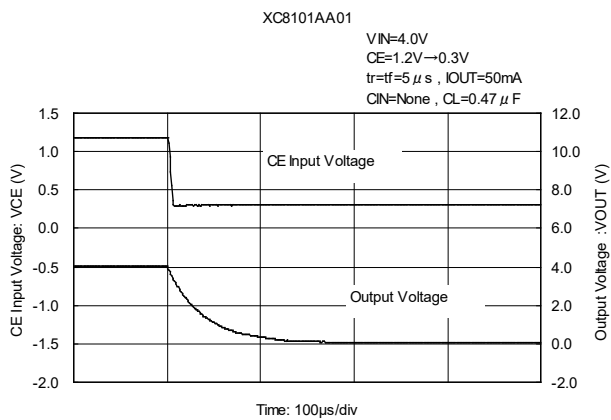

TYPICAL PERFORMANCE CHARACTERISTICS (Continued)

(9) Output Turn-off Time with CE (Continued)

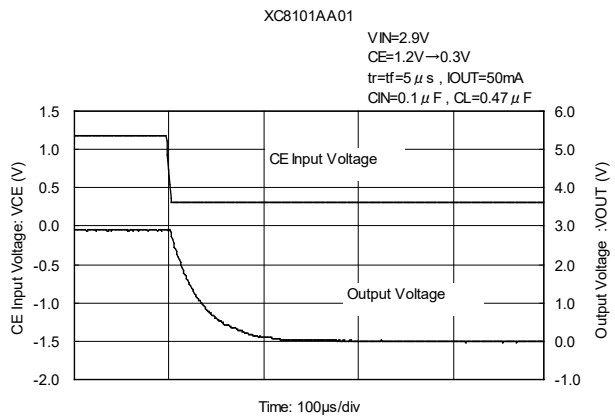
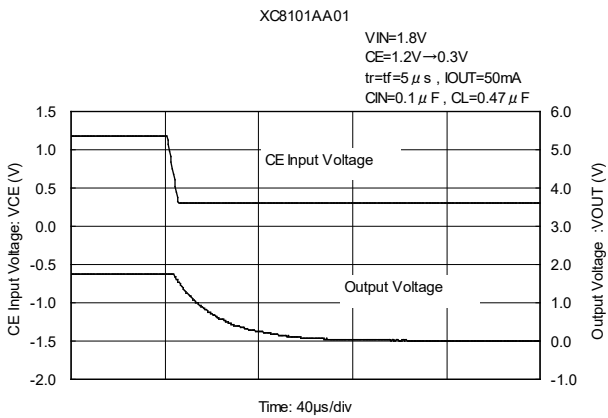
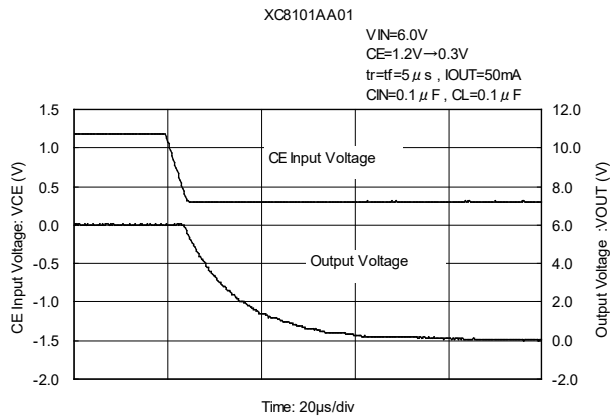
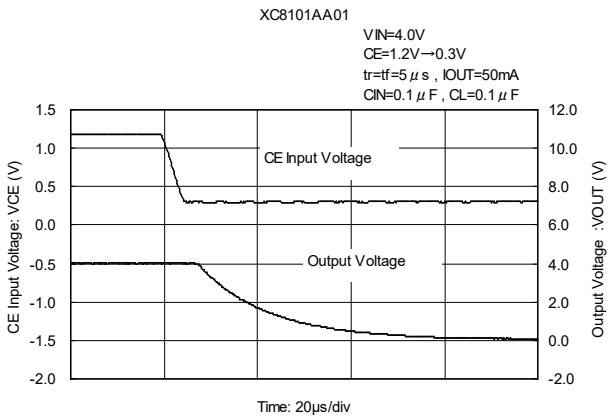
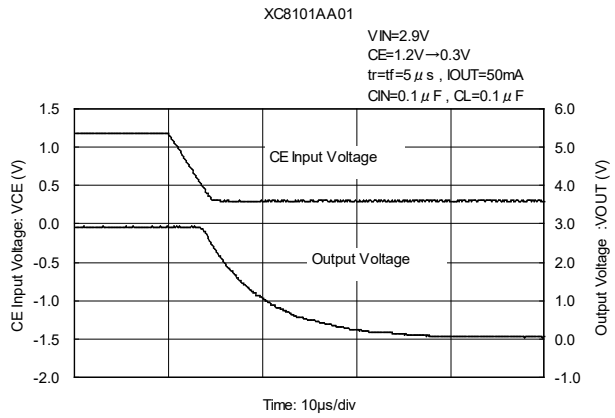
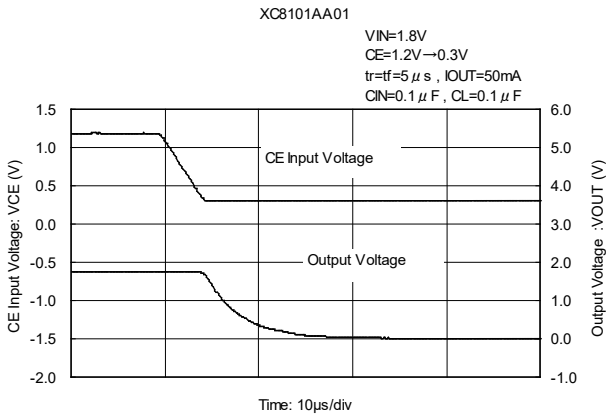

TYPICAL PERFORMANCE CHARACTERISTICS (Continued)

(9) Output Turn-off Time with CE (Continued)

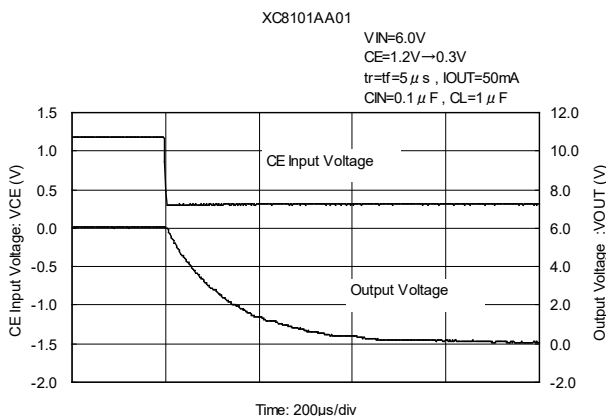
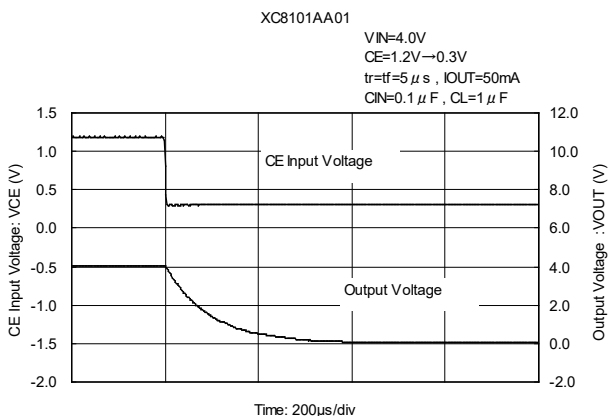
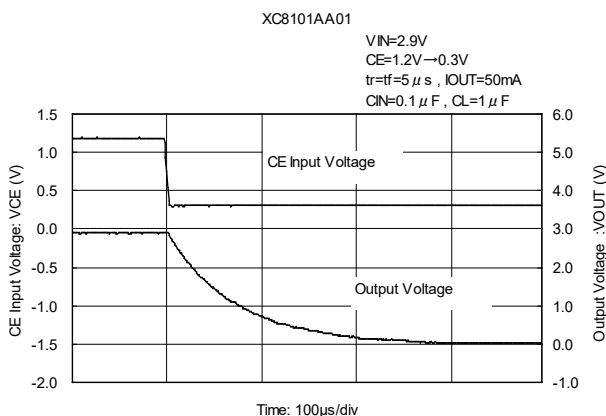
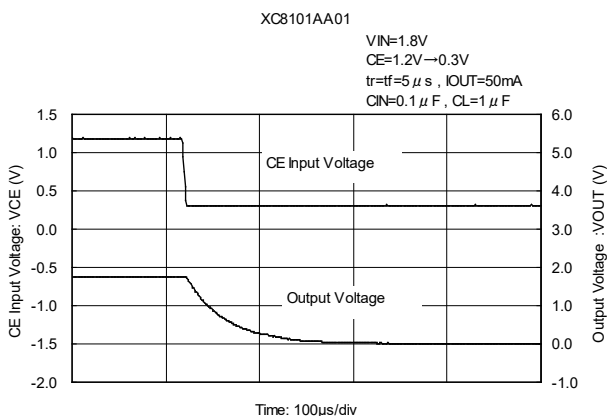
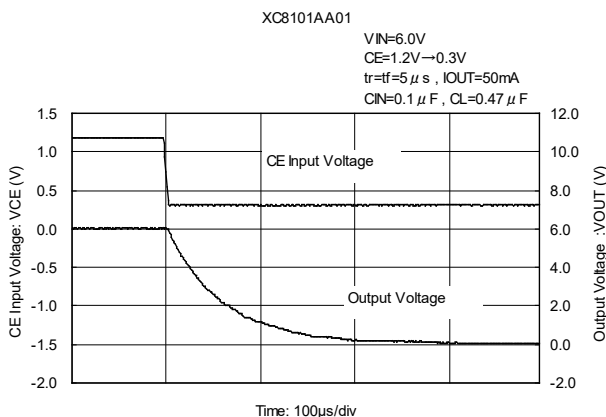
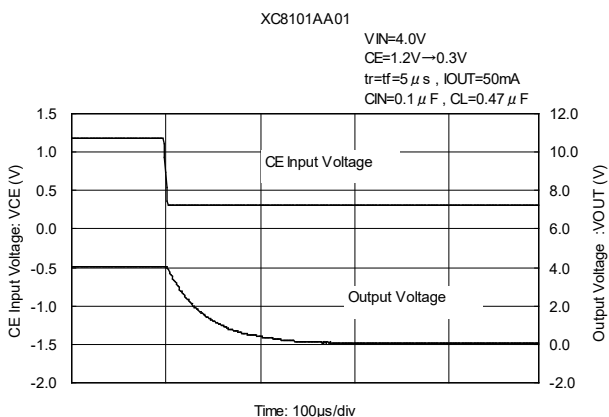

TYPICAL PERFORMANCE CHARACTERISTICS (Continued)

(9) Output Turn-off Time with CE (Continued)

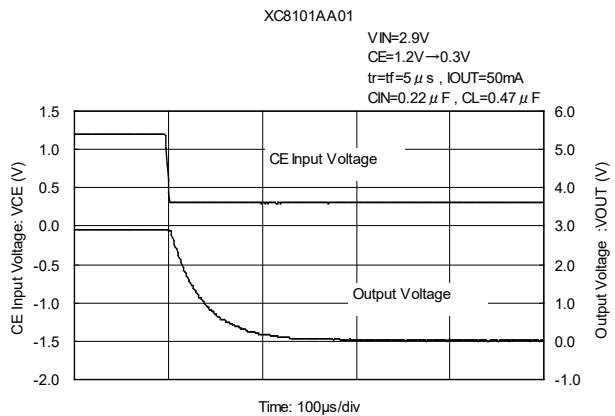
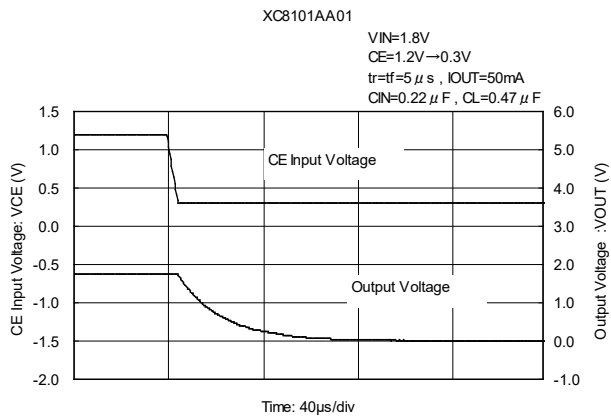
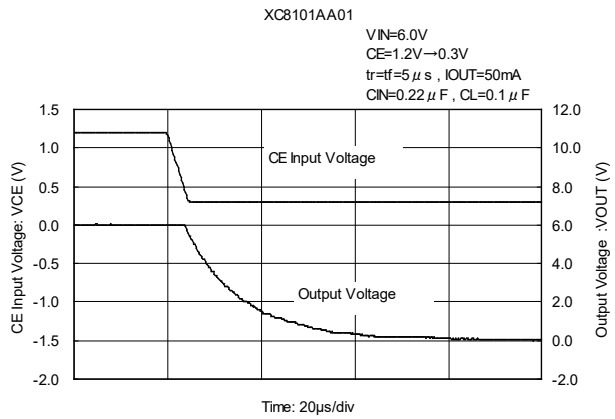
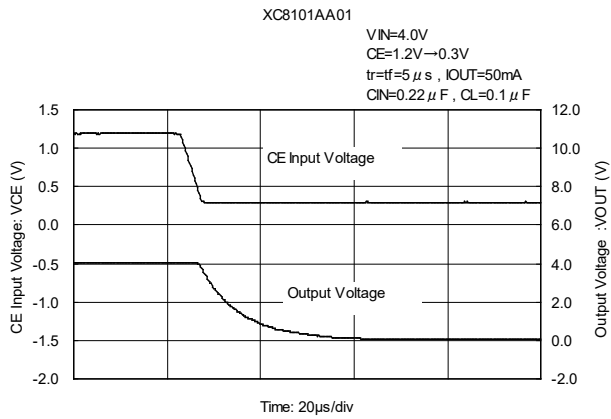
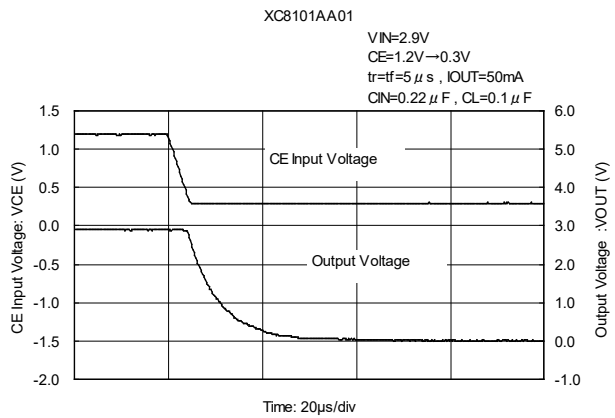
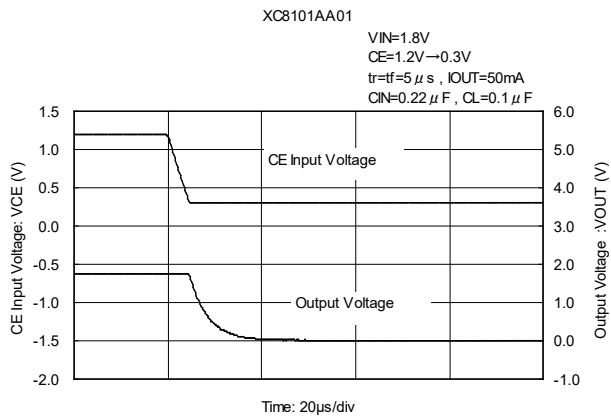

TYPICAL PERFORMANCE CHARACTERISTICS (Continued)

(9) Output Turn-off Time with CE (Continued)

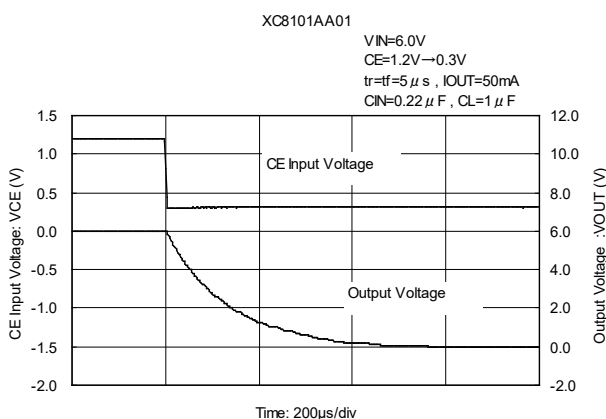
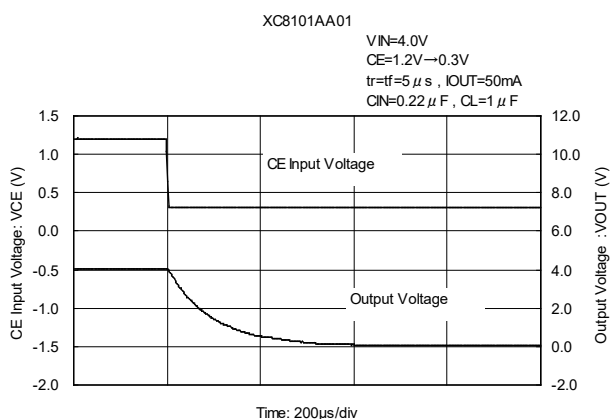
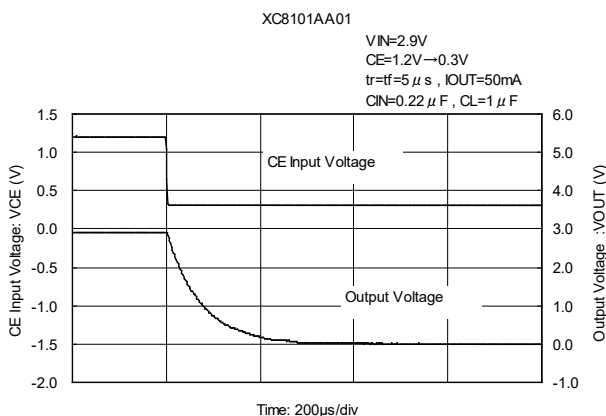
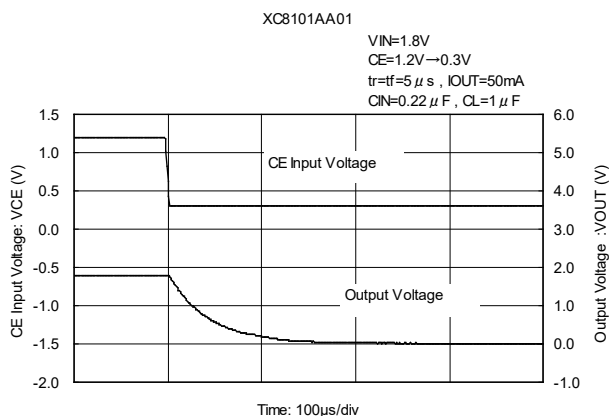
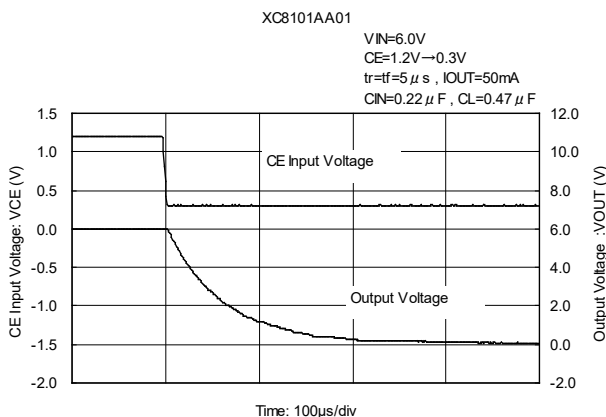
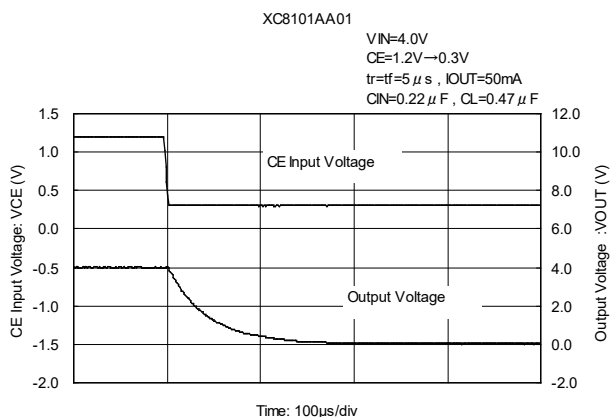

TYPICAL PERFORMANCE CHARACTERISTICS (Continued)

(9) Output Turn-off Time with CE (Continued)

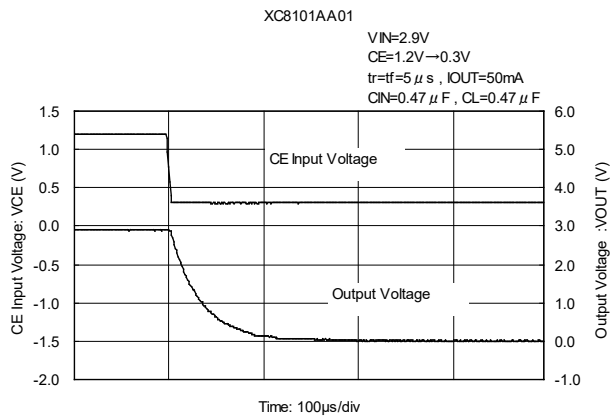
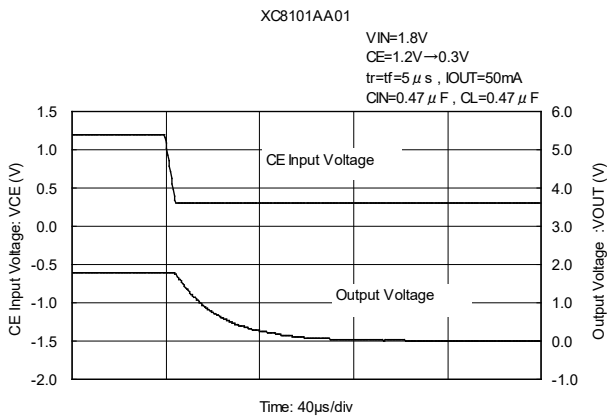
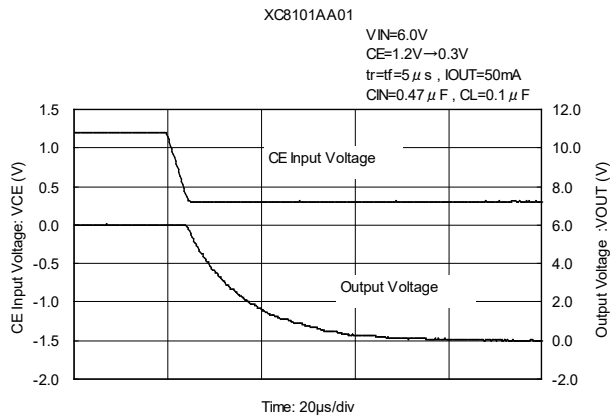
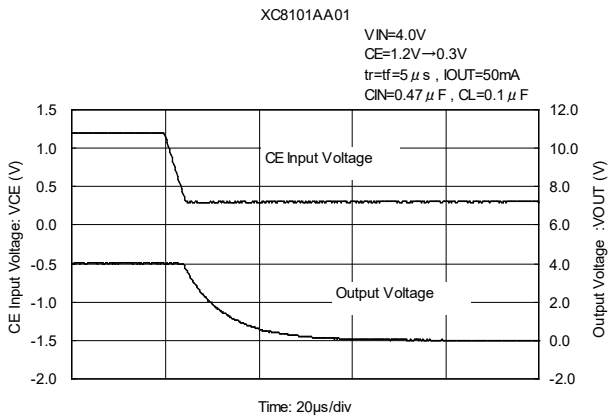
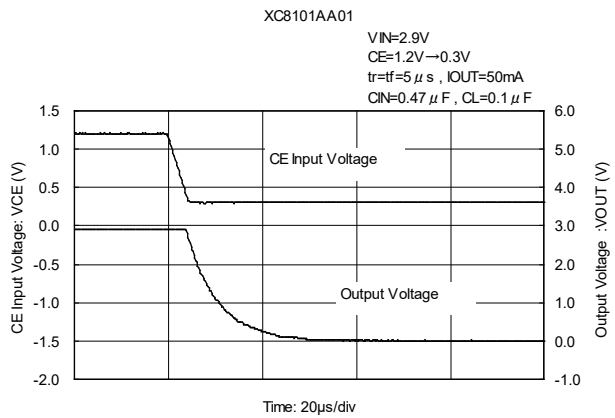
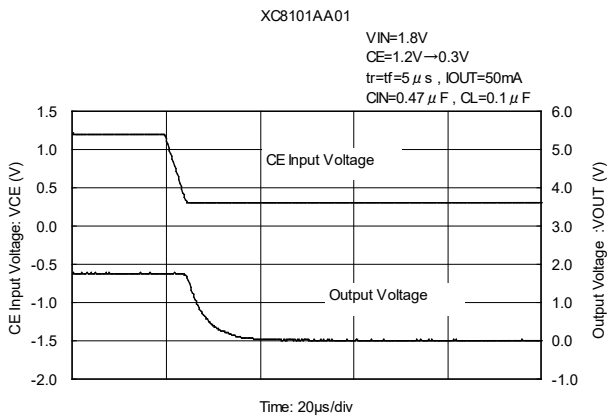

TYPICAL PERFORMANCE CHARACTERISTICS (Continued)

(9) Output Turn-off Time with CE (Continued)

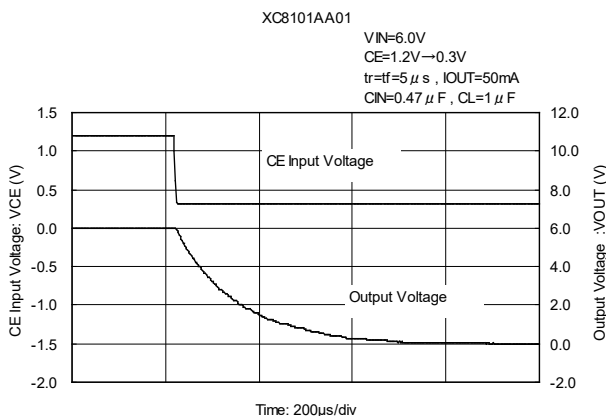
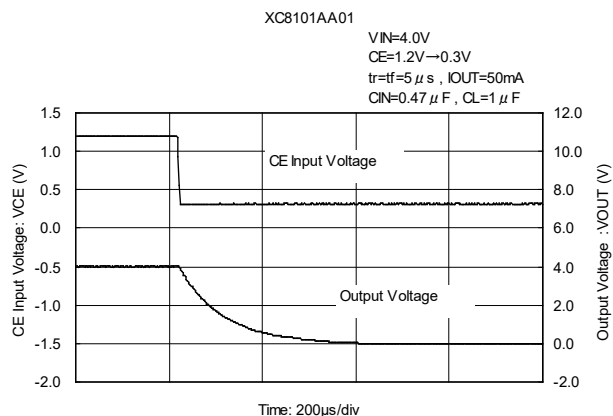
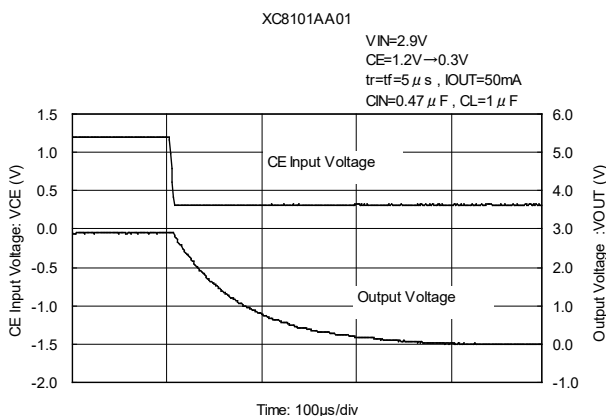
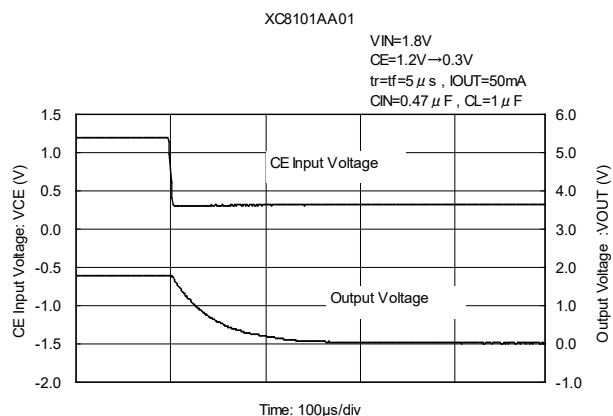
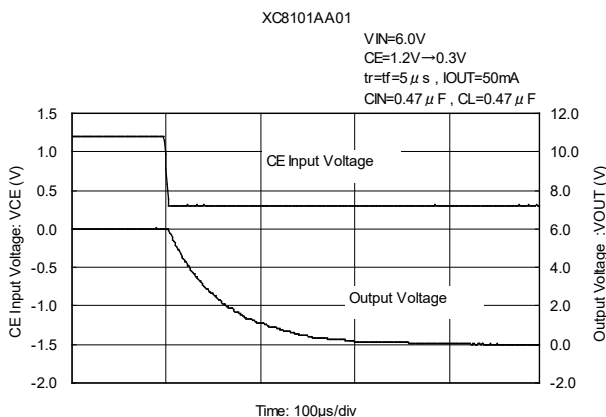
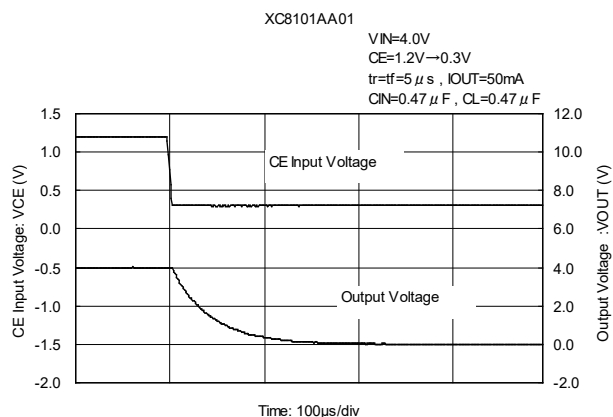

TYPICAL PERFORMANCE CHARACTERISTICS (Continued)

(9) Output Turn-off Time with CE (Continued)

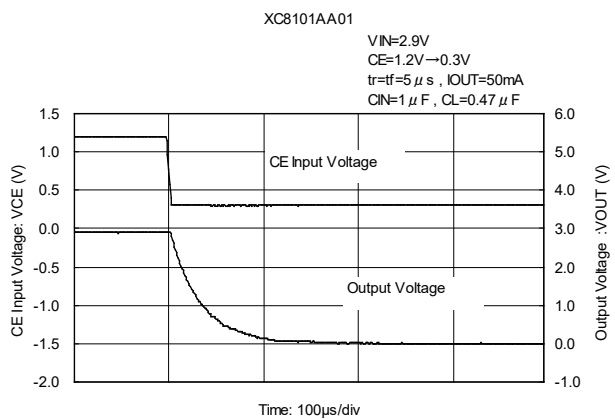
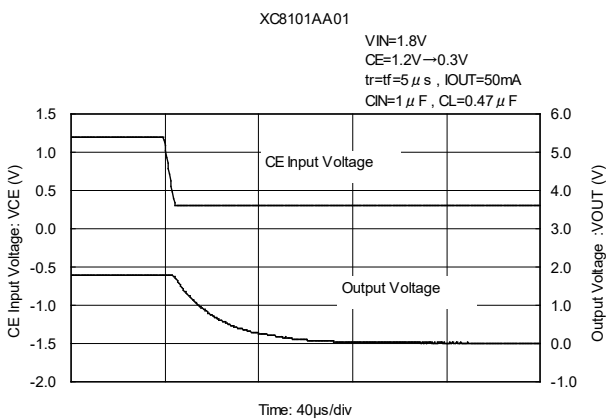
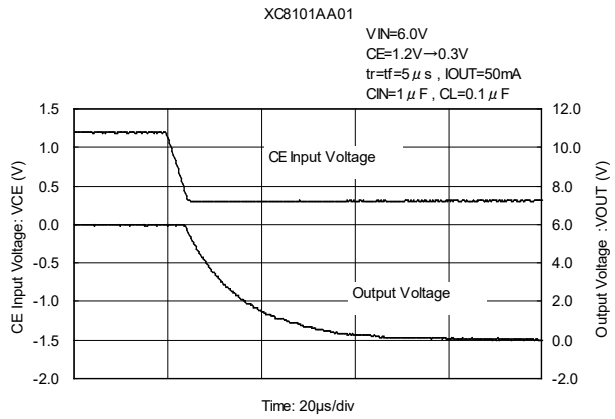
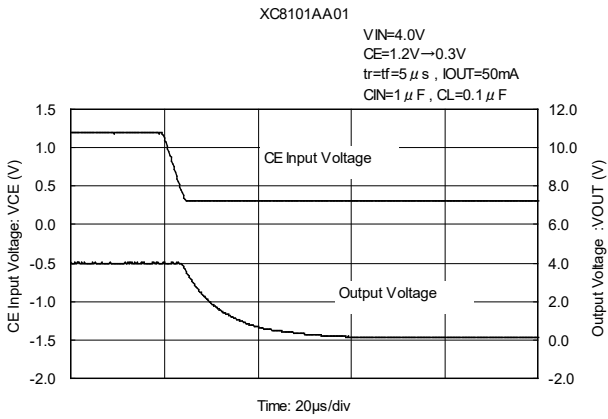
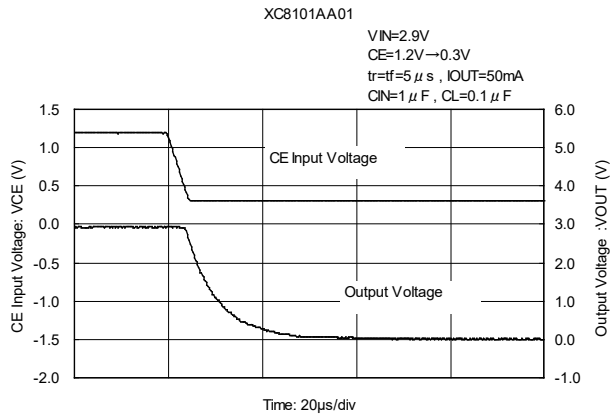
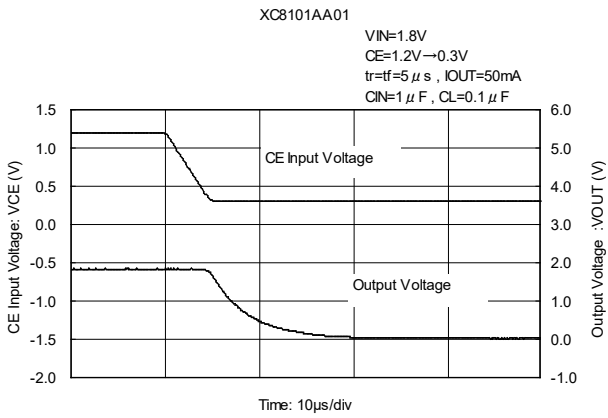

TYPICAL PERFORMANCE CHARACTERISTICS (Continued)

(9) Output Turn-off Time with CE (Continued)

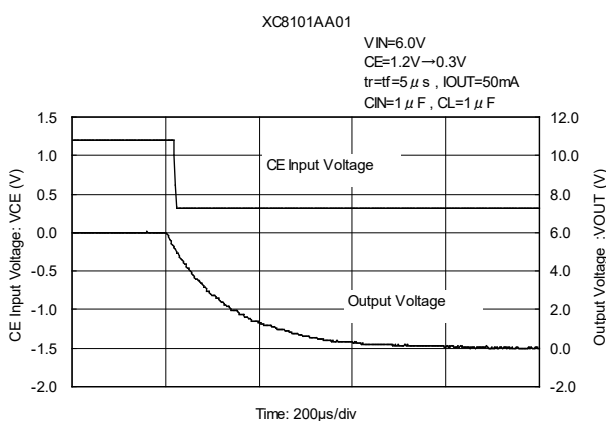
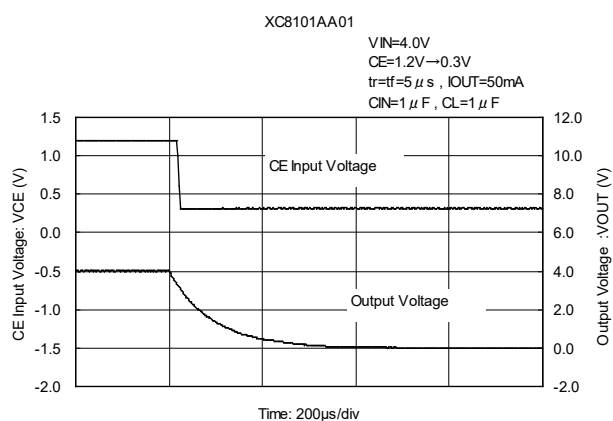
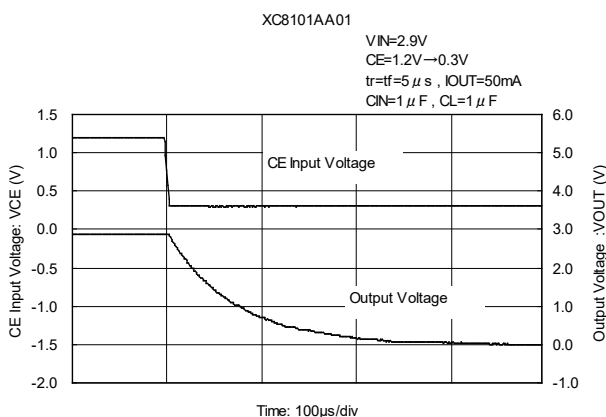
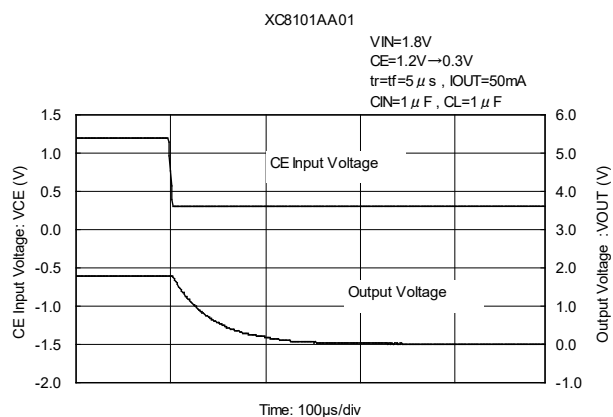
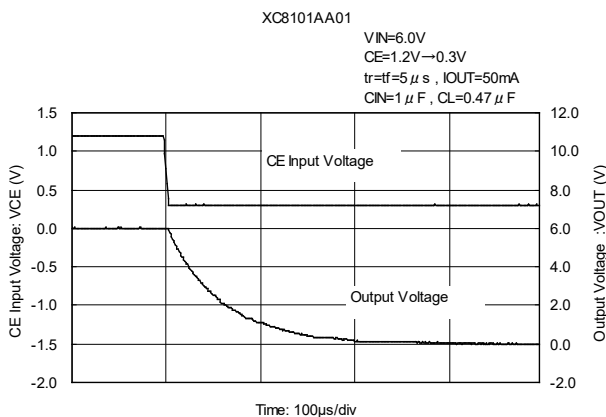
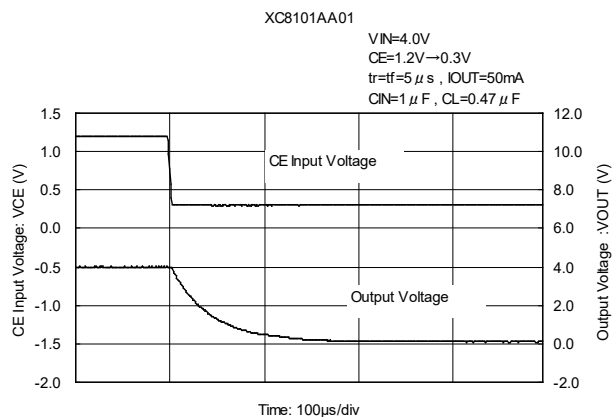

■ PACKAGING INFORMATION

For the latest package information go to, www.torexsemi.com/technical-support/packages

PACKAGE	OUTLINE / LAND PATTERN	THERMAL CHARACTERISTICS
SOT-25	SOT-25 PKG	SOT-25 Power Dissipation
SSOT-24	SSOT-24 PKG	SSOT-24 Power Dissipation
USP-4	USP-4 PKG	USP-4 Power Dissipation

MARKING RULE

●SOT-25、USP-4

① represents product series

MARK	PRODUCT SERIES
U	XC8101*****

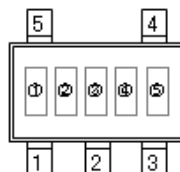

SOT-25
(TOP VIEW)

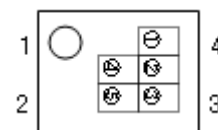

USP-4
(TOP VIEW)

② represents CE pin logic

MARK	PRODUCT SERIES
F	XC8101A*****

③ represents C_L Discharge Function

MARK	PRODUCT SERIES
C	XC8101AA****

④⑤ represents production lot number

01, ...,09, 0A, ...,0Z, 11, ..., 9Z, A1, ..., A9, AA, ..., Z9, ZA, ..., ZZ repeated.

(G, I, J, O, Q, W excluded)

*No character inversion used.

●SSOT-24

① represents product series

MARK	PRODUCT SERIES
U	XC8101*****

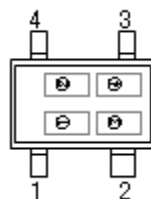

SSOT-24
(TOP VIEW)

② represents CE pin logic

MARK	PRODUCT SERIES
F	XC8101A*****

③④ represents production lot number

01, ...,09, 0A, ...,0Z, 11, ...,9Z, A1, ..., A9, AA, ..., Z9, ZA, ..., ZZ repeated.

(G, I, J, O, Q, W excluded)

*No character inversion used.

1. The product and product specifications contained herein are subject to change without notice to improve performance characteristics. Consult us, or our representatives before use, to confirm that the information in this datasheet is up to date.
2. The information in this datasheet is intended to illustrate the operation and characteristics of our products. We neither make warranties or representations with respect to the accuracy or completeness of the information contained in this datasheet nor grant any license to any intellectual property rights of ours or any third party concerning with the information in this datasheet.
3. Applicable export control laws and regulations should be complied and the procedures required by such laws and regulations should also be followed, when the product or any information contained in this datasheet is exported.
4. The product is neither intended nor warranted for use in equipment of systems which require extremely high levels of quality and/or reliability and/or a malfunction or failure which may cause loss of human life, bodily injury, serious property damage including but not limited to devices or equipment used in 1) nuclear facilities, 2) aerospace industry, 3) medical facilities, 4) automobile industry and other transportation industry and 5) safety devices and safety equipment to control combustions and explosions. Do not use the product for the above use unless agreed by us in writing in advance.
5. Although we make continuous efforts to improve the quality and reliability of our products; nevertheless Semiconductors are likely to fail with a certain probability. So in order to prevent personal injury and/or property damage resulting from such failure, customers are required to incorporate adequate safety measures in their designs, such as system fail safes, redundancy and fire prevention features.
6. Our products are not designed to be Radiation-resistant.
7. Please use the product listed in this datasheet within the specified ranges.
8. We assume no responsibility for damage or loss due to abnormal use.
9. All rights reserved. No part of this datasheet may be copied or reproduced unless agreed by Torex Semiconductor Ltd in writing in advance.

TOREX SEMICONDUCTOR LTD.