

TPS92200 4-V to 30-V Input Voltage, 1.5-A Output Current, Synchronous Buck LED Driver With Flexible Dimming Options

1 Features

- 4-V to 30-V wide input range
- Integrated 150-m Ω and 90-m Ω MOSFETs for 1.5-A continuous output current
- Ultra-low shut-down current: 1 μ A
- Ultra-low output discharge current from load: 1 μ A
- 1-MHz switching frequency
- Maximum duty cycle up to 99%
- Peak current mode with internal compensation
- Flexible dimming options:
 - TPS92200D1: PWM dimming with digital input and analog dimming with analog input
 - TPS92200D2: analog dimming with digital input
- Ultra-low and accurate FB voltage: 99 mV \pm 3 mV
- Full protection features:
 - LED open-load protection
 - LED+ short-to-GND protection with auto-retry
 - LED+ and LED– short circuitry protection with auto-retry
 - Sense-resistor open-load and short-to-GND protection with auto-retry
 - Thermal shutdown protection with auto-retry
- SOT23 (6) package
- VQFN-HR (6) package

2 Applications

- Video surveillance IR/White LED driver
- Facial recognition IR LED driver
- Stage lighting LED driver
- General industrial and commercial illumination
- Medical UV LED driver
- AA or Li-Ion battery charger

3 Description

The TPS92200 device is a 1.5-A synchronous buck LED driver with 30-V maximum input voltage. By integrating the high-side and low-side NMOS switches, the TPS92200 device provides high power density with high efficiency in an ultra-small solution size. The TPS92200 device uses peak-current-mode control and full internal compensation to provide high transient response performance over a wide range of operating conditions.

The TPS92200 device supports flexible dimming methods. TPS92200D1 implements both PWM and analog dimming modes. In PWM dimming mode, LEDs turn on and off according to PWM duty cycle periodically. The device's analog dimming mode is achieved by changing the internal reference voltage proportional to the voltage level of the analog input in 5% to 100% range. TPS92200D2 implements deeper analog dimming by changing the internal reference voltage proportional to the duty cycle of the PWM signal input in 1% to 100% range.

For safety and protection, the TPS92200 devices implement full protections, including LED open, LED+ short-to-GND, LED short, sense resistor open and short, and device thermal protection.

Device Information

PART NUMBER	PACKAGE	BODY SIZE (NOM)
TPS92200D1DDCR	SOT-23-THIN (6)	1.60 mm \times 2.90 mm
TPS92200D2DDCR	SOT-23-THIN (6)	1.60 mm \times 2.90 mm
TPS92200D1RXLR	VQFN-HR (6)	1.50 mm \times 2.00 mm
TPS92200D2RXLR	VQFN-HR (6)	1.50 mm \times 2.00 mm

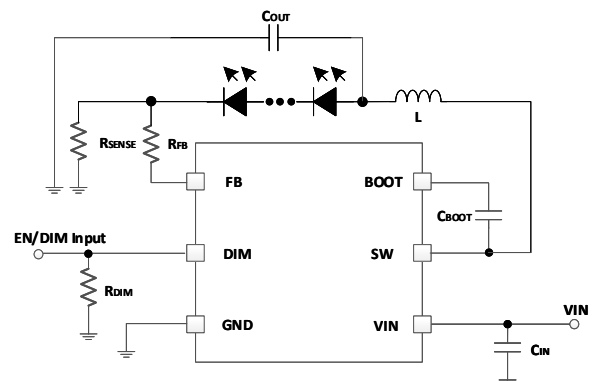

Simplified Schematic



Table of Contents

1 Features	1	7.3 Feature Description.....	11
2 Applications	1	7.4 Device Functional Modes.....	15
3 Description	1	8 Application and Implementation	17
4 Revision History	2	8.1 Application Information.....	17
5 Pin Configuration and Functions	3	8.2 Typical Application.....	17
6 Specifications	4	9 Power Supply Recommendations	30
6.1 Absolute Maximum Ratings.....	4	10 Layout	30
6.2 ESD Ratings.....	4	10.1 Layout Guidelines.....	30
6.3 Recommended Operating Conditions.....	4	10.2 Layout Example.....	30
6.4 Thermal Information.....	4	11 Device and Documentation Support	32
6.5 Electrical Characteristics.....	5	11.1 Receiving Notification of Documentation Updates..	32
6.6 Timing Requirements.....	6	11.2 Support Resources.....	32
Switching Characteristics.....	6	11.3 Trademarks.....	32
6.7 Typical Characteristics.....	7	11.4 Electrostatic Discharge Caution.....	32
7 Detailed Description	10	11.5 Glossary.....	32
7.1 Overview.....	10	12 Mechanical, Packaging, and Orderable Information	32
7.2 Functional Block Diagram.....	10		

4 Revision History

NOTE: Page numbers for previous revisions may differ from page numbers in the current version.

Changes from Revision A (September 2021) to Revision B (January 2022) Page

• Removed VQFN-HR package preview note.....	1
• Updated <i>ESD Ratings</i> table with correct description for CDM testing.....	4

Changes from Revision * (May 2020) to Revision A (September 2021) Page

• Updated the numbering format for tables, figures and cross-references throughout the document.....	1
• Added VQFN-HR package information.....	1
• Added VQFN-HR package information.....	1
• Add VQFN-HR package information.....	3
• Added VQFN-HR package information.....	30

5 Pin Configuration and Functions

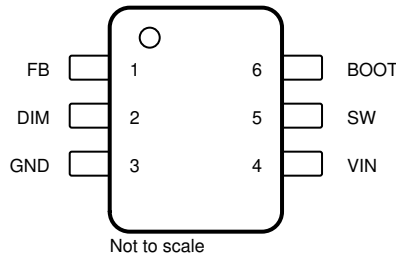

Figure 5-1. DDC Package 6-Pin SOT-23-THIN Top View

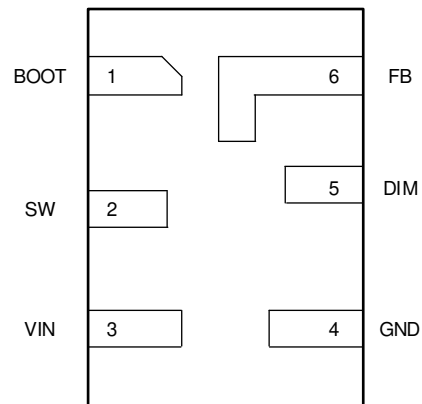

Figure 5-2. RXL Package 6-Pin VQFN-HR Top View

Table 5-1. Pin Functions

PIN			TYPE ⁽¹⁾	DESCRIPTION
NAME	DDC NO.	RXL NO.		
BOOT	6	1	O	A bootstrap capacitor is required between BOOT and SW.
FB	1	6	I	LED current detection feedback
GND	3	4	G	Power ground
DIM	2	5	I	Dimming input. In PWM dimming mode, LED current is turned ON and OFF according to PWM duty cycle periodically (TPS92200D1). In analog dimming mode, the internal reference is proportional to the analog voltage on DIM pin (TPS92200D1) or the PWM duty input (TPS92200D2).
SW	5	2	O	Switching node to external inductor
VIN	4	3	P	Input supply voltage

(1) I = Input, O = Output, P = Supply, G = Ground

6 Specifications

6.1 Absolute Maximum Ratings

over operating ambient temperature range (unless otherwise noted)⁽¹⁾

		MIN	MAX	UNIT
Input voltage range, V_I	IN	-0.3	32	V
	DIM	-0.3	7	V
	FB	-0.3	7	V
Output voltage range, V_O	BOOT-SW	-0.3	7	V
	SW	-0.3	32	V
	SW (20 ns transient)	-5	32	V
Operating junction temperature, T_J		-40	150	°C
Storage temperature range, T_{stg}		-65	150	°C

- (1) Stresses beyond those listed under *Absolute Maximum Ratings* may cause permanent damage to the device. These are stress ratings only, which do not imply functional operation of the device at these or any other conditions beyond those indicated under *Recommended Operating Conditions*. Exposure to absolute-maximum-rated conditions for extended periods may affect device reliability.

6.2 ESD Ratings

			VALUE	UNIT
$V_{(ESD)}$	Electrostatic discharge	Human-body model (HBM), per ANSI/ESDA/JEDEC JS-001 ⁽¹⁾	±2000	V
		Charged-device model (CDM), per ANSI/ESDA/JEDEC JS-002 ⁽²⁾	±500	

- (1) JEDEC document JEP155 states that 500-V HBM allows safe manufacturing with a standard ESD control process.
 (2) JEDEC document JEP157 states that 250-V CDM allows safe manufacturing with a standard ESD control process.

6.3 Recommended Operating Conditions

over operating ambient temperature range (unless otherwise noted)

		MIN	MAX	UNIT
Input voltage range	IN	4	30	V
	DIM	-0.1	6	V
	FB	-0.1	6	V
Output voltage range	BOOT-SW	-0.1	6	V
	SW	-0.1	30	V
Operating Junction temperature, T_J		-40	125	°C

6.4 Thermal Information

THERMAL METRIC ⁽¹⁾		TPS92200	TPS92200	UNIT
		DDC (SOT23-6)	RXL (VQFN-HR-6)	
		6 PINS	6 PINS	
$R_{\theta JA}$	Junction-to-ambient thermal resistance	123.4	136.1	°C/W
$R_{\theta JC(top)}$	Junction-to-case (top) thermal resistance	60.5	95.3	°C/W
$R_{\theta JB}$	Junction-to-board thermal resistance	41.4	49.3	°C/W
Ψ_{JT}	Junction-to-top characterization parameter	12.3	4.6	°C/W
Ψ_{JB}	Junction-to-board characterization parameter	40.9	48.1	°C/W

- (1) For more information about traditional and new thermal metrics, see the *Semiconductor and IC Package Thermal Metrics* application report, [SPRA953](#).

6.5 Electrical Characteristics

The electrical ratings specified in this section apply to all specifications in this document, unless otherwise noted. These specifications are interpreted as conditions that do not degrade the device parametric or functional specifications for the life of the product containing it. $T_J = -40^{\circ}\text{C}$ to $+125^{\circ}\text{C}$, $V_{IN} = 4\text{ V}$ to 30 V , (unless otherwise noted).

PARAMETER		TEST CONDITIONS	MIN	TYP	MAX	UNIT
INPUT SUPPLY						
V_{IN}	Input voltage range		4		30	V
V_{IN_UVLO}	V_{IN} undervoltage lockout	Rising V_{IN}	3.5	3.7	3.9	V
		Falling V_{IN}	3.3	3.5	3.7	V
	Hysteresis			0.2		V
I_{SD}	Shut down current from V_{IN}	$V_{IN} = 12\text{ V}$, $V_{DIM} = 0\text{ V}$		1	3	μA
I_{DISC}	Discharge current from SW and BOOT	V_{IN} floating, $V_{DIM} = 0\text{ V}$		1	3	μA
I_{OP}	Normal operating current	$V_{DIM} = 3.3\text{ V}$		0.5	1	mA
DIMMING						
V_{DIM_L}	Low-level input voltage				0.3	V
V_{DIM_H}	High-level input voltage		0.65			V
V_{ANA}	Analog dimming range (TPS92200D1 only)		0.65		1.2	V
t_{DIM_ON1}	DIM minimum on time to enable device (TPS92200D2 only)	$V_{DIM} = 3.3\text{ V}$		190	300	nS
t_{DIM_ON2}	DIM minimum on time when PWM dimming (TPS92200D2 only)	$V_{DIM} = 3.3\text{ V}$			150	nS
t_{DIM_OFF}	DIM minimum off time to disable device	$V_{DIM} = 0\text{ V}$		36		mS
FEEDBACK AND ERROR AMPLIFIER						
V_{FB_REF}	FB pin reference voltage	$V_{DIM} = 3.3\text{ V}$	96	99	102	mV
V_{FB_OVP}	FB pin over voltage protection threshold	$V_{DIM} = 3.3\text{ V}$		140		mV
V_{FB_DMAX}	FB reference voltage when maximum dimming input (TPS92200D1 only)	$V_{DIM} = 1.2\text{ V}$		99		mV
V_{FB_DMIN}	FB reference voltage when minimum dimming input (TPS92200D1 only)	$V_{DIM} = 0.65\text{ V}$		5		mV
	FB reference voltage when minimum dimming duty cycle (TPS92200D2 only)	DIM pin duty cycle $\leq 3\%$		1		mV
POWER STAGE						
R_{HS}	High-side FET on resistance	$V_{IN} \geq 5\text{ V}$		150		$\text{m}\Omega$
R_{LS}	Low-side FET on resistance	$V_{IN} \geq 5\text{ V}$		90		$\text{m}\Omega$
CURRENT LIMIT						
I_{LIM_HS}	High-side current limit		2.9	3.3	4	A
$I_{LIM_LS_SOUR}$	Low-side sourcing current limit		2.4	3	3.6	A
$I_{LIM_LS_SINK}$	Low-side sinking current limit		1.4	1.8	2.4	A
THERMAL PROTECTION						
T_{TSD}	Thermal shutdown temperature			165		$^{\circ}\text{C}$
	Hysteresis			15		$^{\circ}\text{C}$

6.6 Timing Requirements

		MIN	TYP	MAX	UNIT
Auto-Retry Timing					
t _{RETRY_ON}	Auto-retry on-time		512		Cycles
t _{RETRY_OFF}	Auto-retry off-time		60		ms
SOFT START					
t _{SS}	Internal soft-start time		0.5		ms

Switching Characteristics

T_J = –40°C to +125°C, V_{IN} = 4V to 30V, (unless otherwise noted).

PARAMETER		TEST CONDITIONS	MIN	TYP	MAX	UNIT
f _{sw}	Switching frequency		0.8	1	1.2	MHz
D _{MAX}	Maximum duty cycle			99%		
t _{MIN_ON}	Minimum on time			75	100	ns
t _{MIN_OFF}	Minimum off time			65	90	ns
t _{MAX_ON}	Maximum on time			6.6		us

6.7 Typical Characteristics

$V_{IN} = 12\text{ V}$, unless otherwise specified.

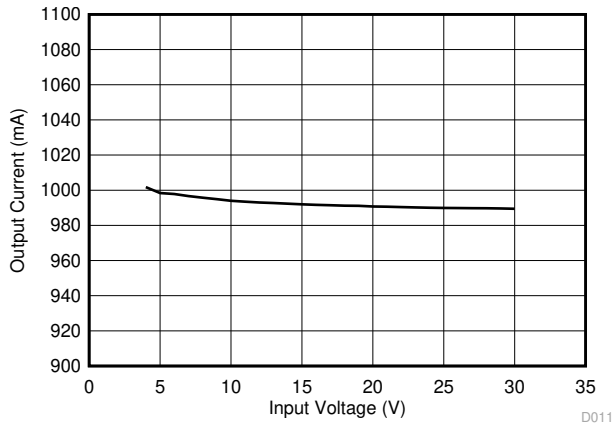

Figure 6-1. Output Current vs Input Voltage

D011

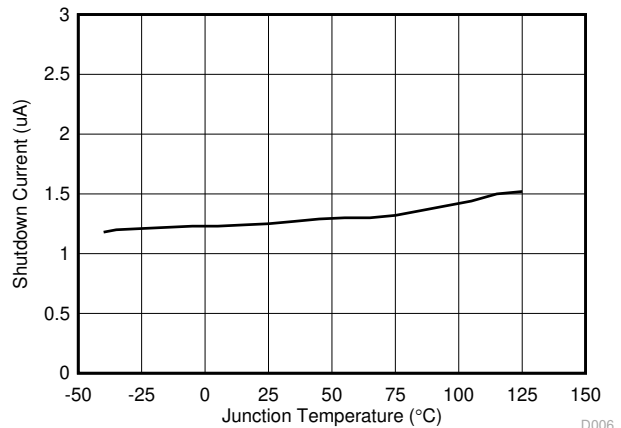

Figure 6-2. Shutdown Current vs Junction Temperature

D006

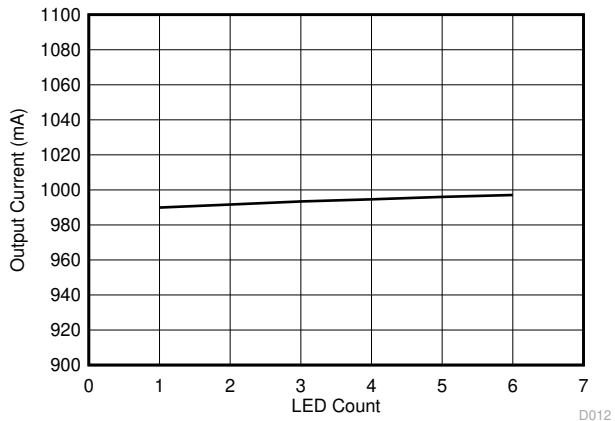

Figure 6-3. Output Current vs LED Count

D012

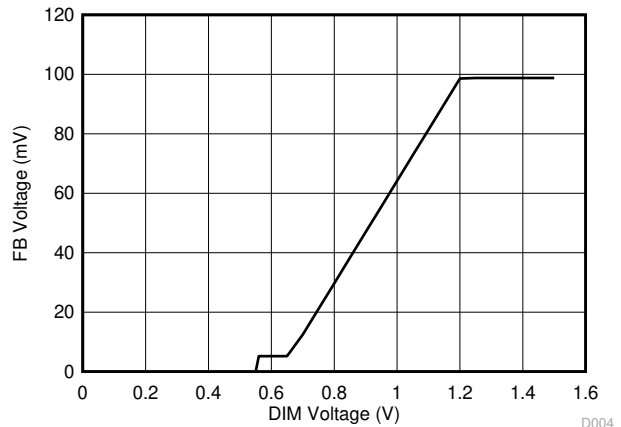

Figure 6-4. DIM Voltage vs FB Voltage in Analog Dimming (for TPS92200D1)

D004

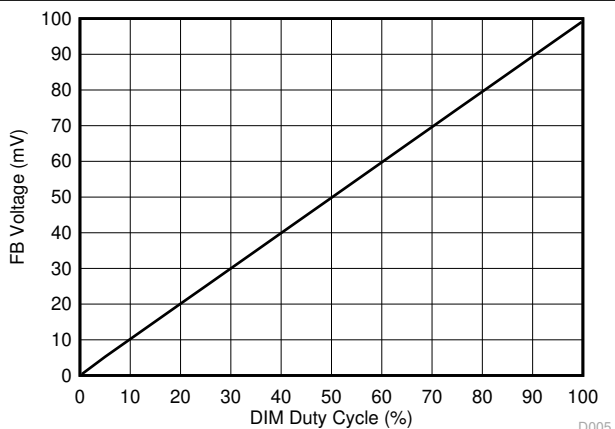

Figure 6-5. DIM Duty Cycle vs FB Voltage in Analog Dimming (for TPS92200D2)

D005

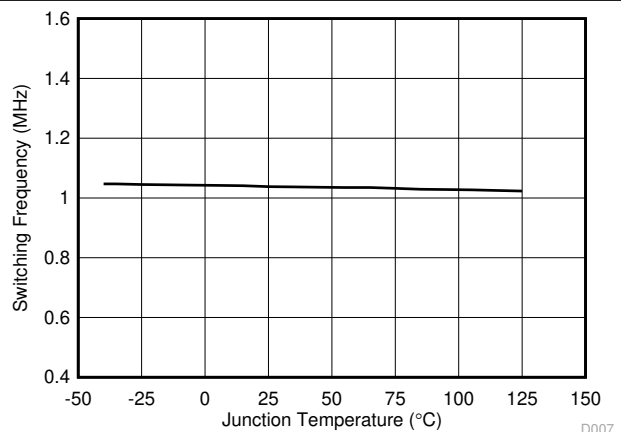

Figure 6-6. Switching Frequency vs Junction Temperature

D007

6.7 Typical Characteristics (continued)

$V_{IN} = 12\text{ V}$, unless otherwise specified.

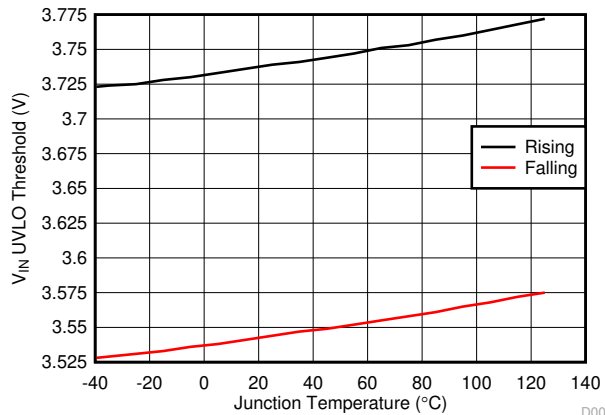

Figure 6-7. VIN UVLO Threshold vs Junction Temperature

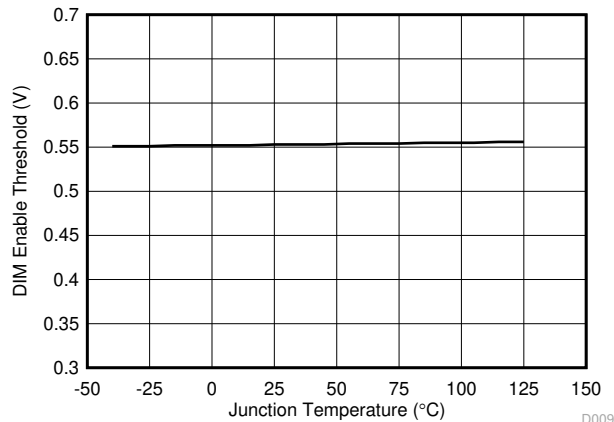

Figure 6-8. DIM Enable Threshold vs Junction Temperature

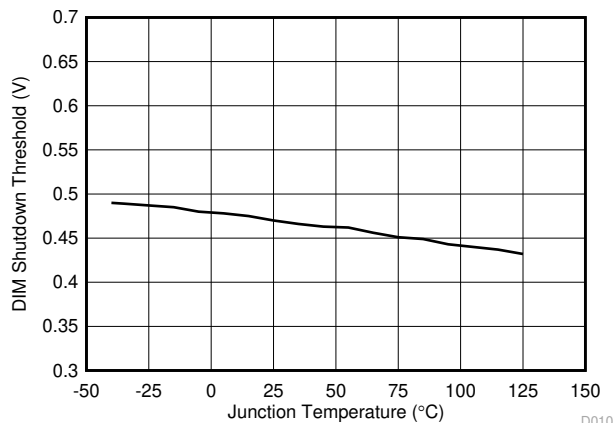

Figure 6-9. DIM Shutdown Threshold vs Junction Temperature

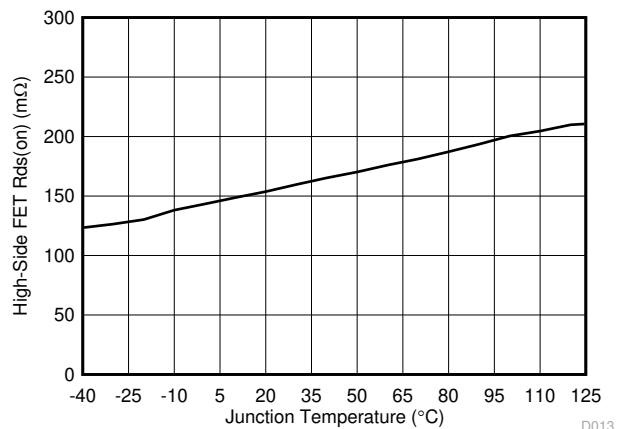

Figure 6-10. High-side FET On Resistance vs Junction Temperature

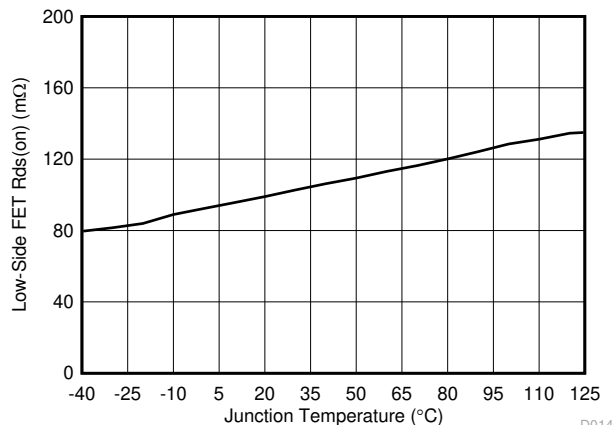

Figure 6-11. Low-Side FET On Resistance vs Junction Temperature

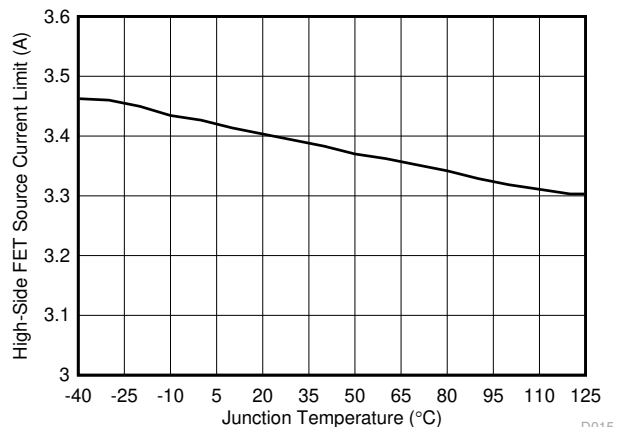

Figure 6-12. High-Side FET Source Current Limit vs Junction Temperature

6.7 Typical Characteristics (continued)

$V_{IN} = 12\text{ V}$, unless otherwise specified.

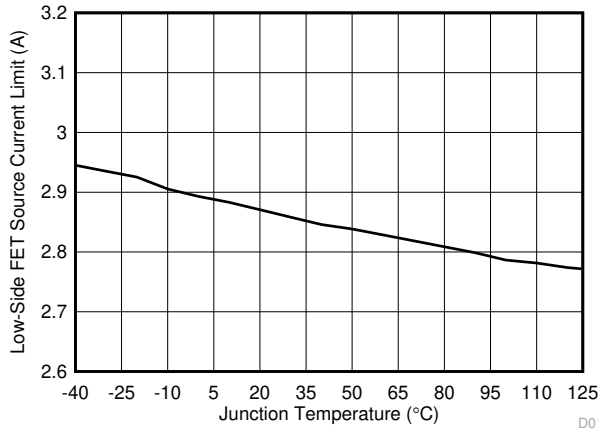

Figure 6-13. Low-Side FET Source Current Limit vs Junction Temperature

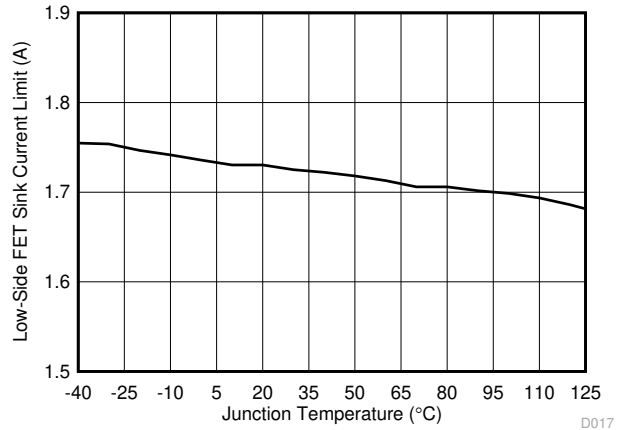

Figure 6-14. Low-Side FET Sink Current Limit vs Junction Temperature

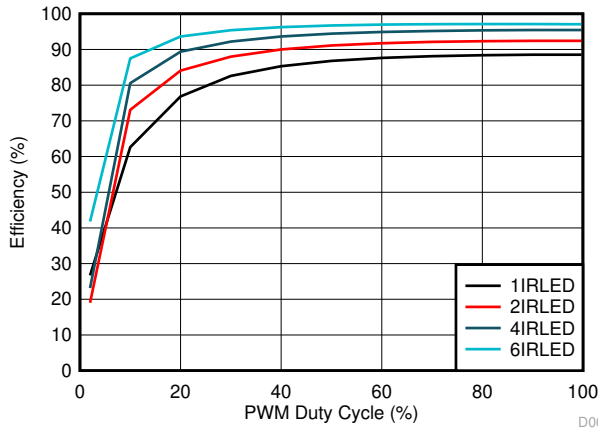

Figure 6-15. Efficiency at 1-A Output Current, 4.7-µH Inductor, 12-V Input Voltage

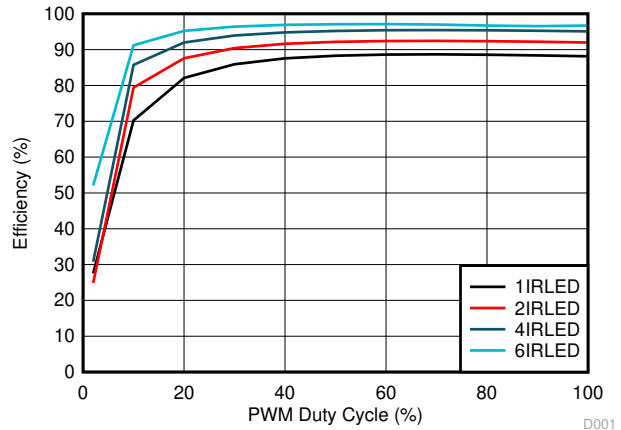

Figure 6-16. Efficiency at 1.5-A Output Current, 4.7-µH Inductor, 12-V Input Voltage

7 Detailed Description

7.1 Overview

The TPS92200 device is a 1.5-A synchronous buck LED driver with 30-V maximum input voltage. By integrating the high-side and low-side NMOS switches, the TPS92200 device provides high power density with high efficiency in an ultra-small solution size.

The TPS92200 device is fully internally compensated without additional external components, which enables a simple design on a limited board space. The device uses peak current mode control to regulate the LED current with high accuracy. Switching frequency is internally set to 1 MHz, allowing the use of extremely small surface-mount inductors and chip capacitors.

The TPS92200 devices support flexible dimming methods. TPS92200D1 implement both PWM and analog dimming modes. In PWM dimming mode, the LED turns on and off according to PWM duty cycle periodically. The device's analog dimming mode is achieved by changing the internal reference voltage proportional to the voltage level of the analog input in 5% to 100% range. TPS92200D2 implement deeper analog dimming by changing the internal reference voltage proportional to the duty cycle of the PWM signal input in 1% to 100% range.

For safety and protection, the TPS92200 devices implement full protections include LED open, LED+ short-to-GND, LED short, sense resistor open and short, and device thermal protection. Hiccup mode is triggered at current limit or FB pin overvoltage scenario to avoid the device overheats.

7.2 Functional Block Diagram

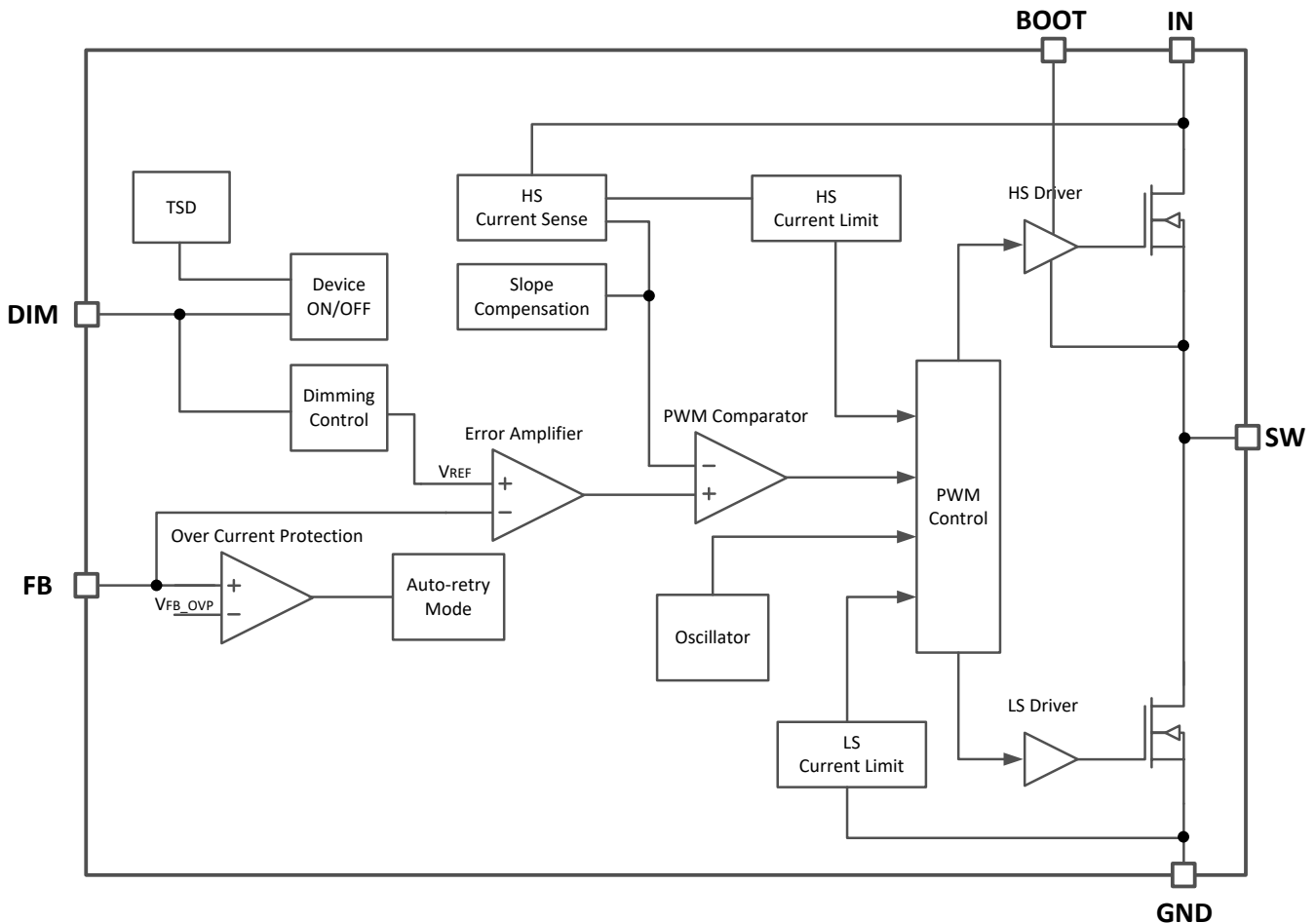

7.3 Feature Description

7.3.1 Peak-Current-Mode PWM Control

The TPS92200 device uses peak-current-mode control and full internal compensation to provide high transient response performance over a wide range of operating conditions. The switching frequency is internally set to 1 MHz when the minimum off time $t_{\text{MIN_OFF}}$ is not triggered, thus minimizing the external inductor and capacitor size.

During each switching cycle, when the high-side power switch is turned on, the load current is sensed through the external sense resistor, R_{SENSE} . The sensed voltage on the FB pin is compared with the internal voltage reference, V_{REF} , through the error amplifier. The output of the error amplifier, V_{COMP} , is compared with the real-time current, $I_{\text{HS_SENSE}}$, going through the high-side power switch. Slope compensation circuitry is implemented in the device to prevent sub-harmonic oscillations as the duty cycle increases in peak-current-control mode. When the peak value of $V_{\text{HS_SENSE}}$ reaches V_{COMP} in the PWM comparator, the high-side power switch is turned off and the low-side NMOS is turned on at the same time. The low-side power switch stays turned on until the end of the PWM cycle. Thus, by regulating the real-time peak current in each switching cycle, the device controls the load current at the target value.

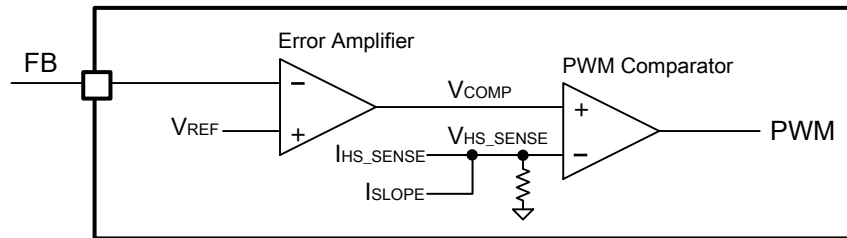

Figure 7-1. Error Amplifier and PWM Comparator

7.3.2 Setting LED Current

The LED current is set by the external resistor between the LEDs cathode and GND. Because the FB pin voltage reference $V_{\text{FB_REF}}$ is fixed at 99 mV, the sensing resistor can be calculated using [Equation 1](#).

$$R_{\text{SENSE}} = \frac{V_{\text{FB_REF}}}{I_{\text{LED}}} \quad (1)$$

7.3.3 Internal Soft Start

The TPS92200 device implements the internal soft-start function. The V_{REF} ramps smoothly during the soft-start period. The internal soft-start period is set as t_{SS} , 0.5 ms typically.

7.3.4 Input Undervoltage Lockout

The device implements internal Undervoltage Lockout (UVLO) circuitry on the IN pin. The device is disabled when the IN pin voltage falls below the internal IN UVLO threshold, 3.5-V typical. The internal IN UVLO threshold has a hysteresis of 0.2-V typical.

7.3.5 Bootstrap Regulator

The TPS92200 integrates a bootstrap regulator inside, and requires an external capacitor between the BOOT and SW pins to provide the gate driver voltage for the high-side power switch. TI recommends a 0.1- μF ceramic capacitor with an X7R or X5R dielectric because of the stable characteristics over temperature and voltage.

7.3.6 Maximum Duty Cycle

For a buck LED driver, the maximum duty cycle is limited by the minimum off time $t_{\text{MIN_OFF}}$ and switching frequency. To achieve the maximum brightness when the input voltage is close to output voltage, the TPS92200 device has a mechanism to decrease the switching frequency. This mechanism extends the on-time up to $t_{\text{MAX_ON}}$, 6.6 μs (typical). With this function, the TPS92200 device maximum duty cycle is able to go up to D_{MAX} , 99% (typical).

7.3.7 Overcurrent Protection

The device is protected from overcurrent conditions by cycle-by-cycle current limiting on both the high-side NMOS and the low-side NMOS.

7.3.7.1 High-Side MOSFET Overcurrent Protection

During each switching on cycle, the high-side sense voltage, V_{HS_SENSE} , is compared with V_{COMP} to generate the PWM duty cycle. To prevent an overcurrent stress, V_{COMP} is internally clamped to set the high-side NMOS current limit as I_{LIM_HS} . When the peak of I_{HS_SENSE} exceeds I_{LIM_HS} , the high-side MOSFET is turned off and the low-side MOSFET is turned on accordingly. An auto-retry mechanism is implemented for this case, if an output overcurrent condition occurs for more than auto-retry on time t_{RETRY_ON} , which is programmed for 512 switching cycles, the device shuts down for an auto-retry off-time t_{RETRY_OFF} , which is 60 ms typically.

7.3.7.2 Low-Side MOSFET Sourcing Overcurrent Protection

During each switching off-cycle, the low-side MOSFET is turned on and the conduction current is monitored by the internal circuitry. At the end of every clock cycle, the low-side MOSFET sourcing current is compared to the internally set low-side sourcing-current limit, $I_{LIM_LS_SOUR}$. If the low-side sourcing-current limit is exceeded, the high-side MOSFET does not turn on and the low-side MOSFET stays on for the next clock cycle. The high-side MOSFET turns on again when the low-side current is below the low-side sourcing current limit at the start of a cycle.

7.3.7.3 Low-Side MOSFET Sinking Overcurrent Protection

During each switching off-cycle, the device also monitors the sinking current of the low-side MOSFET by detecting the voltage across it and setting a sinking overcurrent limit, $I_{LIM_LS_SINK}$, to protect the low-side power switch from overstress. When the peak of the sinking current reaches $I_{LIM_LS_SINK}$, both the high-side MOSFET and low-side MOSFET are turned off. The high-side MOSFET turns on again when the low-side current is below the low side sinking current-limit at the start of a new cycle.

7.3.8 Fault Protection

The device is protected from several kinds of fault conditions, such as LED open and short, sense resistor open and short, and thermal shutdown.

Table 7-1. Protections

TYPE	CRITERION	BEHAVIOR
LED open load	V_{FB} close to 0 mV	The device keeps maximum duty cycle turn-on.
LED+ and LED– short circuit	$V_{FB} > V_{FB_OVP}$	When $V_{FB} > V_{FB_OVP}$, the device keeps the minimum on-time, and starts the auto-retry timer. During the auto-retry mode, the device is protected by the overcurrent limits.
LED+ short-to-GND	High-side or low-side NMOS current limit triggered	When the high-side or low-side MOSFET current limit is triggered, the device starts the auto-retry timer.
Sense-resistor open load	$V_{FB} > V_{FB_OVP}$	When $V_{FB} > V_{FB_OVP}$, the device keeps the minimum on-time, and starts the auto-retry timer.
Sense-resistor short circuit to GND	High-side or low-side MOSFET current limit triggered	When the high-side or low-side MOSFET current limit is triggered, the device starts the auto-retry timer.
Thermal shutdown	$T_J > T_{TSD}$	Disable the device when $T_J > T_{TSD}$, re-activate the device when T_J falls below the hysteresis level.

7.3.8.1 LED Open-Load Protection

When LED load is open, V_{FB} voltage is low. The internal error amplifier output voltage, V_{COMP} , is driven high and clamped. The high-side MOSFET is forced to turn on with the maximum PWM duty cycle, D_{MAX} .

7.3.8.2 LED+ and LED– Short Circuit Protection

When LED+ and LED– are shorted, V_{FB} is higher than internal reference voltage, V_{REF} , and internal error amplifier output voltage V_{COMP} is driven low and clamped. The high-side MOSFET is forced to turn on with the minimum on-time each cycle, t_{MIN_ON} . In this case, if the output voltage is too low, the inductor current cannot balance in a cycle, causing current runaway. Finally, the inductor current is clamped by low-side MOSFET sourcing current limit $I_{LIM_LS_SOUR}$ which is 3-A typical. If V_{FB} rises higher than V_{FB_OVP} , the device starts the auto-retry timer. After the counter, t_{RETRY_ON} , expires, the device shuts down and starts another counter, t_{RETRY_OFF} . During the shutdown period, both high-side and low-side MOSFETs are turned off. After the hiccup timer expires, TPS92200 restarts again. The device repeats these behaviors until the failure condition is removed. During the auto-retry mode, the device is also protected by the overcurrent limits of both high-side power switch and low-side power switch.

7.3.8.3 LED+ Short Circuit to GND Protection

When LED+ is shorted to GND, V_{FB} is low and V_{COMP} is driven high and clamped. The high-side MOSFET is forced to turn on with maximum PWM duty cycle, after either the high-side or low-side overcurrent limit is triggered, the device starts the auto-retry counter. When the counter t_{RETRY_ON} expires, the device shuts down and starts another counter t_{RETRY_OFF} . During the shutdown period, both high-side and low-side NMOSs are switched off. The device repeats these actions until the failure condition is removed.

7.3.8.4 Sense-Resistor Open-Load Protection

When the R_{SENSE} load is open, V_{FB} is higher than V_{REF} , and V_{COMP} is driven low and clamped. The high-side NMOS is forced to turn on with the minimum on-time each cycle, t_{MIN_ON} . If V_{FB} rises higher than V_{FB_OVP} , the device starts the auto-retry timer. After the counter t_{RETRY_ON} expires, the device shuts down and starts another counter t_{RETRY_OFF} . During the shutdown period, both high-side and low-side NMOSs are switched off. The device repeats these actions until the failure condition is removed. To prevent the FB pin from overvoltage damage during the t_{RETRY_ON} period, the FB pin implements a comparator with a 1-V threshold. If $V_{FB} > 1$ V, both high-side and low-side NMOSs are switched off immediately and the t_{RETRY_OFF} counter starts.

7.3.8.5 Sense Resistor Short Circuit-to-GND Protection

When R_{SENSE} is shorted to GND, V_{FB} is low and V_{COMP} is driven high and clamped. After the current reaches either the high-side overcurrent limit or low-side overcurrent limit, the device starts the auto-retry counter. After the t_{RETRY_ON} counter expires, the device shuts down and starts another counter, t_{RETRY_OFF} . During the shutdown period, both high-side and low-side NMOSs are switched off. The device repeats these actions until the failure condition is removed.

7.3.8.6 Overvoltage Protection

When the FB pin, for some reason, has a voltage higher than 1-V applied, the device shuts down immediately. Both high-side and low-side MOSFETs are kept off, and the device starts the auto-retry counter, t_{RETRY_OFF} . When the counter t_{RETRY_OFF} expires, the device restarts again. If the failure still exists, TPS92200 repeats above hiccup shutdown and restart process.

7.3.8.7 Thermal Shutdown

The TPS92200 device implements a thermal shutdown mechanism to protect the device from damage due to overheating. When the junction temperature rises to 160°C (typical), the device shuts down immediately. The TPS92200 device releases thermal shutdown when the junction temperature of the device is reduced to 145°C (typical).

7.4 Device Functional Modes

Table 7-2. Functional Modes

Device Name	DIM Pin Constant High	DIM Pin Constant Low	Dimming Input Type	Dimming Output Type
TPS92200D1	Device full on	Device turned off	<ul style="list-style-type: none"> Digital signal Amplitude: $V_H > 1.4\text{ V}$ and $V_L < 0.3\text{ V}$ Frequency: 100 Hz–2 kHz 	PWM Dimming
			<ul style="list-style-type: none"> Analog voltage Amplitude: 0.65 V–1.2 V 	5%–100% Analog Dimming
TPS92200D2			<ul style="list-style-type: none"> Digital signal Frequency: 20 kHz–200 kHz 	1%–100% Analog Dimming

7.4.1 Enable and Disable the Device

The DIM pin performs not only the dimming function, but also the enable-and-disable function. When the V_{IN} voltage is above the UVLO threshold, the TPS92200 device can be enabled by driving the DIM pin higher than the threshold voltage V_{DIM_H} for a period longer than t_{DIM_ON1} . To disable the device, the DIM pin must be kept lower than the threshold voltage V_{DIM_L} for a period longer than t_{DIM_OFF} . External pulldown is required to set the device as default-disabled, because the DIM pin is designed as a high-impedance input.

7.4.2 TPS92200D1 PWM Dimming

For the TPS92200D1 version, when applying a digital signal on the DIM pin, the device enters into PWM dimming mode. The amplitude of the digital signal must be higher than 1.4 V for high level and less than 0.3 V for low level, which is out of the analog dimming range (0.65 V–1.2 V). TI recommends the frequency of the digital signal be from 100 Hz to 2 kHz to achieve good dimming accuracy. In PWM dimming mode, the output turns on and off simultaneously with the digital-input high and low pulses, respectively.

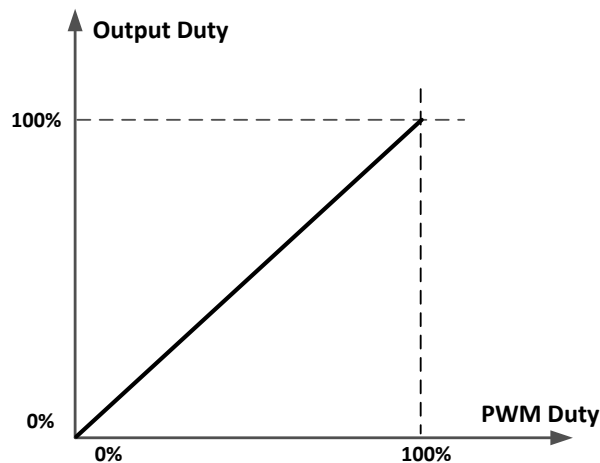

Figure 7-2. TPS92200D1 PWM Dimming

7.4.3 TPS92200D1 Analog Dimming

For the TPS92200D1 version, when applying an analog voltage on the DIM pin and the amplitude is between 0.65 V and 1.2 V, the device enters into analog dimming mode, and the reference voltage V_{REF} is changed proportionally to the analog input level. When $V_{DIM} = 0.65\text{ V}$, the reference voltage is 5 mV. When $V_{DIM} = 1.2\text{ V}$, the reference voltage is 99 mV.

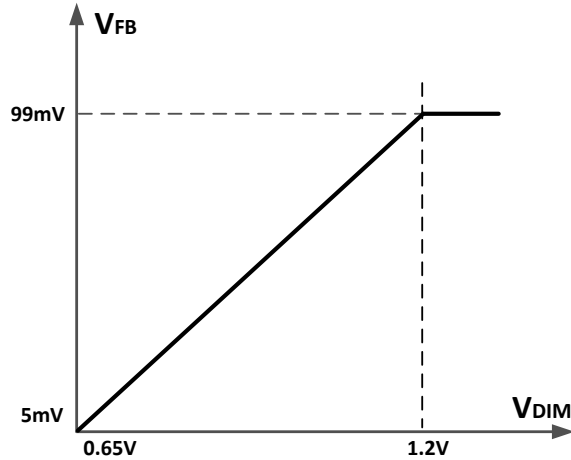

Figure 7-3. TPS92200D1 Analog Dimming

7.4.4 TPS92200D2 Analog Dimming

The TPS92200D2 version supports accurate analog dimming with a digital signal. When applying a digital signal on the DIM pin, the device enters into analog dimming mode, and the reference voltage V_{REF} is changed proportionally to the duty cycle of digital input. The frequency of the digital signal must be within the range of 20 kHz to 200 kHz.

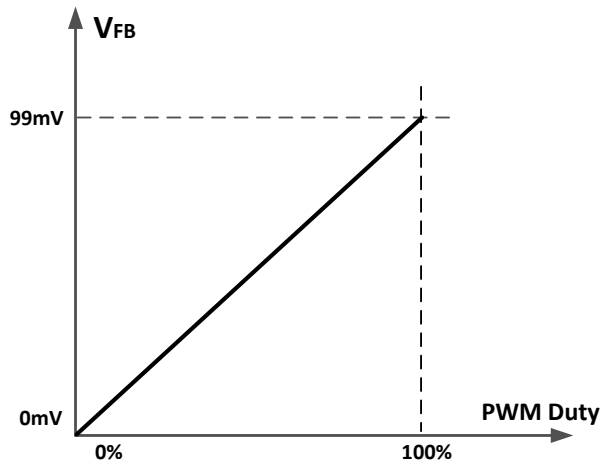

Figure 7-4. TPS92200D2 Analog Dimming

8 Application and Implementation

Note

Information in the following applications sections is not part of the TI component specification, and TI does not warrant its accuracy or completeness. TI's customers are responsible for determining suitability of components for their purposes, as well as validating and testing their design implementation to confirm system functionality.

8.1 Application Information

The TPS92200 device is typically used as a buck converter to drive one or more LEDs from a 4-V to 30-V input.

8.2 Typical Application

8.2.1 TPS92200D1 12-V Input, 1.5-A, 2-Piece IR LED Driver With Analog Dimming

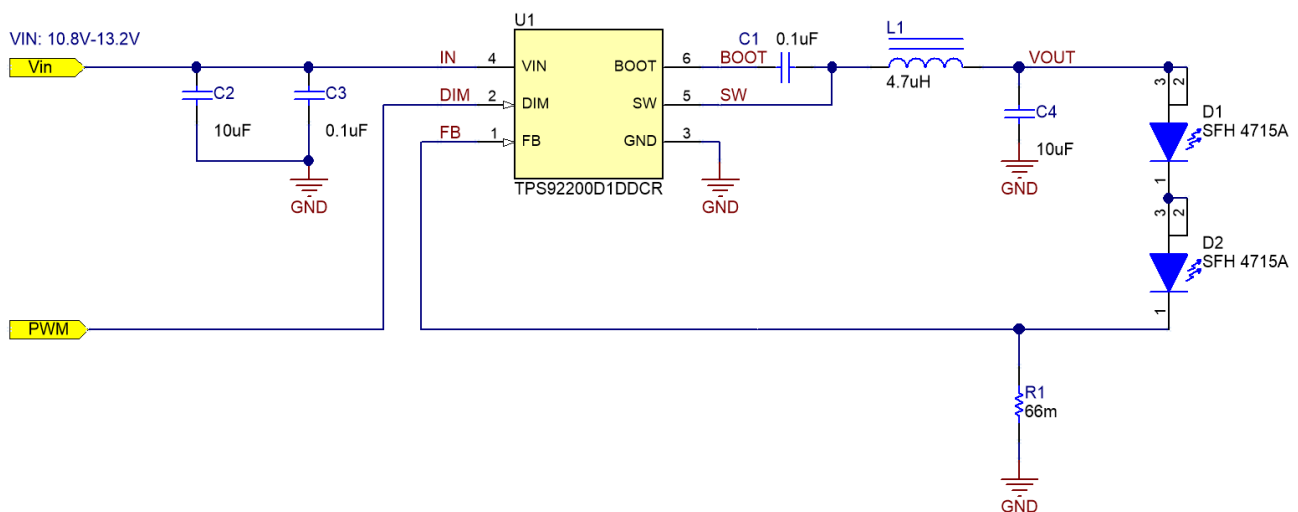

Figure 8-1. 12-VIN, 1.5-A, 2-piece IR LED, Analog Dimming Reference Design

8.2.1.1 Design Requirements

For this design example, use the parameters in the following table.

Table 8-1. Design Parameters

PARAMETER	VALUE
Input voltage range	12 V \pm 10%
LED forward voltage	1.75 V
Output voltage	3.6 V (1.75 \times 2 + 0.1)
Maximum LED current	1.5 A
Inductor current ripple	30% of maximum LED current
LED current ripple	20 mA or less
Input voltage ripple	200 mV or less
Dimming type	Analog dimming with TPS92200D1: 0.65-V to 1.2-V analog input on DIM pin

8.2.1.2 Detailed Design Procedure

8.2.1.2.1 Inductor Selection

Use Equation 2 to calculate the recommended value of the output inductor L.

$$L = \frac{V_{OUT} \times (V_{VIN(max)} - V_{OUT})}{V_{VIN(max)} \times K_{IND} \times I_{LED} \times f_{SW}} \quad (2)$$

where

- K_{IND} is a coefficient that represents the amount of inductor ripple current relative to the maximum LED current.
- I_{LED} is the maximum LED current.
- V_{OUT} is the sum of the voltage across the LED load and the voltage across the sense resistor.

In general, the value of K_{IND} is suggested between 0.2 and 0.4. For the application that can tolerate higher LED current ripple or use larger output capacitors, one can choose 0.4 for K_{IND} , otherwise, smaller K_{IND} like 0.2 can be chosen to get smaller LED current ripple.

With the chosen inductor value, the user can calculate the actual inductor current ripple using [Equation 3](#).

$$I_{L(ripple)} = \frac{V_{OUT} \times (V_{VIN(max)} - V_{OUT})}{V_{VIN(max)} \times L \times f_{SW}} \quad (3)$$

For TPS92200, TI suggests that the inductor current ripple be larger than 300 mA to assure loop stability. If the calculated inductor current ripple is less than 300 mA, TI suggests a smaller inductor.

The inductor RMS current and saturation-current ratings must be greater than those seen in the application. These ratings ensure that the inductor does not overheat or saturate. During power up, transient conditions, or fault conditions, the inductor current can exceed its normal operating current. For this reason, the most conservative approach is to specify an inductor with a saturation current rating equal to or greater than the converter current limit. This action is not always possible due to application size limitations. The peak-inductor-current and RMS current equations are shown in [Equation 4](#) and [Equation 5](#).

$$I_{L(peak)} = I_{LED} + \frac{I_{L(ripple)}}{2} \quad (4)$$

$$I_{L(rms)} = \sqrt{I_{LED}^2 + \frac{I_{L(ripple)}^2}{12}} \quad (5)$$

In this design, $V_{IN(max)} = 13.2$ V, $V_{OUT} = 3.6$ V, $I_{LED} = 1.5$ A, choose $K_{IND} = 0.3$, the calculated inductance is 5.8- μ H. A 4.7- μ H inductor is chosen. With this inductor, the ripple, peak, and RMS currents of the inductor are 0.56 A, 1.78 A and 1.51 A respectively. The chosen inductor has ample margin.

8.2.1.2.2 Input Capacitor Selection

The device requires an input capacitor to reduce the surge current drawn from the input supply and the switching noise from the device. Ceramic capacitors with X5R or X7R dielectrics are highly recommended because of their low ESR and small temperature coefficients. For most applications, a 10- μ F capacitor with an additional 0.1- μ F capacitor from VIN to GND to provide additional high-frequency filtering is enough. The input capacitor voltage rating must be greater than the maximum input voltage.

In this design, a 10- μ F, 35-V X7R ceramic capacitor is chosen. This yields around 40-mV input ripple voltage.

8.2.1.2.3 Output Capacitor Selection

The output capacitor reduces the high-frequency ripple current through the LED string. Various guidelines disclose how much high-frequency ripple current is acceptable in the LED string. Excessive ripple current in the LED string increases the RMS current in the LED string, and therefore the LED temperature also increases.

1. Calculate the total dynamic resistance of the LED string (R_{LED}) using the LED manufacturer's data sheet.

2. Calculate the required impedance of the output capacitor (Z_{OUT}) given the acceptable peak-to-peak ripple current through the LED string, I_{LED(ripple)} × I_{L(ripple)}, is the peak-to-peak inductor ripple current as calculated previously in inductor selection.
3. Calculate the minimum effective output capacitance required.
4. Increase the output capacitance appropriately due to the derating effect of applied dc voltage.

See [Equation 6](#), [Equation 7](#), and [Equation 8](#).

$$R_{LED} = \frac{\Delta V_F}{\Delta I_F} \times \# \text{ of LEDs} \quad (6)$$

$$Z_{COUT} = \frac{(R_{LED} + R_{SENSE}) \times I_{LED(ripple)}}{I_{L(ripple)} - I_{LED(ripple)}} \quad (7)$$

$$C_{OUT} = \frac{1}{2\pi \times f_{SW} \times Z_{COUT}} \quad (8)$$

After the output capacitor is chosen, [Equation 9](#) can be used to estimate the peak-to-peak ripple current through the LED string.

$$I_{LED(ripple)} = \frac{Z_{COUT} \times I_{L(ripple)}}{Z_{COUT} + R_{LED} + R_{SENSE}} \quad (9)$$

OSRAM SFH4715A IR LED is used here. The dynamic resistance of this LED is 0.29 ohm at 1.5-A forward current. Ceramic capacitors with X5R or X7R dielectrics are highly recommended because of their low ESR and small temperature coefficients. In this design, a 10-μF, 35-V X7R ceramic capacitor is chosen, the part number is GRM32ER7YA106KA12L. The calculated ripple current of the LED is about 23.8 mA.

8.2.1.2.3.1 Sense Resistor Selection

The maximum LED current is 1.5 A at 100% PWM duty and the corresponding V_{REF} is 99 mV. By using [Equation 1](#), calculate the needed sense resistance at 66 mΩ. Pay close attention to the power consumption of the sense resistor in this design at 148.5 mW, and make sure the chosen resistor has enough margin in its power rating.

8.2.1.2.3.1.1 Other External Components Selection

In this design, a 0.1-μF, 50-V X7R ceramic capacitor is chosen for C_{BOOT}.

8.2.1.3 Application Curves

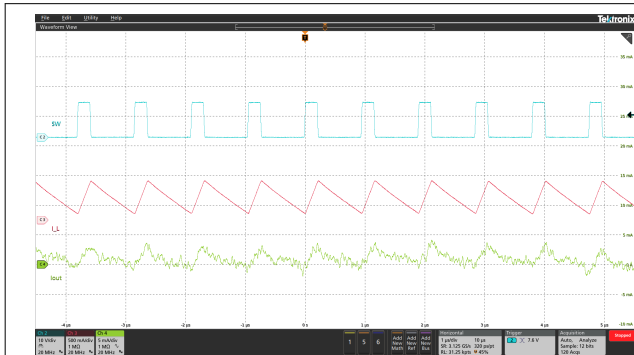

Blue: SW, Red: Inductor Current, Green: LED Current Ripple (AC)

Figure 8-2. LED Current Ripple at $V_{DIM} = 0.65\text{ V}$

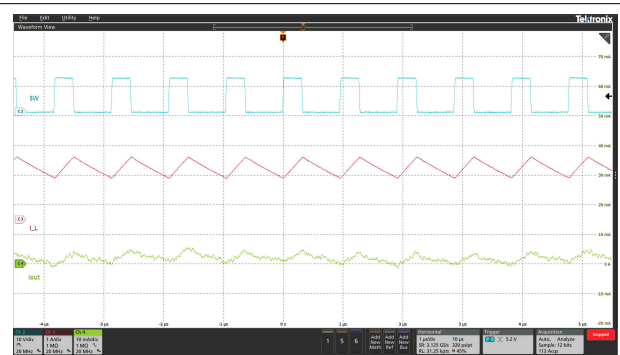

Blue: SW, Red: Inductor Current, Green: LED Current Ripple (AC)

Figure 8-3. LED Current Ripple at $V_{DIM} = 1.2\text{ V}$

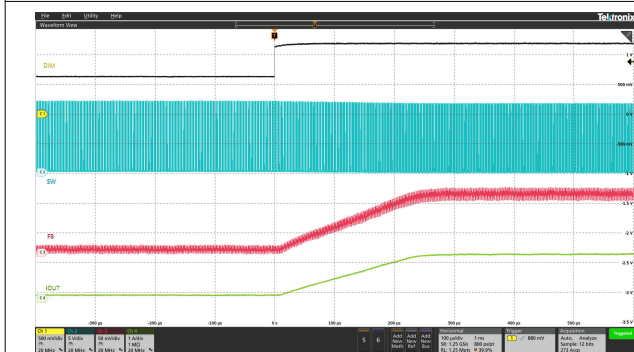

Black: DIM, Blue: SW, Red: FB, Green: LED Current

Figure 8-4. LED Current Transient for a V_{DIM} Transition From 0.65 V to 1.2 V

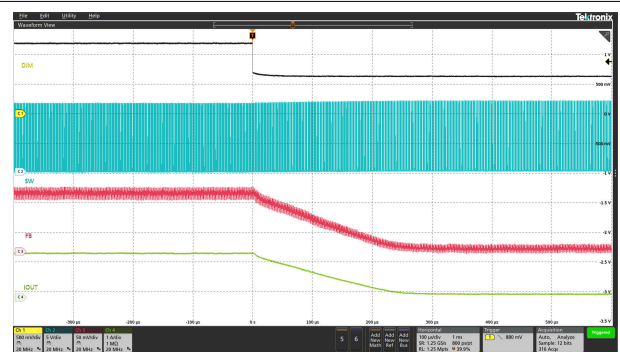

Black: DIM, Blue: SW, Red: FB, Green: LED Current

Figure 8-5. LED Current Transient for a V_{DIM} Transition From 1.2 V to 0.65 V

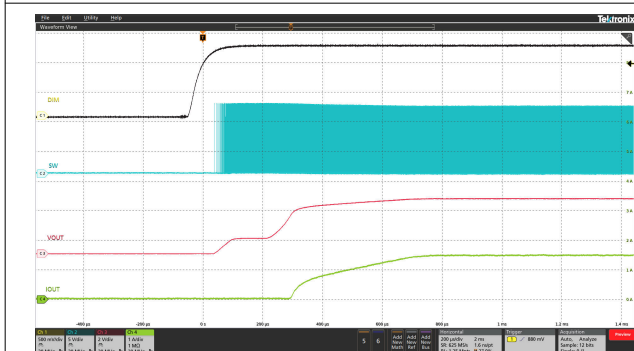

Black: DIM, Blue: SW, Red: VOUT, Green: LED Current

Figure 8-6. Start-Up at $V_{DIM} = 1.2\text{ V}$

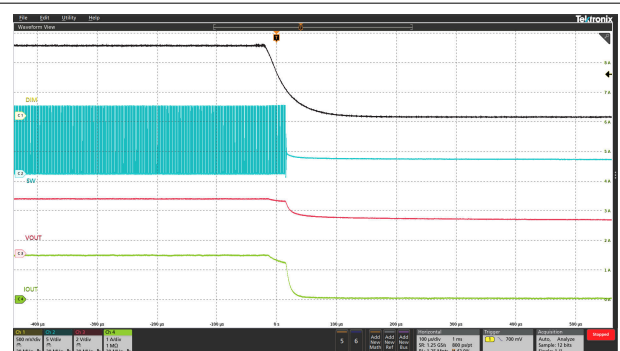

Black: DIM, Blue: SW, Red: VOUT, Green: LED Current

Figure 8-7. Shutdown at $V_{DIM} = 1.2\text{ V}$

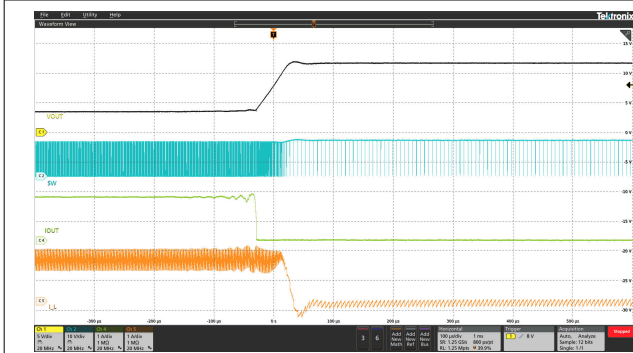

Black: Vout, Blue: SW, Green: LED Current, Orange: Inductor Current

Figure 8-8. LED Open-Load Protection

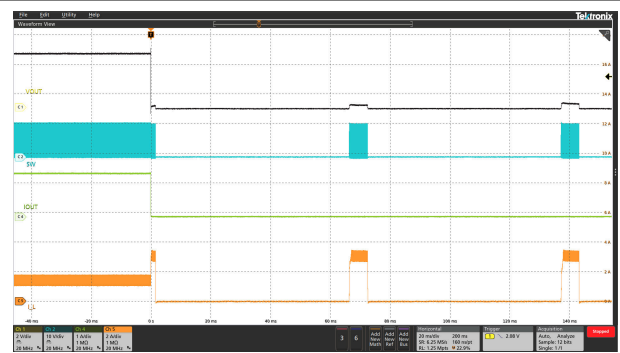

Black: Vout, Blue: SW, Green: LED Current, Orange: Inductor Current

Figure 8-9. LED+ Short-to-GND Protection

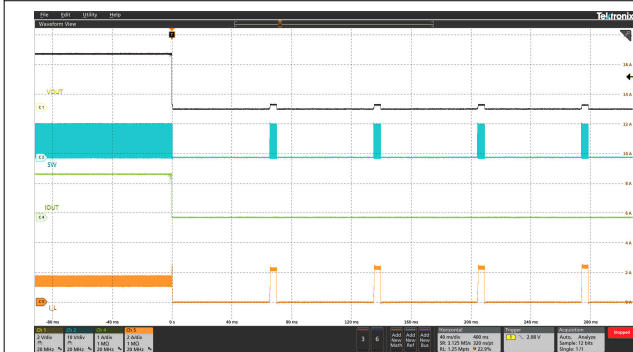

Black: Vout, Blue: SW, Green: LED Current, Orange: Inductor Current

Figure 8-10. LED+ and LED- Short Circuit-

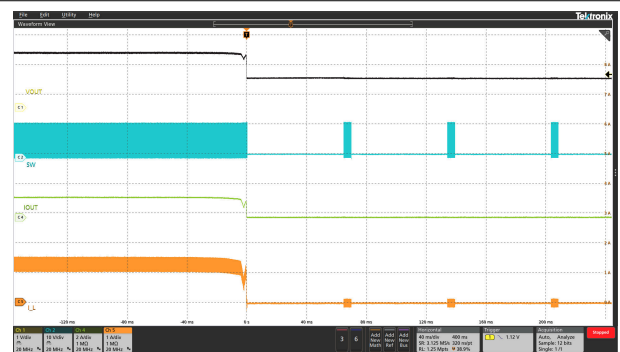

Black: Vout, Blue: SW, Green: LED Current, Orange: Inductor Current

Figure 8-11. Sense-Resistor Open-Load Protection

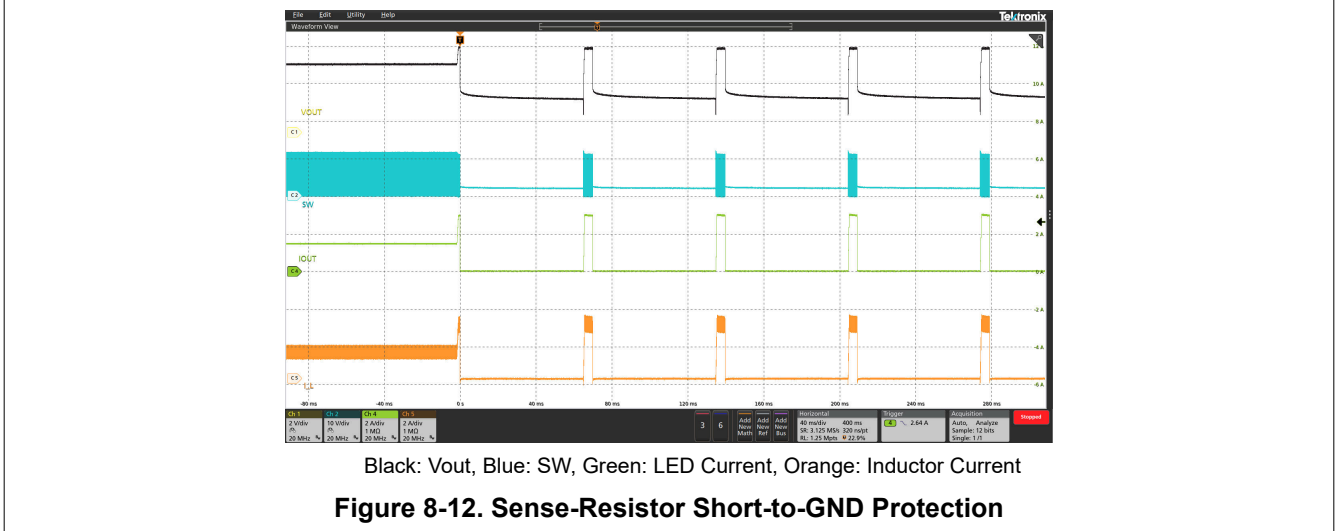

Black: Vout, Blue: SW, Green: LED Current, Orange: Inductor Current

Figure 8-12. Sense-Resistor Short-to-GND Protection

8.2.2 TPS92200D1 24-V Input, 1-A, 6-Piece WLED Driver With PWM Dimming

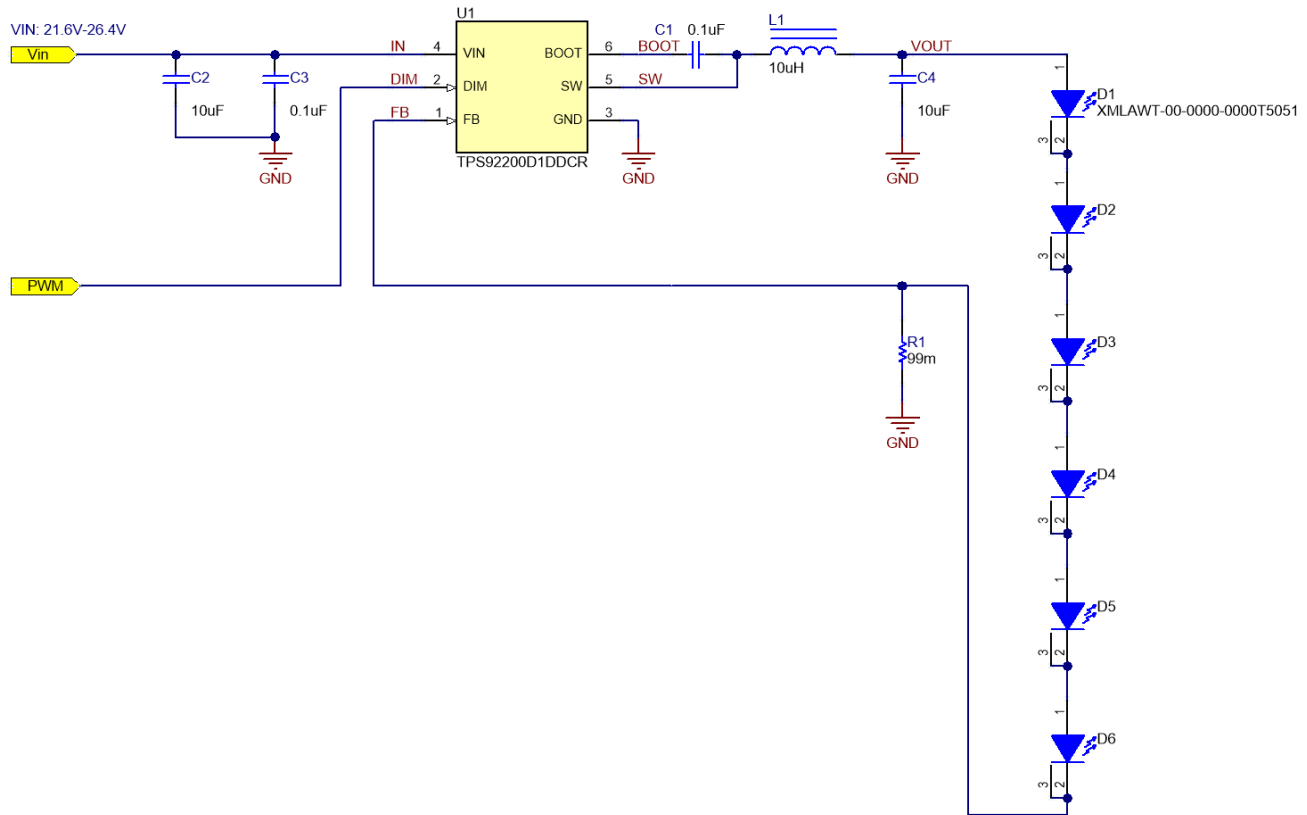

Figure 8-13. 24-VIN, 1-A, 6-piece WLED, PWM Dimming Reference Design

8.2.2.1 Design Requirements

For this design example, use the parameters in the following table.

Table 8-2. Design Parameters

PARAMETER	VALUE
Input voltage range	24 V \pm 10%
LED forward voltage	3 V
Output voltage	18.1 V (3 \times 6 + 0.1)
Maximum LED current	1 A
Inductor current ripple	60% of maximum LED current
LED current ripple	20 mA or less
Input voltage ripple	200 mV or less
Dimming type	PWM dimming with TPS92200D1: 500 Hz, 1% to 100% duty cycle input on the DIM pin

8.2.2.2 Detailed Design Procedure

8.2.2.2.1 Inductor Selection

For this application, input voltage is 24-V rail with 10% variation, output is 6 white LEDs in series and the inductor current ripple requirement is less than 60% of maximum LED current. To choose a proper peak-to-peak inductor current ripple, the low-side FET sink current limit must not be violated when the converter works in no-load condition. This action requires the half of peak-to-peak inductor current ripple to be lower than that limit. Another consideration is the increased core loss and copper loss in the inductor with this larger peak-to-peak

current ripple which is also acceptable. After this peak-to-peak inductor current ripple is chosen, use [Equation 10](#) to calculate the recommended value of the output inductor L.

$$L = \frac{V_{OUT} \times (V_{VIN(max)} - V_{OUT})}{V_{VIN(max)} \times K_{IND} \times I_{LED} \times f_{SW}} \quad (10)$$

where

- K_{IND} is a coefficient that represents the amount of inductor ripple current relative to the maximum LED current.
- I_{LED} is the maximum LED current.
- V_{OUT} is the sum of the voltage across LED load and the voltage across sense resistor.

With the chosen inductor value, the user can calculate the actual inductor-current ripple using [Equation 11](#).

$$I_{L(ripple)} = \frac{V_{OUT} \times (V_{VIN(max)} - V_{OUT})}{V_{VIN(max)} \times L \times f_{SW}} \quad (11)$$

In this design, $V_{IN(max)} = 26.4$ V, $V_{OUT} = 18.1$ V, $I_{LED} = 1$ A, choose $K_{IND} = 0.6$, the calculated inductance is 9.49 μ H. A 10- μ H inductor is chosen. With this inductor, the ripple, peak, and rms currents of the inductor are 0.57 A, 1.29 A, and 1.01 A, respectively.

8.2.2.2.2 Input Capacitor Selection

In this design, a 10- μ F, 35-V X7R ceramic capacitor, part number GRM32ER7YA106KA12L, from muRata is chosen. This ceramic capacitor yields around 30-mV input-ripple voltage.

8.2.2.2.3 Output Capacitor Selection

The dynamic resistance of this Cree white LED is 0.67 ohm at 1-A forward current. In this design, choose a 10- μ F, 35-V X7R ceramic capacitor, part number GRM32ER7YA106KA12L. The calculated ripple current of LED is about 11.5mA.

8.2.2.2.3.1 Sense Resistor Selection

The maximum LED current is 1 A, and the corresponding V_{REF} is 99 mV. Using [Equation 1](#), calculate the needed sense resistance at 99 m Ω . Pay close attention to the power consumption of the sense resistor in this design at 99 mW, and make sure the chosen resistor has enough margin in its power rating.

8.2.2.2.3.1.1 Other External Components Selection

See the [Other External Components Selection](#).

8.2.2.3 Application Curves

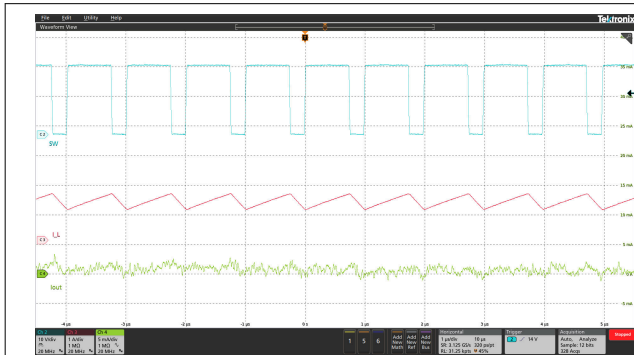

Blue: SW, Red: Inductor Current, Green: LED Current (AC)

Figure 8-14. LED Current Ripple at 100% Duty Cycle and 500 Hz

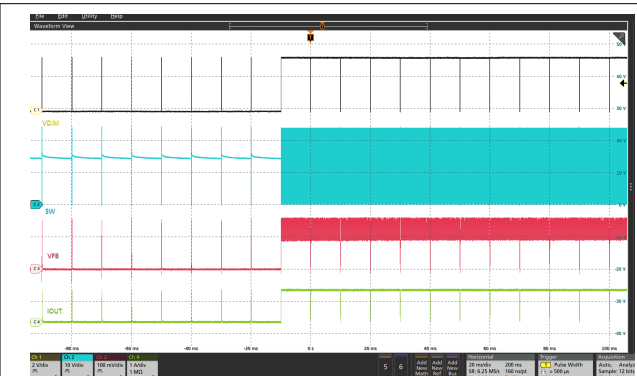

Black: DIM, Blue: SW, Red: FB, Green: LED Current

Figure 8-15. LED Current Transient From 1% to 100% Duty Cycle at 500 Hz

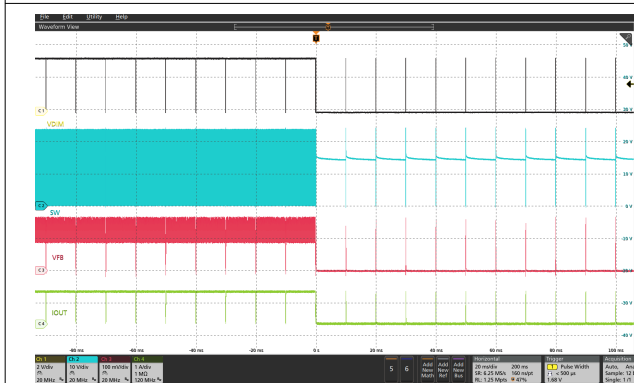

Black: DIM, Blue: SW, Red: FB, Green: LED Current

Figure 8-16. LED Current Transient From 100% to 1% Duty Cycle at 500 Hz

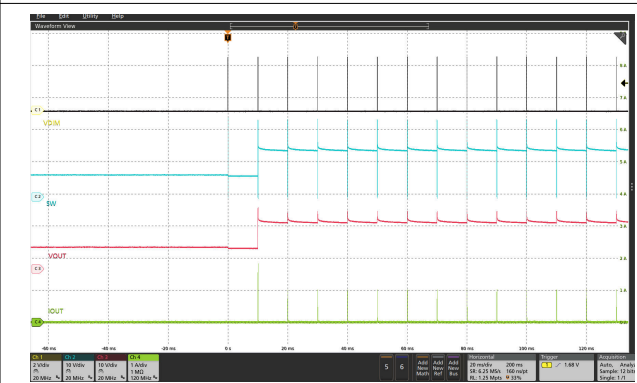

Black: DIM, Blue: SW, Red: VOUT, Green: LED Current

Figure 8-17. Start-Up at 1% Duty Cycle and 500 Hz

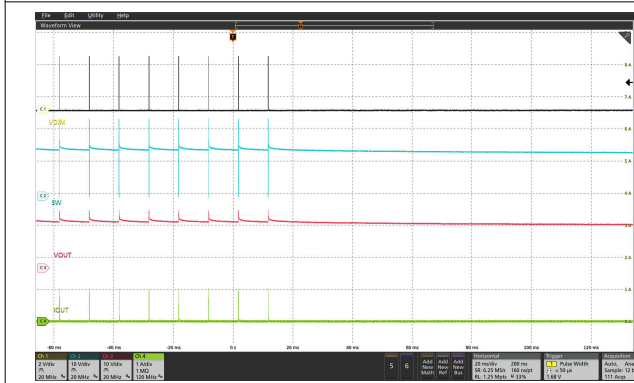

Black: DIM, Blue: SW, Red: VOUT, Green: LED Current

Figure 8-18. Shutdown at 1% Duty Cycle and 500 Hz

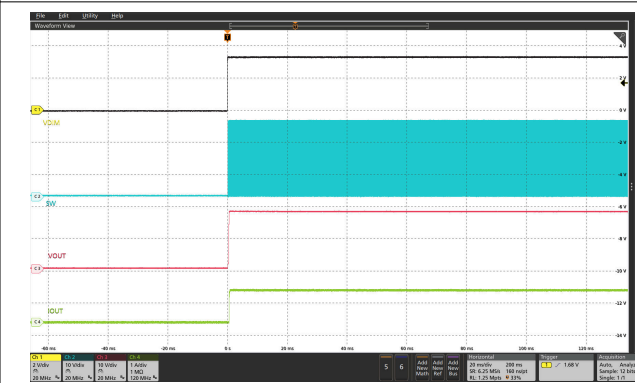

Black: DIM, Blue: SW, Red: VOUT, Green: LED Current

Figure 8-19. Start-Up at 100% Duty Cycle and 500 Hz

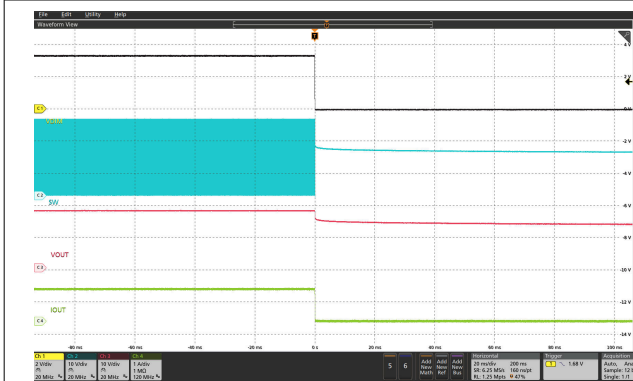
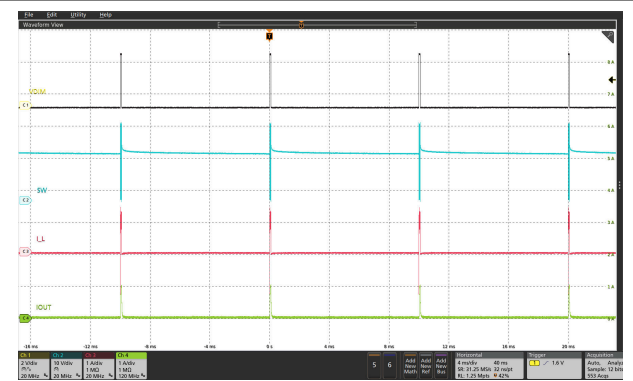
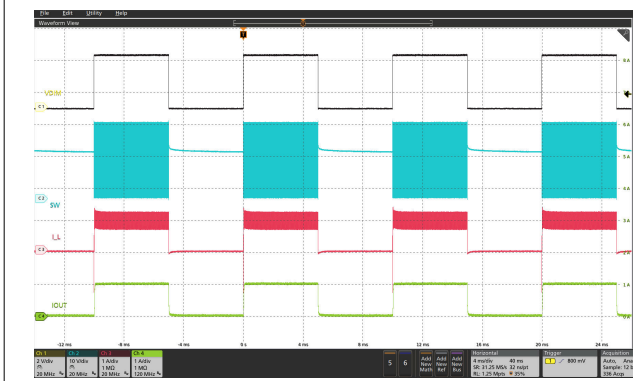

Figure 8-20. Shutdown at 100% Duty Cycle and 500 Hz



Black: DIM, Blue: SW, Red: Inductor Current, Green: LED Current
Figure 8-21. LED PWM Dimming at 1% Duty Cycle and 200 Hz



Black: DIM, Blue: SW, Red: Inductor Current, Green: LED Current
Figure 8-22. LED PWM Dimming at 50% Duty Cycle and 200 Hz

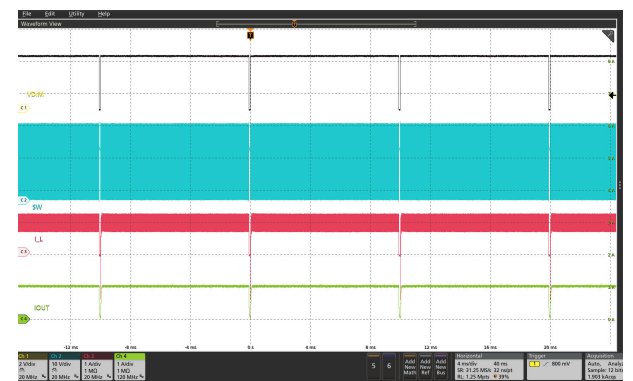

Black: DIM, Blue: SW, Red: Inductor Current, Green: LED Current
Figure 8-23. LED PWM Dimming at 99% Duty Cycle and 200 Hz

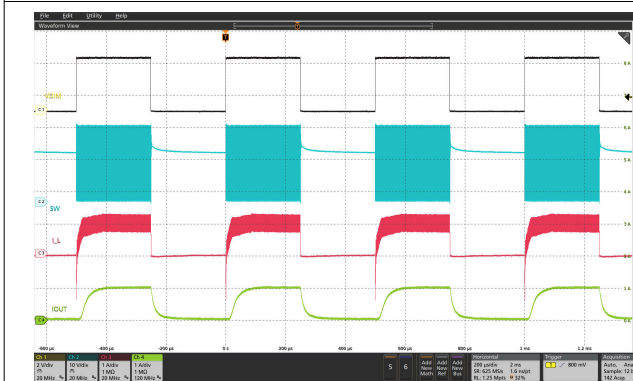

Black: DIM, Blue: SW, Red: Inductor Current, Green: LED Current
Figure 8-24. LED PWM Dimming at 50% Duty Cycle and 2 kHz

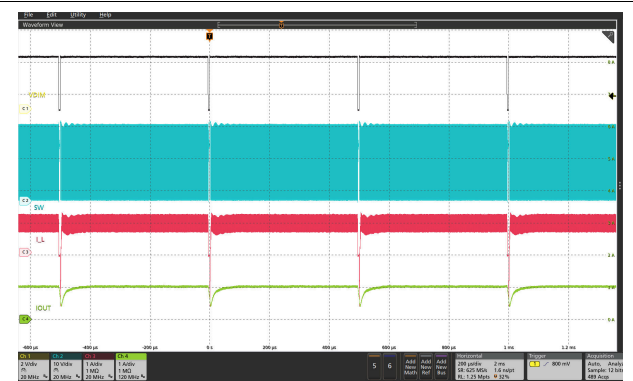

Black: DIM, Blue: SW, Red: Inductor Current, Green: LED Current
Figure 8-25. LED PWM Dimming at 99% Duty Cycle and 2 kHz

8.2.3 5-V Input, 1-A, 1-Piece IR LED Driver With TPS92200D2

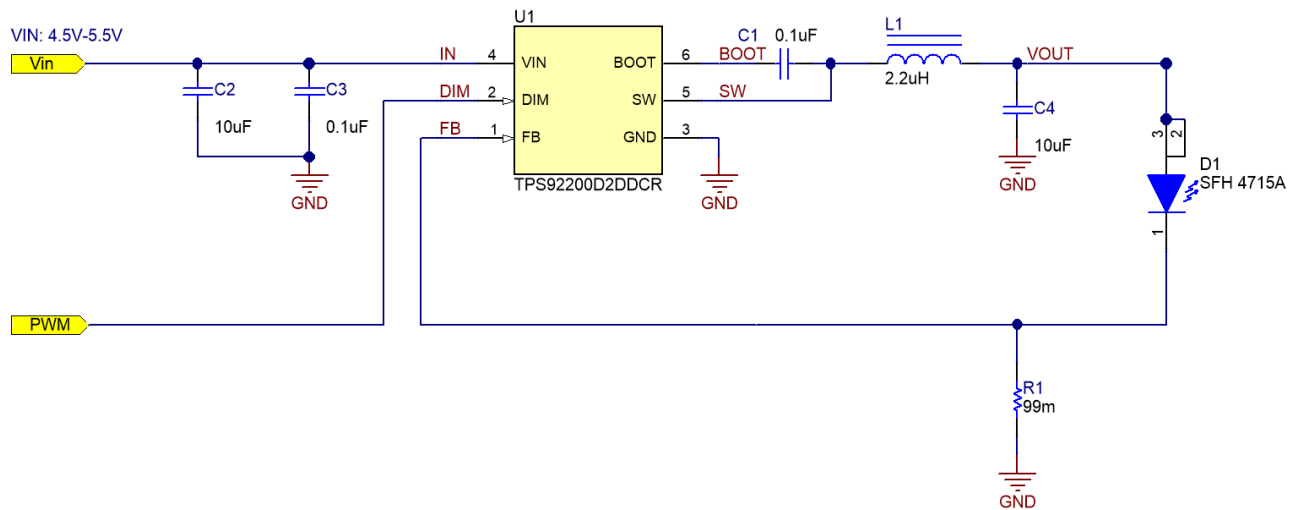

Figure 8-26. 5-VIN, 1-A, 1-piece IR LED, Analog Dimming Reference Design

8.2.3.1 Design Requirements

For this design example, use the parameters in the below table.

Table 8-3. Design Parameters

PARAMETER	VALUE
Input voltage range	5 V \pm 10%
LED forward voltage	1.75 V
Output voltage	1.85 V (1.75 + 0.1)
Maximum LED current	1 A
Inductor current ripple	60% of maximum LED current
LED current ripple	20 mA or less
Input voltage ripple	200 mV or less
Dimming type	Analog dimming with TPS92200D2: 50 kHz, 1% to 100 % duty cycle input on the DIM pin

8.2.3.2 Detailed Design Procedure

8.2.3.2.1 Inductor Selection

For this application, input voltage is 5-V rail with 10% variation, output is a single IR LED, and the inductor current ripple requirement is less than 60% of maximum LED current.

Use Equation 12 to calculate the minimum value of the output inductor (L_{MIN}).

$$L = \frac{V_{OUT} \times (V_{VIN(max)} - V_{OUT})}{V_{VIN(max)} \times K_{IND} \times I_{LED} \times f_{SW}} \quad (12)$$

where

- K_{IND} is a coefficient that represents the amount of inductor ripple current relative to the maximum LED current.
- I_{LED} is the maximum LED current.
- V_{OUT} is the sum of the voltage across LED load and the voltage across sense resistor.

With the chosen inductor value, the user can calculate the actual inductor current ripple using Equation 13.

$$I_{L(\text{ripple})} = \frac{V_{OUT} \times (V_{VIN(\text{max})} - V_{OUT})}{V_{VIN(\text{max})} \times L \times f_{SW}} \quad (13)$$

In this design, $V_{IN(\text{max})} = 5.5 \text{ V}$, $V_{OUT} = 1.85 \text{ V}$, $I_{LED} = 1 \text{ A}$, choose $K_{IND} = 0.6$. The calculated inductance is $2.046 \mu\text{H}$. A $2.2\text{-}\mu\text{H}$ inductor is chosen. With this inductor, the ripple, peak, and RMS currents of the inductor are 0.56 A , 1.28 A , and 1.01 A , respectively.

8.2.3.2.2 Input Capacitor Selection

In this design, a $10\text{-}\mu\text{F}$, 35-V X7R ceramic capacitor, part number GRM32ER7YA106KA12L, from muRata is chosen. This ceramic capacitor yields around 30-mV input ripple voltage.

8.2.3.2.3 Output Capacitor Selection

The dynamic resistance of this LED is 0.29 ohm at 1-A forward current. In this design, choose a $10\text{-}\mu\text{F}$, 35-V X7R ceramic capacitor, part number GRM32ER7YA106KA12. The calculated ripple current of LED is about 21.9 mA .

8.2.3.2.3.1 Sense Resistor Selection

The maximum LED current is 1 A , and the corresponding V_{REF} is 99 mV . Using [Equation 1](#), calculate the needed sense resistance at $99 \text{ m}\Omega$. Pay close attention to the power consumption of the sense resistor in this design at 99 mW , and make sure the chosen resistor has enough margin in its power rating.

8.2.3.2.3.1.1 Other External Components Selection

See the [Other External Components Selection](#) section.

8.2.3.3 Application Curves

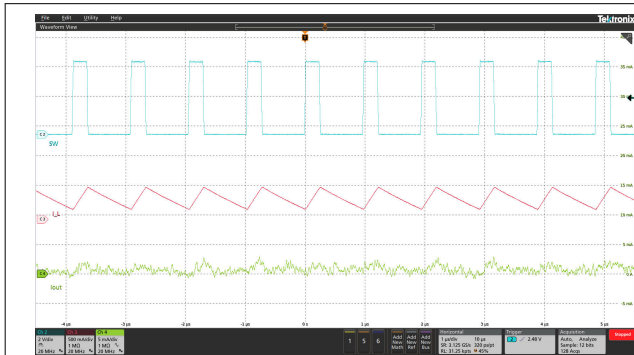

Blue: SW, Red: Inductor Current, Green: LED Current (AC)

Figure 8-27. LED Current Ripple at 1% Duty Cycle and 50 kHz

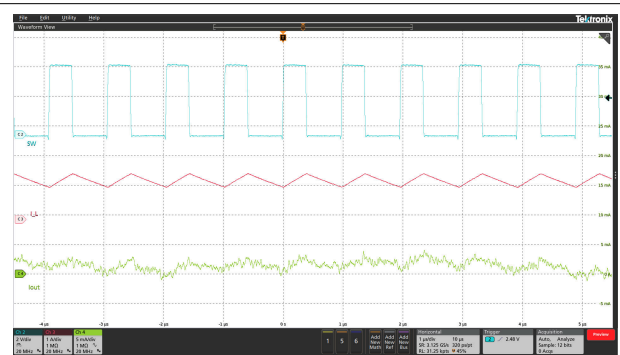

Blue: SW, Red: Inductor Current, Green: LED Current (AC)

Figure 8-28. LED Current Ripple at 100% Duty Cycle and 50 kHz

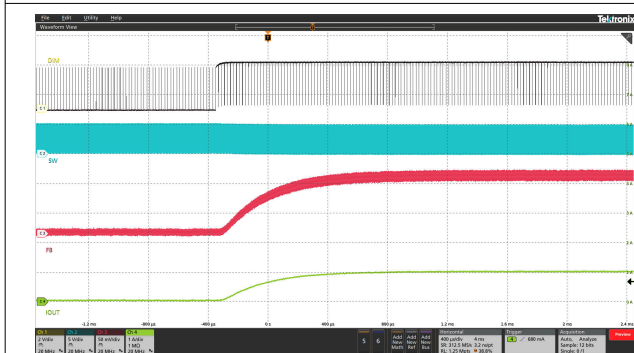

Black: DIM, Blue: SW, Red: FB, Green: LED Current

Figure 8-29. LED Current Transient From 1% to 100% Duty Cycle at 50 kHz

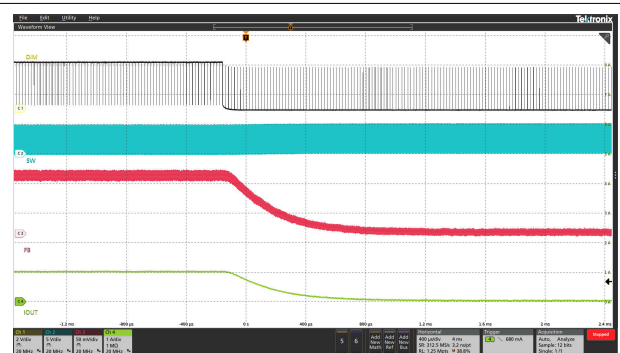

Black: DIM, Blue: SW, Red: FB, Green: LED Current

Figure 8-30. LED Current Transient From 100% to 1% Duty Cycle at 50 kHz

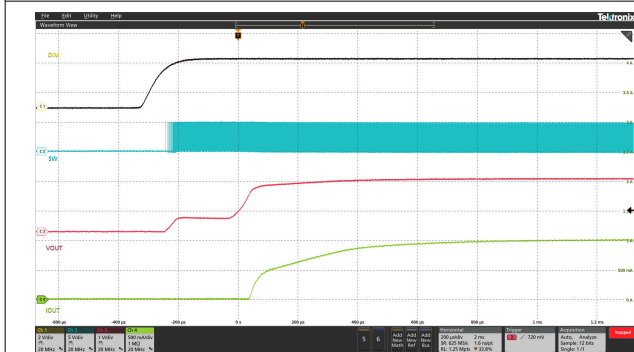

Black: DIM, Blue: SW, Red: VOUT, Green: LED Current

Figure 8-31. Start-Up at 100% Duty Cycle and 50 kHz

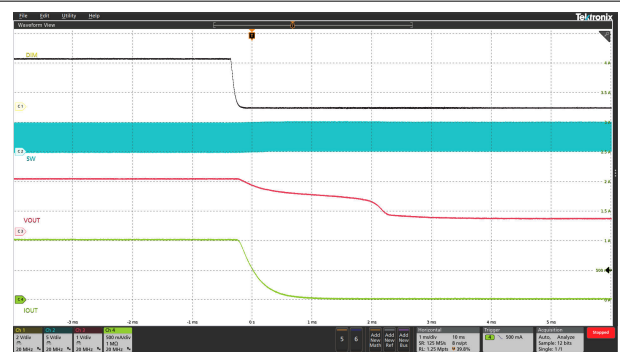

Black: DIM, Blue: SW, Red: VOUT, Green: LED Current

Figure 8-32. Shutdown at 100% Duty Cycle and 50 kHz

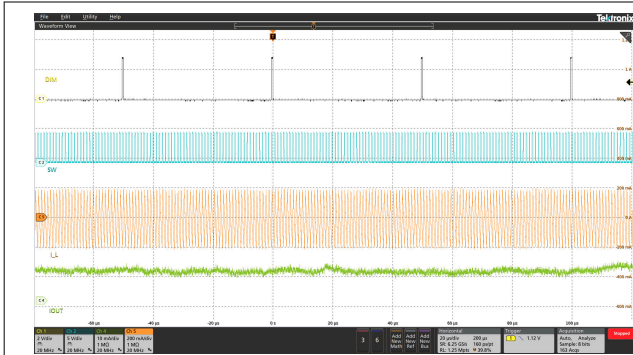

Black: DIM, Blue: SW, Orange: Inductor Current, Green: LED Current

Figure 8-33. LED Analog Dimming at 1% Duty Cycle and 20 kHz

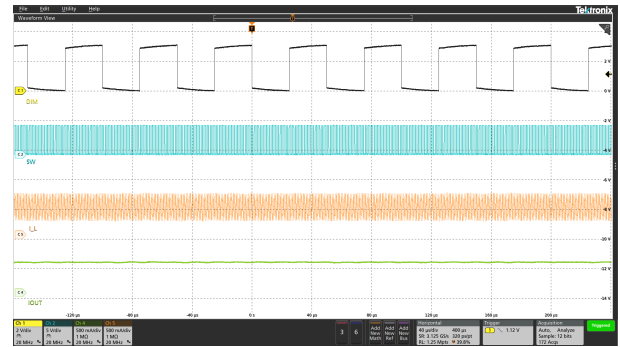

Black: DIM, Blue: SW, Orange: Inductor Current, Green: LED Current

Figure 8-34. LED Analog Dimming at 50% Duty Cycle and 20 kHz

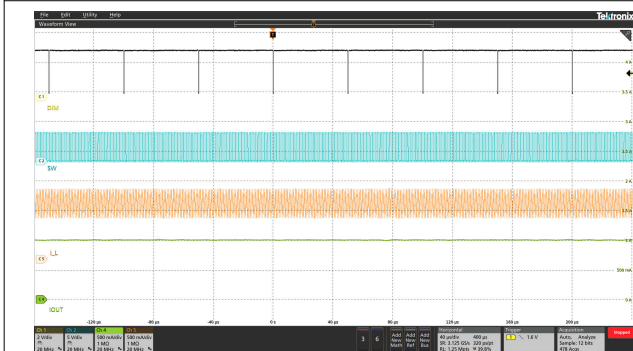

Black: DIM, Blue: SW, Orange: Inductor Current, Green: LED Current

Figure 8-35. LED Analog Dimming at 99% Duty Cycle and 20 kHz

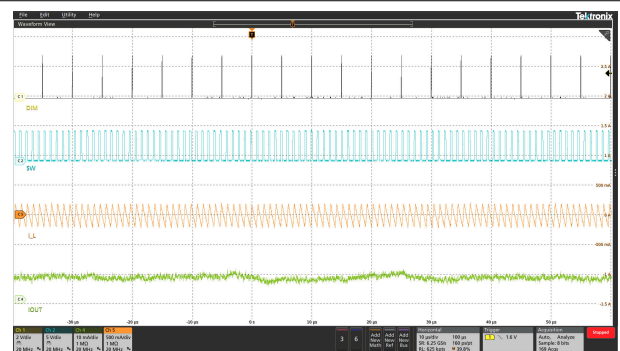

Black: DIM, Blue: SW, Orange: Inductor Current, Green: LED Current

Figure 8-36. LED Analog Dimming at 1% Duty Cycle and 200 kHz

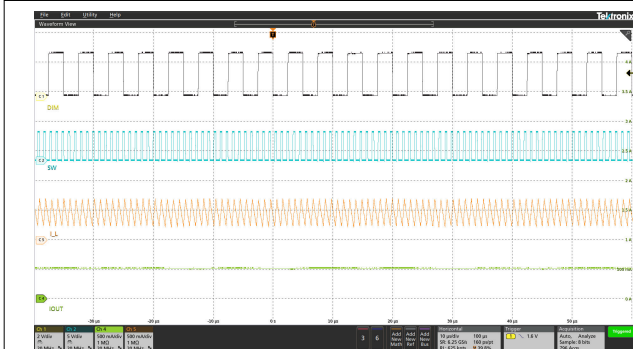

Black: DIM, Blue: SW, Orange: Inductor Current, Green: LED Current

Figure 8-37. LED Analog Dimming at 50% Duty Cycle and 200 kHz

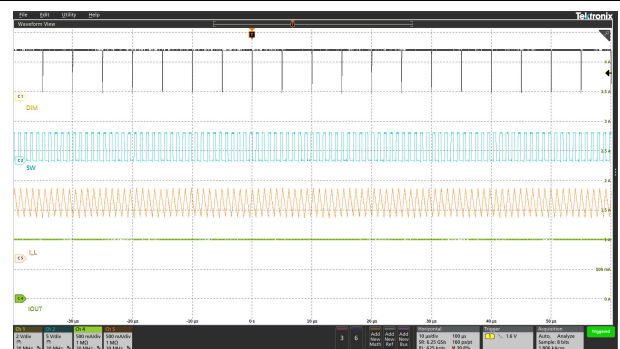

Black: DIM, Blue: SW, Orange: Inductor Current, Green: LED Current

Figure 8-38. LED Analog Dimming at 99% Duty Cycle and 200 kHz

9 Power Supply Recommendations

The devices are designed to operate from an input voltage supply range between 4 V and 30 V. This input supply must be well regulated. The device requires an input capacitor to reduce the surge current drawn from the input supply and the switching noise from the device. Ceramic capacitors with X5R or X7R dielectrics are highly recommended because of their low ESR and small temperature coefficients. For most applications, a 10- μ F capacitor is enough.

10 Layout

The TPS92200 device requires a proper layout for optimal performance. The following section gives some guidelines to ensure a proper layout.

10.1 Layout Guidelines

An example of a proper layout for the TPS92200 device is shown in [Figure 10-1](#).

- Creating a large GND plane for good electrical and thermal performance is important.
- The IN and GND traces must be as wide as possible to reduce trace impedance. Wide traces have the additional advantage of providing excellent heat dissipation.
- Thermal vias can be used to connect the top-side GND plane to additional printed-circuit board (PCB) layers for heat dissipation and grounding.
- The input capacitors must be located as close as possible to the IN pin and the GND pin.
- The SW trace must be kept as short as possible to reduce radiated noise and EMI.
- Do not allow switching current to flow under the device.
- The FB trace must be kept as short as possible and placed away from the high-voltage switching trace and the ground shield.
- In higher-current applications, routing the load current of the current-sense resistor to the junction of the input capacitor and GND node can be necessary.

10.2 Layout Example

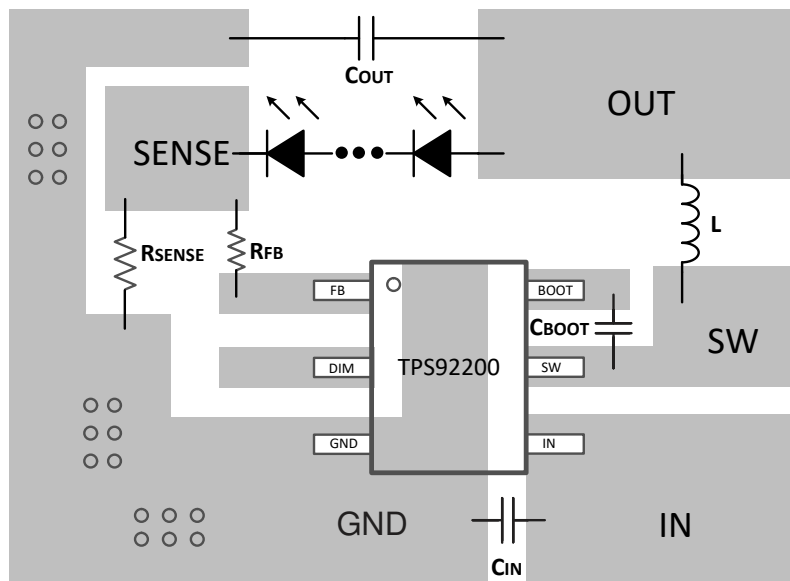

Figure 10-1. DDC Package Layout Example

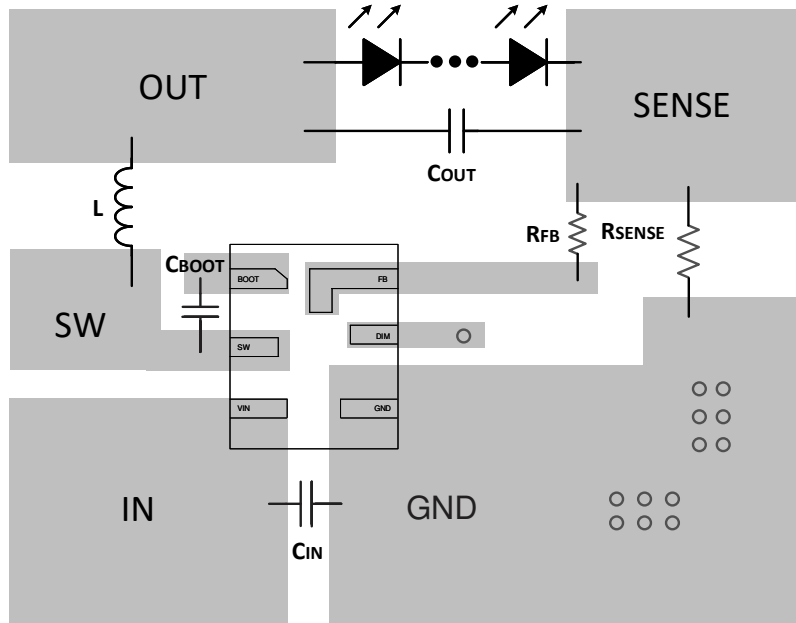

Figure 10-2. RXL Package Layout Example

11 Device and Documentation Support

11.1 Receiving Notification of Documentation Updates

To receive notification of documentation updates, navigate to the device product folder on ti.com. Click on *Subscribe to updates* to register and receive a weekly digest of any product information that has changed. For change details, review the revision history included in any revised document.

11.2 Support Resources

TI E2E™ [support forums](#) are an engineer's go-to source for fast, verified answers and design help — straight from the experts. Search existing answers or ask your own question to get the quick design help you need.

Linked content is provided "AS IS" by the respective contributors. They do not constitute TI specifications and do not necessarily reflect TI's views; see TI's [Terms of Use](#).

11.3 Trademarks

TI E2E™ is a trademark of Texas Instruments.

All trademarks are the property of their respective owners.

11.4 Electrostatic Discharge Caution



This integrated circuit can be damaged by ESD. Texas Instruments recommends that all integrated circuits be handled with appropriate precautions. Failure to observe proper handling and installation procedures can cause damage.

ESD damage can range from subtle performance degradation to complete device failure. Precision integrated circuits may be more susceptible to damage because very small parametric changes could cause the device not to meet its published specifications.

11.5 Glossary

[TI Glossary](#) This glossary lists and explains terms, acronyms, and definitions.

12 Mechanical, Packaging, and Orderable Information

The following pages include mechanical, packaging, and orderable information. This information is the most-current data available for the designated devices. This data is subject to change without notice and without revision of this document. For browser-based versions of this data sheet, see the left-hand navigation pane.



RXL0006A

PACKAGE OUTLINE

VQFN-HR - 1 mm max height

PLASTIC SMALL OUTLINE - NO LEAD

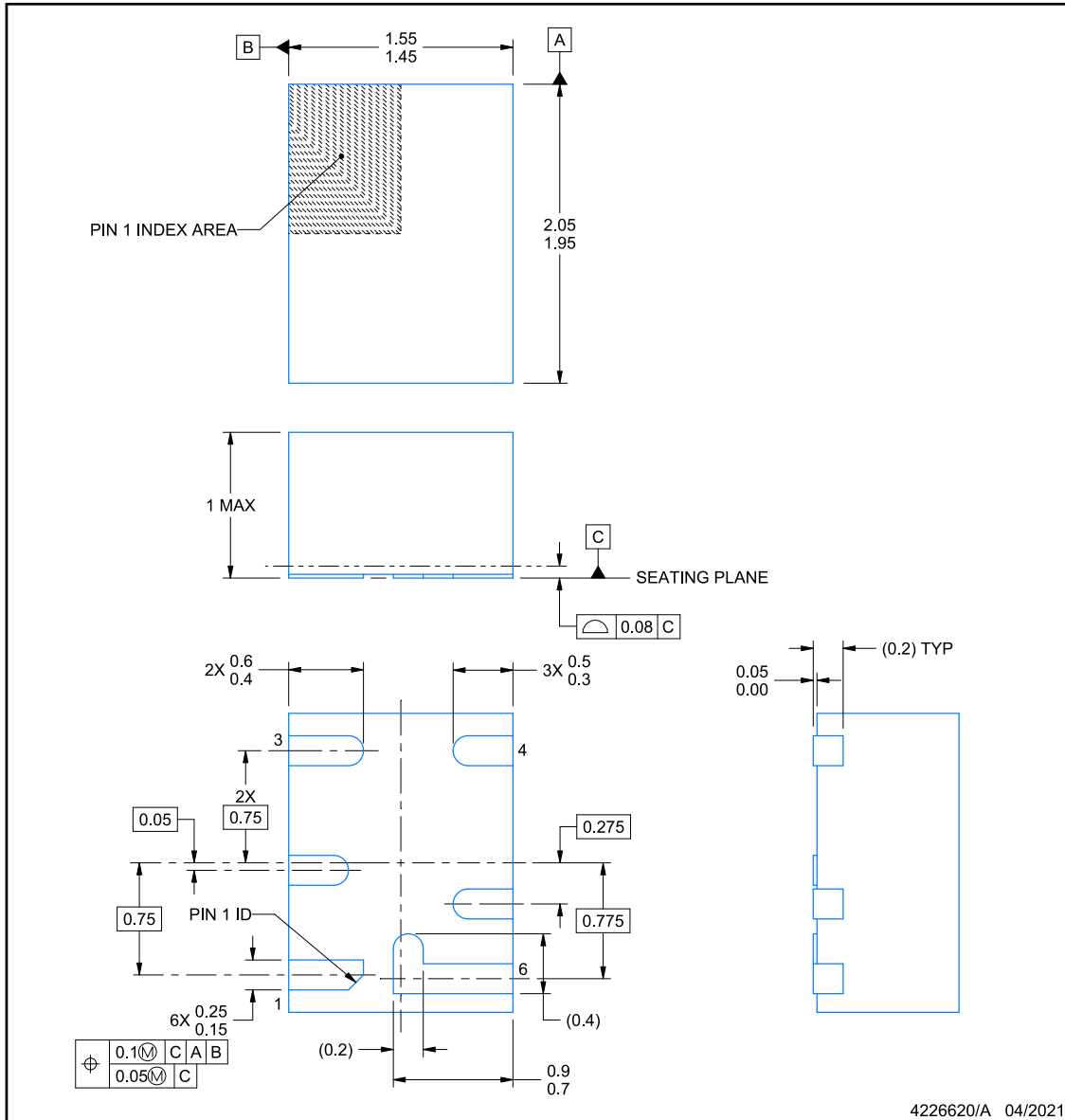

NOTES:

1. All linear dimensions are in millimeters. Any dimensions in parenthesis are for reference only. Dimensioning and tolerancing per ASME Y14.5M.
2. This drawing is subject to change without notice.

EXAMPLE BOARD LAYOUT

RXL0006A

VQFN-HR - 1 mm max height

PLASTIC SMALL OUTLINE - NO LEAD

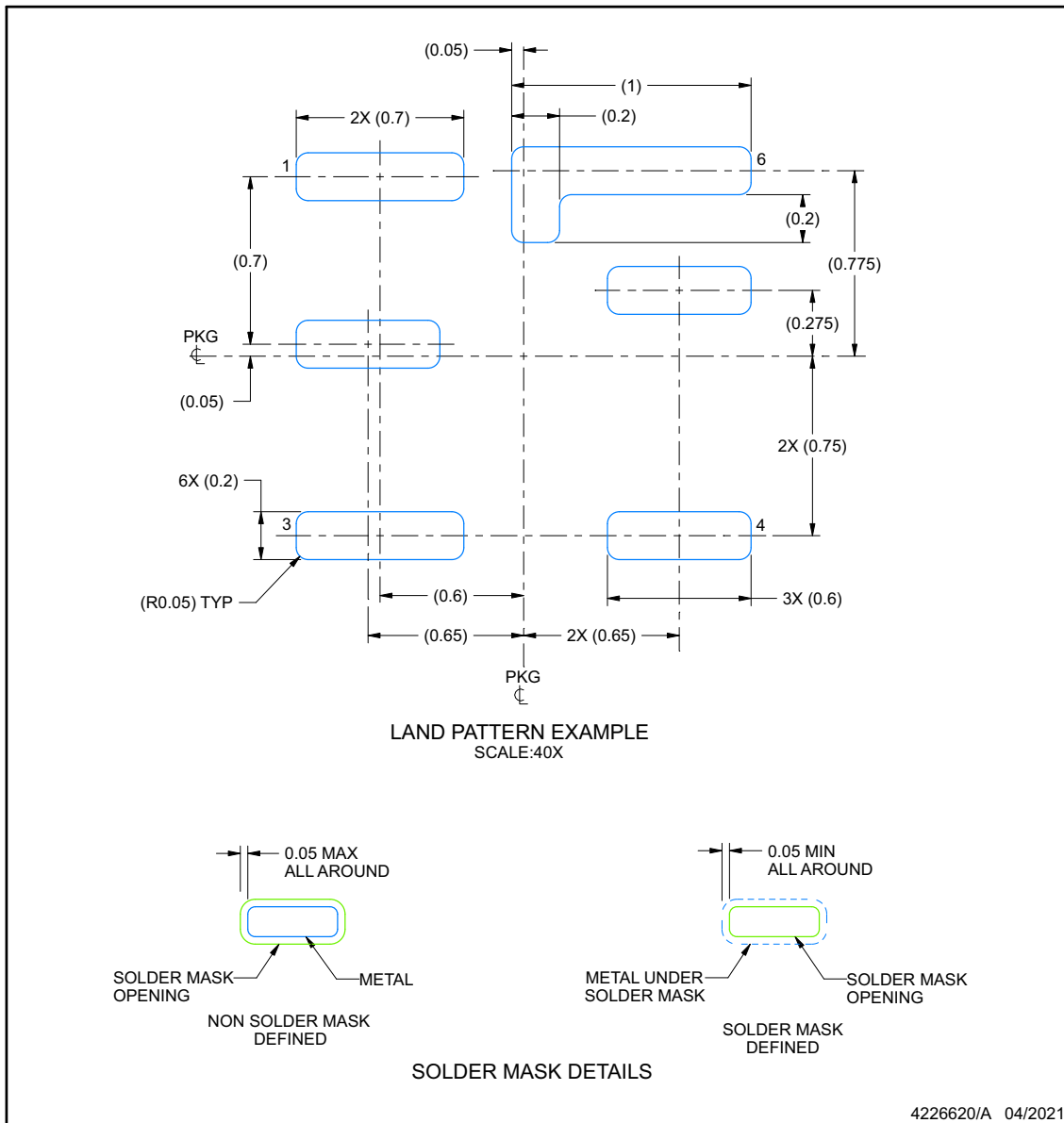

NOTES: (continued)

3. For more information, see Texas Instruments literature number SLUA271 (www.ti.com/lit/slua271).

EXAMPLE STENCIL DESIGN

RXL0006A

VQFN-HR - 1 mm max height

PLASTIC SMALL OUTLINE - NO LEAD

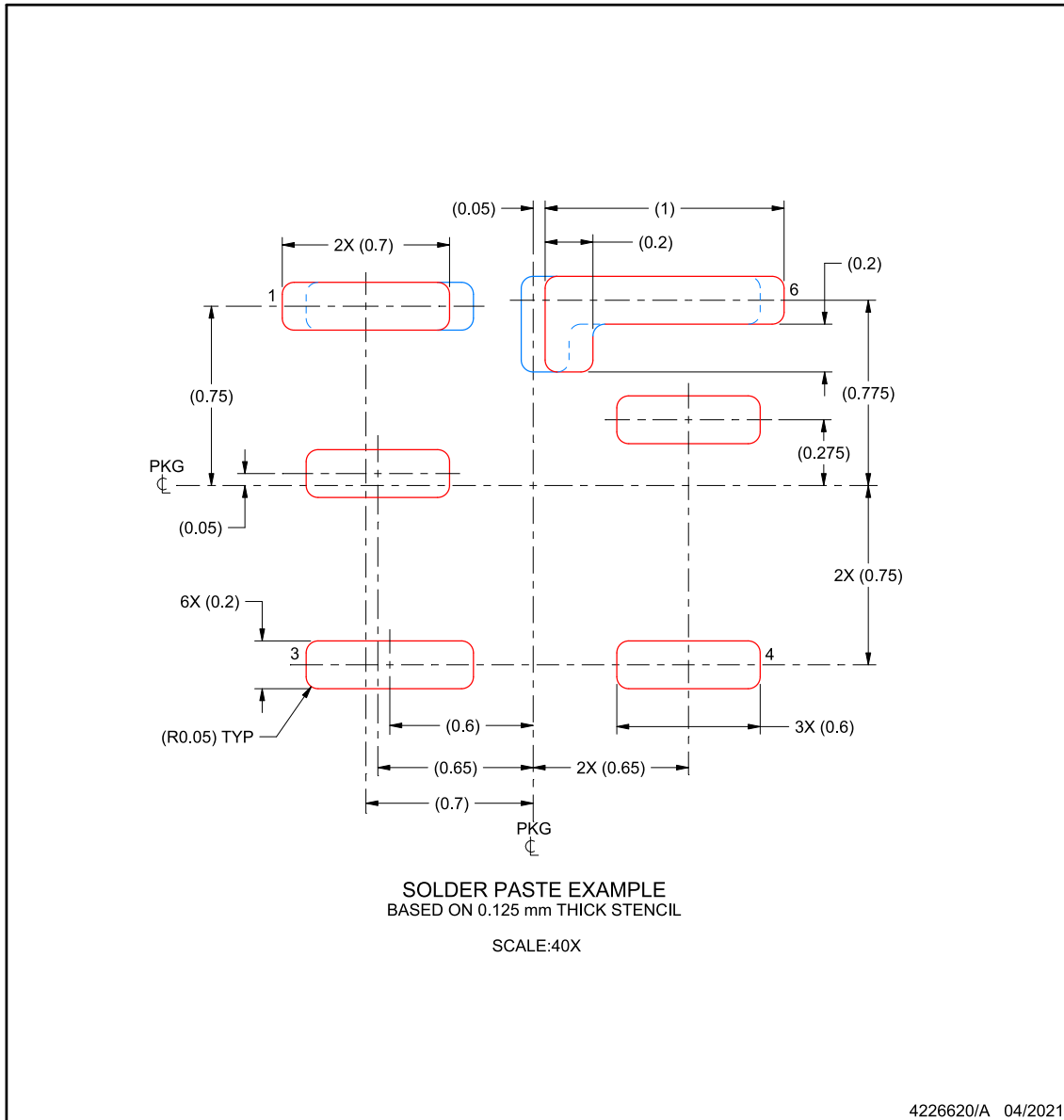

NOTES: (continued)

4. Laser cutting apertures with trapezoidal walls and rounded corners may offer better paste release. IPC-7525 may have alternate design recommendations.

PACKAGING INFORMATION

Orderable Device	Status (1)	Package Type	Package Drawing	Pins	Package Qty	Eco Plan (2)	Lead finish/ Ball material (6)	MSL Peak Temp (3)	Op Temp (°C)	Device Marking (4/5)	Samples
TPS92200D1DDCR	ACTIVE	SOT-23-THIN	DDC	6	3000	RoHS & Green	SN	Level-1-260C-UNLIM	-40 to 85	1SZK	Samples
TPS92200D1RXLR	ACTIVE	VQFN-HR	RXL	6	3000	RoHS & Green	NIPDAU	Level-2-260C-1 YEAR	-40 to 85	1JQ	Samples
TPS92200D2DDCR	ACTIVE	SOT-23-THIN	DDC	6	3000	RoHS & Green	SN	Level-1-260C-UNLIM	-40 to 85	1T1K	Samples
TPS92200D2RXLR	ACTIVE	VQFN-HR	RXL	6	3000	RoHS & Green	NIPDAU	Level-2-260C-1 YEAR	-40 to 85	1JP	Samples

(1) The marketing status values are defined as follows:

ACTIVE: Product device recommended for new designs.

LIFEBUY: TI has announced that the device will be discontinued, and a lifetime-buy period is in effect.

NRND: Not recommended for new designs. Device is in production to support existing customers, but TI does not recommend using this part in a new design.

PREVIEW: Device has been announced but is not in production. Samples may or may not be available.

OBSOLETE: TI has discontinued the production of the device.

(2) **RoHS:** TI defines "RoHS" to mean semiconductor products that are compliant with the current EU RoHS requirements for all 10 RoHS substances, including the requirement that RoHS substance do not exceed 0.1% by weight in homogeneous materials. Where designed to be soldered at high temperatures, "RoHS" products are suitable for use in specified lead-free processes. TI may reference these types of products as "Pb-Free".

RoHS Exempt: TI defines "RoHS Exempt" to mean products that contain lead but are compliant with EU RoHS pursuant to a specific EU RoHS exemption.

Green: TI defines "Green" to mean the content of Chlorine (Cl) and Bromine (Br) based flame retardants meet JS709B low halogen requirements of <=1000ppm threshold. Antimony trioxide based flame retardants must also meet the <=1000ppm threshold requirement.

(3) MSL, Peak Temp. - The Moisture Sensitivity Level rating according to the JEDEC industry standard classifications, and peak solder temperature.

(4) There may be additional marking, which relates to the logo, the lot trace code information, or the environmental category on the device.

(5) Multiple Device Markings will be inside parentheses. Only one Device Marking contained in parentheses and separated by a "-" will appear on a device. If a line is indented then it is a continuation of the previous line and the two combined represent the entire Device Marking for that device.

(6) Lead finish/Ball material - Orderable Devices may have multiple material finish options. Finish options are separated by a vertical ruled line. Lead finish/Ball material values may wrap to two lines if the finish value exceeds the maximum column width.

Important Information and Disclaimer: The information provided on this page represents TI's knowledge and belief as of the date that it is provided. TI bases its knowledge and belief on information provided by third parties, and makes no representation or warranty as to the accuracy of such information. Efforts are underway to better integrate information from third parties. TI has taken and

continues to take reasonable steps to provide representative and accurate information but may not have conducted destructive testing or chemical analysis on incoming materials and chemicals. TI and TI suppliers consider certain information to be proprietary, and thus CAS numbers and other limited information may not be available for release.

In no event shall TI's liability arising out of such information exceed the total purchase price of the TI part(s) at issue in this document sold by TI to Customer on an annual basis.

TAPE AND REEL INFORMATION

QUADRANT ASSIGNMENTS FOR PIN 1 ORIENTATION IN TAPE



*All dimensions are nominal

Device	Package Type	Package Drawing	Pins	SPQ	Reel Diameter (mm)	Reel Width W1 (mm)	A0 (mm)	B0 (mm)	K0 (mm)	P1 (mm)	W (mm)	Pin1 Quadrant
TPS92200D1DDCR	SOT-23-THIN	DDC	6	3000	180.0	9.5	3.17	3.1	1.1	4.0	8.0	Q3
TPS92200D1RXLR	VQFN-HR	RXL	6	3000	180.0	8.4	1.75	2.25	1.0	4.0	8.0	Q1
TPS92200D2DDCR	SOT-23-THIN	DDC	6	3000	180.0	9.5	3.17	3.1	1.1	4.0	8.0	Q3
TPS92200D2RXLR	VQFN-HR	RXL	6	3000	180.0	8.4	1.75	2.25	1.0	4.0	8.0	Q1

TAPE AND REEL BOX DIMENSIONS

*All dimensions are nominal

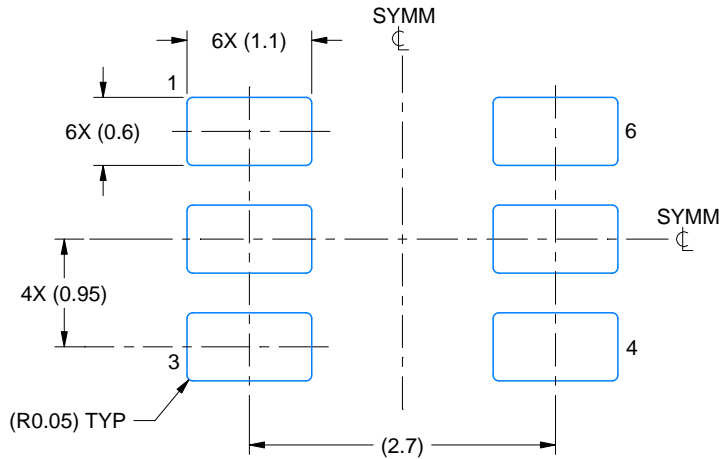
Device	Package Type	Package Drawing	Pins	SPQ	Length (mm)	Width (mm)	Height (mm)
TPS92200D1DDCR	SOT-23-THIN	DDC	6	3000	184.0	184.0	19.0
TPS92200D1RXLR	VQFN-HR	RXL	6	3000	210.0	185.0	35.0
TPS92200D2DDCR	SOT-23-THIN	DDC	6	3000	184.0	184.0	19.0
TPS92200D2RXLR	VQFN-HR	RXL	6	3000	210.0	185.0	35.0



LAND PATTERN EXAMPLE
EXPLODED METAL SHOWN
SCALE:15X



SOLDEMASK DETAILS

4214841/B 11/2020

NOTES: (continued)

- 4. Publication IPC-7351 may have alternate designs.
- 5. Solder mask tolerances between and around signal pads can vary based on board fabrication site.

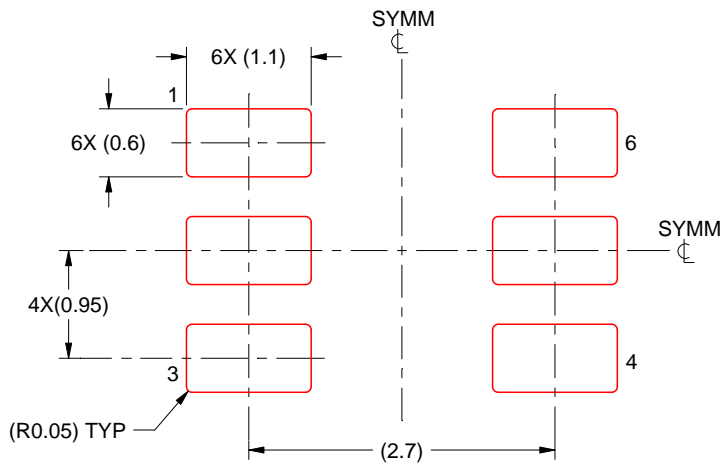

SOLDER PASTE EXAMPLE
 BASED ON 0.125 THICK STENCIL
 SCALE:15X

4214841/B 11/2020

NOTES: (continued)

- 6. Laser cutting apertures with trapezoidal walls and rounded corners may offer better paste release. IPC-7525 may have alternate design recommendations.
- 7. Board assembly site may have different recommendations for stencil design.

IMPORTANT NOTICE AND DISCLAIMER

TI PROVIDES TECHNICAL AND RELIABILITY DATA (INCLUDING DATA SHEETS), DESIGN RESOURCES (INCLUDING REFERENCE DESIGNS), APPLICATION OR OTHER DESIGN ADVICE, WEB TOOLS, SAFETY INFORMATION, AND OTHER RESOURCES "AS IS" AND WITH ALL FAULTS, AND DISCLAIMS ALL WARRANTIES, EXPRESS AND IMPLIED, INCLUDING WITHOUT LIMITATION ANY IMPLIED WARRANTIES OF MERCHANTABILITY, FITNESS FOR A PARTICULAR PURPOSE OR NON-INFRINGEMENT OF THIRD PARTY INTELLECTUAL PROPERTY RIGHTS.

These resources are intended for skilled developers designing with TI products. You are solely responsible for (1) selecting the appropriate TI products for your application, (2) designing, validating and testing your application, and (3) ensuring your application meets applicable standards, and any other safety, security, regulatory or other requirements.

These resources are subject to change without notice. TI grants you permission to use these resources only for development of an application that uses the TI products described in the resource. Other reproduction and display of these resources is prohibited. No license is granted to any other TI intellectual property right or to any third party intellectual property right. TI disclaims responsibility for, and you will fully indemnify TI and its representatives against, any claims, damages, costs, losses, and liabilities arising out of your use of these resources.

TI's products are provided subject to [TI's Terms of Sale](#) or other applicable terms available either on ti.com or provided in conjunction with such TI products. TI's provision of these resources does not expand or otherwise alter TI's applicable warranties or warranty disclaimers for TI products.

TI objects to and rejects any additional or different terms you may have proposed.

Mailing Address: Texas Instruments, Post Office Box 655303, Dallas, Texas 75265
Copyright © 2022, Texas Instruments Incorporated