

NTLTD7900ZR2

Power MOSFET

9 A, 20 V, Logic Level, N-Channel Micro8™ Leadless

This advanced Power MOSFET contains monolithic back-to-back Zener diodes. These Zener diodes provide protection against ESD and unexpected transients. These miniature surface mount MOSFETs feature ultra low $R_{DS(on)}$ and true logic level performance. This device is designed for use in low voltage, high speed switching applications where power efficiency is important. Typical applications are DC-DC converters, and power management in portable and battery powered products such as computers, printers, cellular and cordless phones.

Features

- Pb-Free Package is Available

Applications

- Zener Protected Gates Provide Electrostatic Discharge Protection
- Designed to Withstand 4000 V Human Body Model
- Ultra Low $R_{DS(on)}$ Provides Higher Efficiency and Extends Battery Life
- Logic Level Gate Drive - Can be Driven by Logic ICs
- Micro8 Leadless Surface Mount Package - Saves Board Space
- I_{DSS} Specified at Elevated Temperature

MAXIMUM RATINGS ($T_J = 25^\circ\text{C}$ unless otherwise noted)

Rating	Symbol	10 Sec	Steady State	Unit
Drain-to-Source Voltage	V_{DS}	20		V
Gate-to-Source Voltage	V_{GS}	± 12		V
Continuous Drain Current (Note 1) $T_A = 25^\circ\text{C}$ $T_A = 85^\circ\text{C}$	I_D	9.0 6.4	6.0 4.3	A
Pulsed Drain Current ($t_p \leq 10 \mu\text{s}$)	I_{DM}	30		A
Continuous Source-Diode Conduction (Note 1)	I_S	2.9	1.4	A
Total Power Dissipation (Note 1) $T_A = 25^\circ\text{C}$ $T_A = 85^\circ\text{C}$	P_D	3.2 1.7	1.5 0.79	W
Operating Junction and Storage Temperature Range	T_J, T_{stg}	-55 to 150		$^\circ\text{C}$
Thermal Resistance (Note 1) Junction-to-Ambient	$R_{\theta JA}$	38	82	$^\circ\text{C}/\text{W}$

Stresses exceeding Maximum Ratings may damage the device. Maximum Ratings are stress ratings only. Functional operation above the Recommended Operating Conditions is not implied. Extended exposure to stresses above the Recommended Operating Conditions may affect device reliability.

- When surface mounted to 1" x 1" FR-4 board.



ON Semiconductor®

<http://onsemi.com>

**9 AMPERES
20 VOLTS**

$R_{DS(on)} = 26 \text{ m}\Omega$
($V_{GS} = 4.5 \text{ V}, I_D = 6.5 \text{ A}$)

$R_{DS(on)} = 31 \text{ m}\Omega$
($V_{GS} = 2.5 \text{ V}, I_D = 5.8 \text{ A}$)

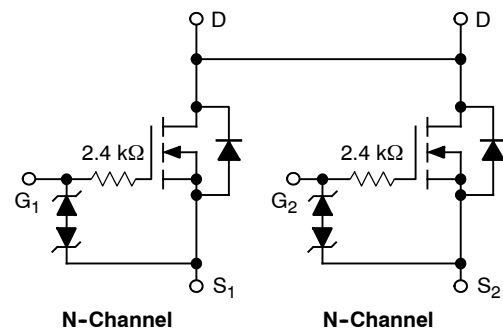

N-Channel

N-Channel

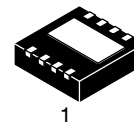

Micro8 LEADLESS
CASE 846C

MARKING DIAGRAM

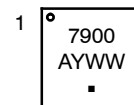

- A = Assembly Location
- Y = Year
- WW = Work Week
- = Pb-Free Package

PIN ASSIGNMENT

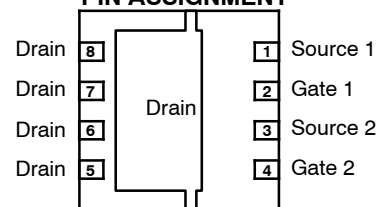

(Bottom View)

ORDERING INFORMATION

See detailed ordering and shipping information in the package dimensions section on page 6 of this data sheet.

NTLTD7900ZR2

ELECTRICAL CHARACTERISTICS (T_J = 25°C unless otherwise noted)

Characteristic	Symbol	Min	Typ	Max	Unit	
OFF CHARACTERISTICS						
Drain-to-Source Breakdown Voltage (Note 2) (V _{GS} = 0 Vdc, I _D = 250 μAdc)	V _{(BR)DSS}	20	24	-	Vdc	
Zero Gate Voltage Drain Current (V _{DS} = 16 Vdc, V _{GS} = 0 Vdc) (V _{DS} = 16 Vdc, V _{GS} = 0 Vdc, T _J = 85°C)	I _{DSS}	-	-	1.0 20	μAdc	
Gate-Body Leakage Current (V _{GS} = ±4.5 Vdc, V _{DS} = 0 Vdc) (V _{GS} = ±12 Vdc, V _{DS} = 0 Vdc)	I _{GSS}	-	-	1.0 500	μAdc μAdc	
ON CHARACTERISTICS (Note 2)						
Gate Threshold Voltage (Note 2) (V _{DS} = V _{GS} , I _D = 250 μAdc)	V _{GS(th)}	0.4	0.67	1.0	Vdc	
Static Drain-to-Source On-Resistance (Note 2) (V _{GS} = 4.5 Vdc, I _D = 6.5 Adc) (V _{GS} = 2.5 Vdc, I _D = 5.8 Adc)	R _{DS(on)}	-	21 27	26 31	mΩ	
DYNAMIC CHARACTERISTICS						
Input Capacitance	(V _{DS} = 16 Vdc, V _{GS} = 0 V, f = 1.0 MHz)	C _{iss}	-	7.4	15	pF
Output Capacitance		C _{oss}	-	237	400	
Transfer Capacitance		C _{rss}	-	4.1	10	pF
SWITCHING CHARACTERISTICS (Note 3)						
Turn-On Delay Time	(V _{GS} = 4.5 Vdc, V _{DD} = 10 Vdc, I _D = 1.0 Adc, R _G = 9.1 Ω) (Note 2)	t _{d(on)}	-	0.55	1.0	μs
Rise Time		t _r	-	1.17	2.0	
Turn-Off Delay Time		t _{d(off)}	-	1.87	3.0	
Fall Time		t _f	-	4.8	7.0	μs
Gate Charge	(V _{GS} = 4.5 Vdc, I _D = 6.5 Adc, V _{DS} = 10 Vdc) (Note 2)	Q _T	-	12	18	nC
Gate Charge		Q ₁	-	0.7	-	
		Q ₂	-	3.7	-	nC
SOURCE-DRAIN DIODE CHARACTERISTICS						
Forward On-Voltage	(I _S = 1.0 Adc, V _{GS} = 0 Vdc) I _S = 1.0 Adc, V _{GS} = 0 Vdc, T _J = 85°C) (Note 2)	V _{SD}	-	0.69 0.62	0.8 -	Vdc

2. Pulse Test: Pulse Width ≤ 300 μs, Duty Cycle ≤ 2%.

3. Switching characteristics are independent of operating junction temperatures.

TYPICAL ELECTRICAL CHARACTERISTICS

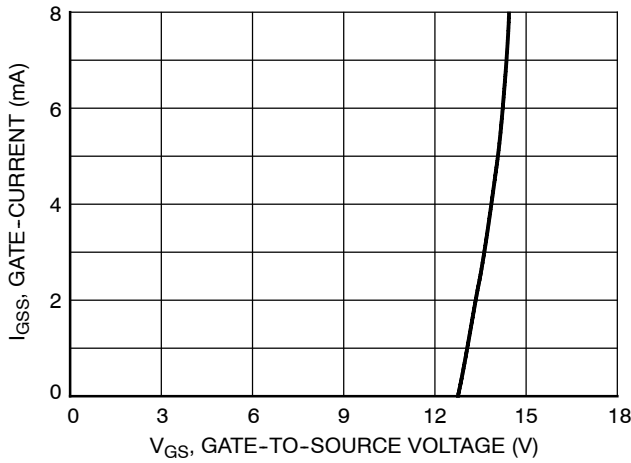

Figure 1. Gate-Current versus Gate-Source Voltage

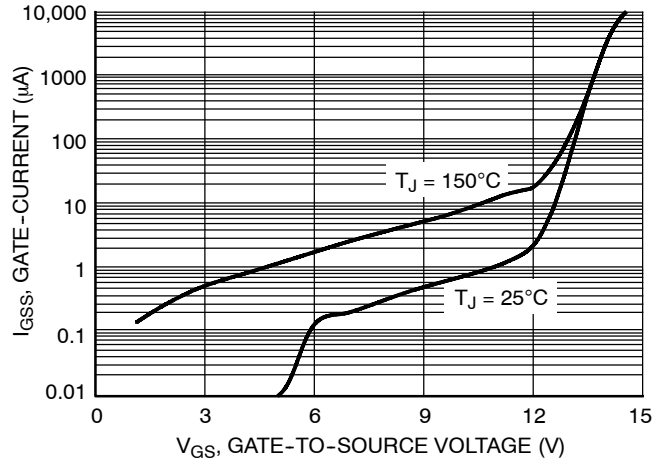

Figure 2. Gate-Current versus Gate-Source Voltage

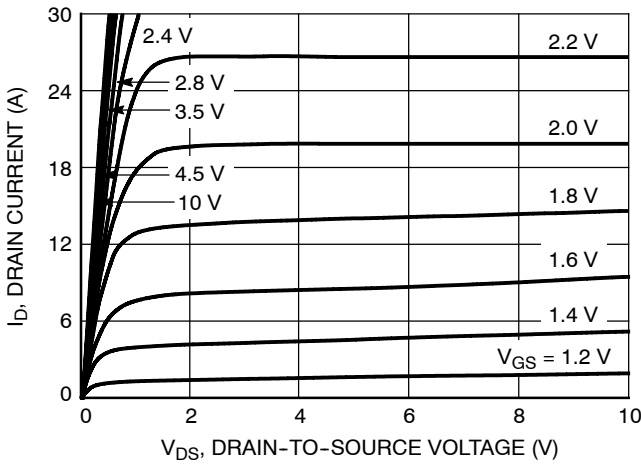

Figure 3. On-Region Characteristics

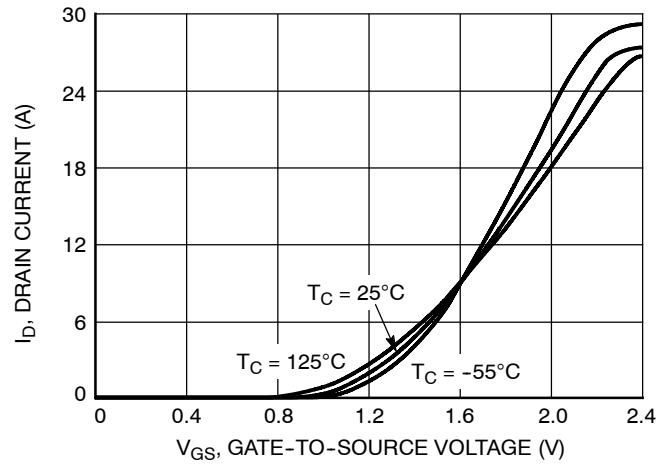

Figure 4. Transfer Characteristics

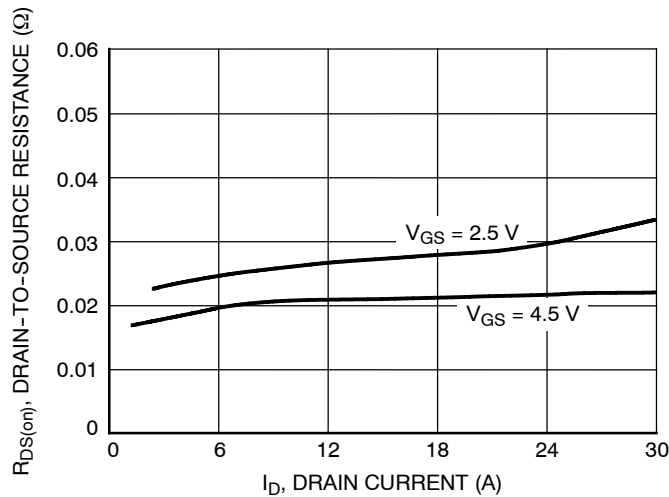

Figure 5. On-Resistance versus Drain Current

POWER MOSFET SWITCHING

Switching behavior is most easily modeled and predicted by recognizing that the power MOSFET is charge controlled. The lengths of various switching intervals (Δt) are determined by how fast the FET input capacitance can be charged by current from the generator.

The published capacitance data is difficult to use for calculating rise and fall because drain-gate capacitance varies greatly with applied voltage. Accordingly, gate charge data is used. In most cases, a satisfactory estimate of average input current ($I_{G(AV)}$) can be made from a rudimentary analysis of the drive circuit so that

$$t = Q/I_{G(AV)}$$

During the rise and fall time interval when switching a resistive load, V_{GS} remains virtually constant at a level known as the plateau voltage, V_{SGP} . Therefore, rise and fall times may be approximated by the following:

$$t_r = Q_2 \times R_G / (V_{GG} - V_{GSP})$$

$$t_f = Q_2 \times R_G / V_{GSP}$$

where

V_{GG} = the gate drive voltage, which varies from zero to V_{GG}

R_G = the gate drive resistance

and Q_2 and V_{GSP} are read from the gate charge curve.

During the turn-on and turn-off delay times, gate current is not constant. The simplest calculation uses appropriate values from the capacitance curves in a standard equation for voltage change in an RC network. The equations are:

$$t_{d(on)} = R_G C_{iss} \ln [V_{GG}/(V_{GG} - V_{GSP})]$$

$$t_{d(off)} = R_G C_{iss} \ln (V_{GG}/V_{GSP})$$

The capacitance (C_{iss}) is read from the capacitance curve at a voltage corresponding to the off-state condition when calculating $t_{d(on)}$ and is read at a voltage corresponding to the on-state when calculating $t_{d(off)}$.

At high switching speeds, parasitic circuit elements complicate the analysis. The inductance of the MOSFET source lead, inside the package and in the circuit wiring which is common to both the drain and gate current paths, produces a voltage at the source which reduces the gate drive current. The voltage is determined by $L di/dt$, but since di/dt is a function of drain current, the mathematical solution is complex. The MOSFET output capacitance also complicates the mathematics. And finally, MOSFETs have finite internal gate resistance which effectively adds to the resistance of the driving source, but the internal resistance is difficult to measure and, consequently, is not specified.

The resistive switching time variation versus gate resistance (Figure 8) shows how typical switching performance is affected by the parasitic circuit elements. If the parasitics were not present, the slope of the curves would maintain a value of unity regardless of the switching speed. The circuit used to obtain the data is constructed to minimize common inductance in the drain and gate circuit loops and is believed readily achievable with board mounted components. Most power electronic loads are inductive; the data in the figure is taken with a resistive load, which approximates an optimally snubbed inductive load. Power MOSFETs may be safely operated into an inductive load; however, snubbing reduces switching losses.

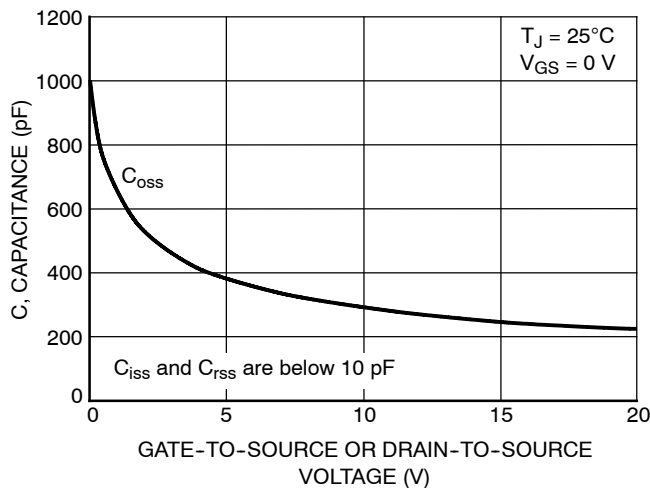

Figure 6. Capacitance Variation

NTLTD7900ZR2

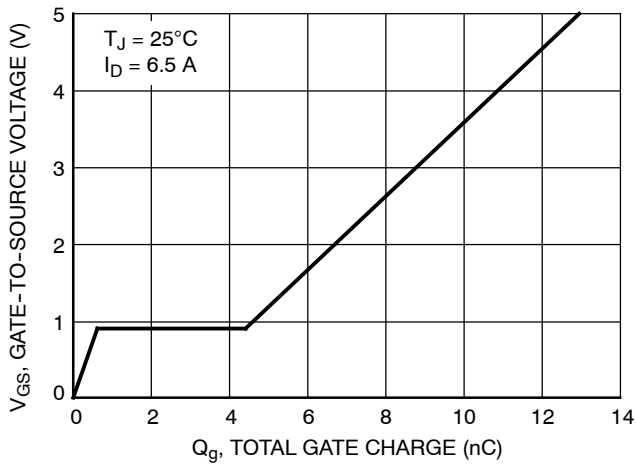

Figure 7. Gate-to-Source

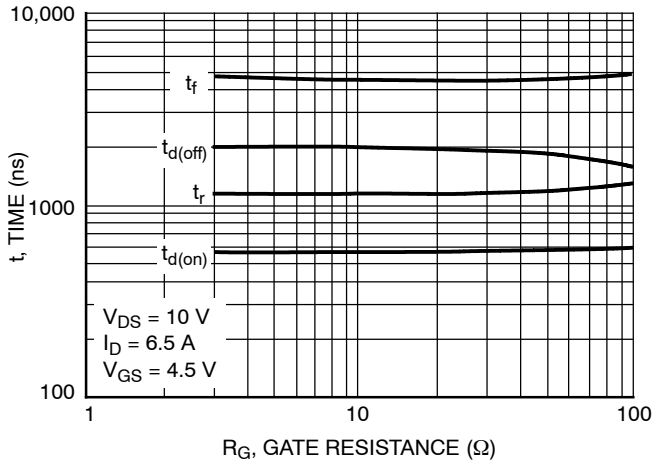

Figure 8. Resistive Switching Time Variation versus Gate Resistance

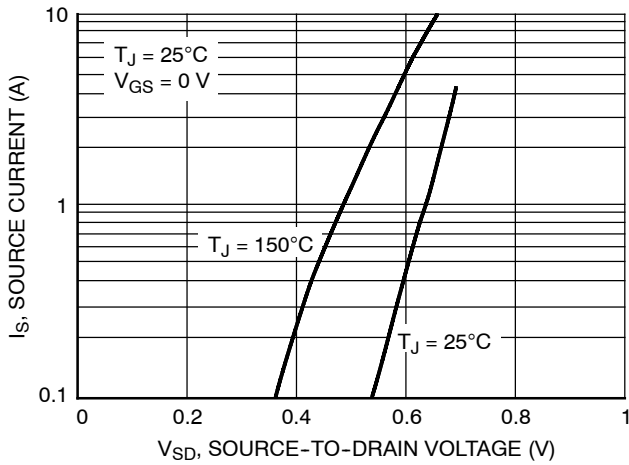

Figure 9. Diode Forward Voltage versus Current

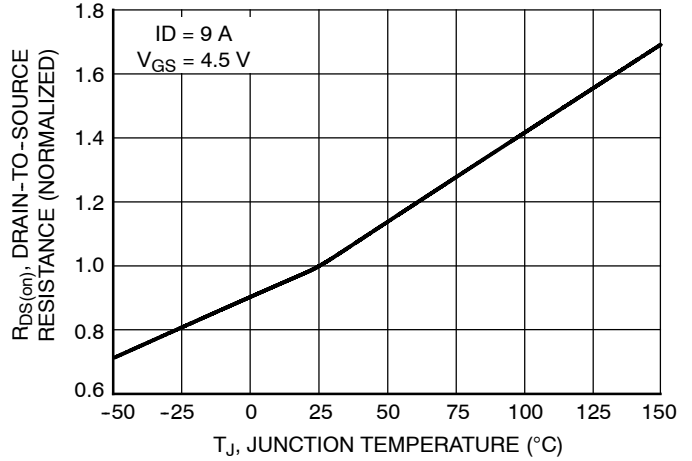

Figure 10. On-Resistance Variation with Temperature

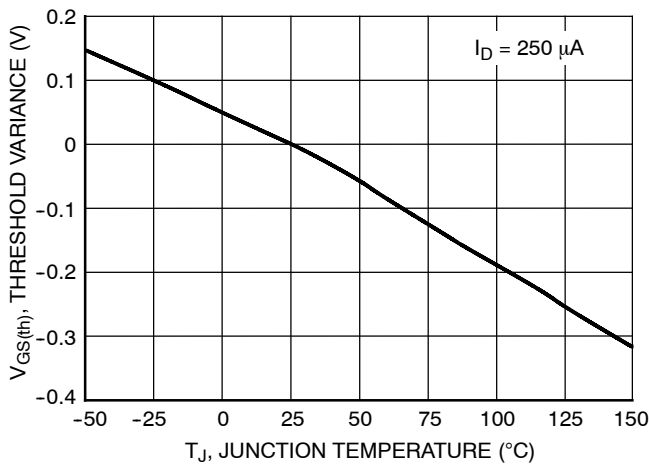

Figure 11. Threshold Voltage

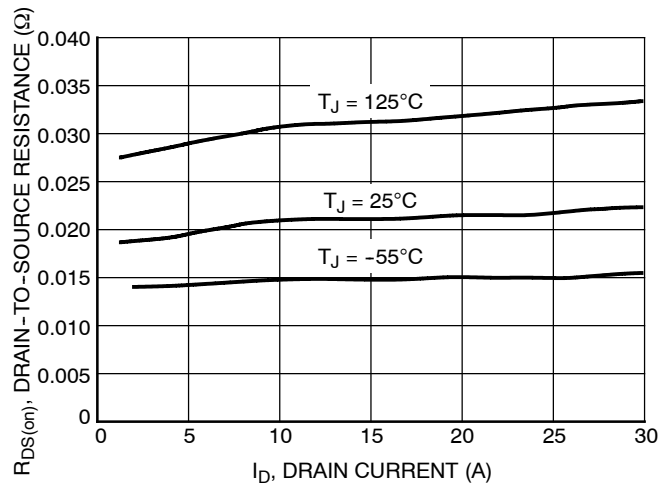

Figure 12. On-Resistance versus Drain Current and Temperature

NTLTD7900ZR2

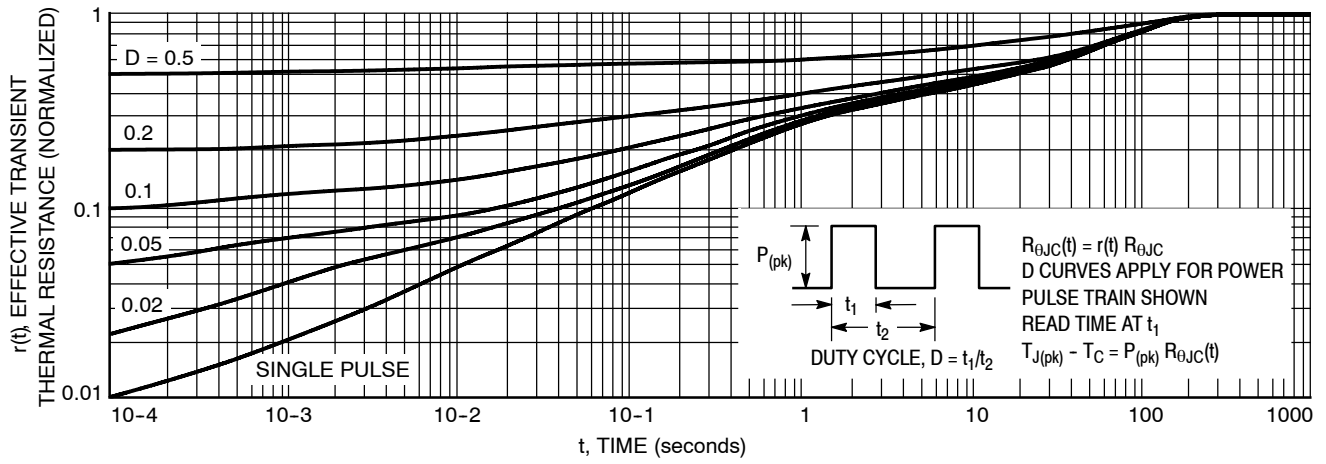

Figure 13. Thermal Response

ORDERING INFORMATION

Device	Package	Shipping [†]
NTLTD7900ZR2	Micro8 LL	3000 / Tape & Reel
NTLTD7900ZR2G	Micro8 LL (Pb-Free)	3000 / Tape & Reel

[†]For information on tape and reel specifications, including part orientation and tape sizes, please refer to our Tape and Reel Packaging Specifications Brochure, BRD8011/D.

MECHANICAL CASE OUTLINE

PACKAGE DIMENSIONS

ON Semiconductor®

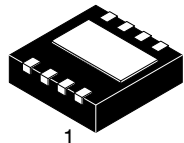

DFN8 3x3, (MICRO8 LEADLESS)

CASE 846C-01
ISSUE D

DATE 28 JUN 2010

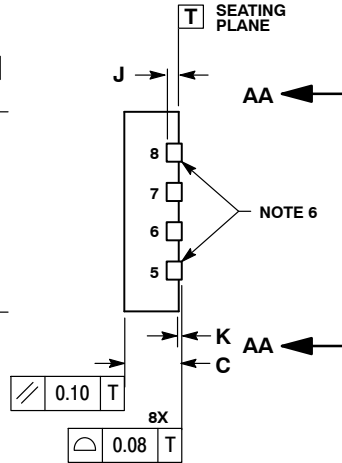
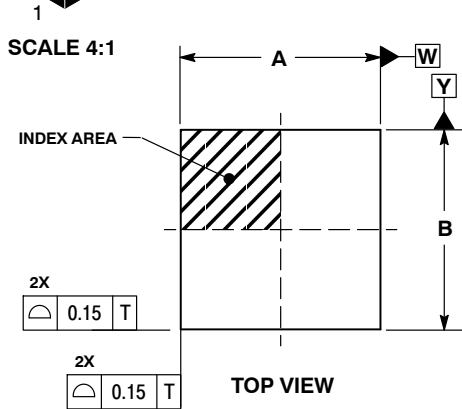

NOTES:

- DIMENSIONS AND TOLERANCING PER ASME Y14.5M, 1994.
- CONTROLLING DIMENSION: MILLIMETER.
- THE TERMINAL #1 IDENTIFIER AND TERMINAL NUMBERING CONVENTION SHALL CONFORM TO JESD 95-1 SPP-012. DETAILS OF TERMINAL #1 IDENTIFIER ARE OPTIONAL, BUT MUST BE LOCATED WITHIN THE ZONE INDICATED. THE TERMINAL #1 IDENTIFIER MAY BE EITHER A MOLD OR MARKED FEATURE.
- DIMENSION D APPLIES TO METALLIZED TERMINAL AND IS MEASURED BETWEEN 0.25 MM AND 0.30 MM FROM TERMINAL TIP. DIMENSION L1 IS THE TERMINAL PULL BACK FROM PACKAGE EDGE, UP TO 0.1 MM IS ACCEPTABLE. L1 IS OPTIONAL.
- DEPOPULATION IS POSSIBLE IN A SYMMETRICAL FASHION.
- OPTIONAL SIDE VIEW CAN SHOW LEADS 5 AND 8 REMOVED.

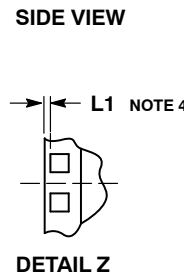
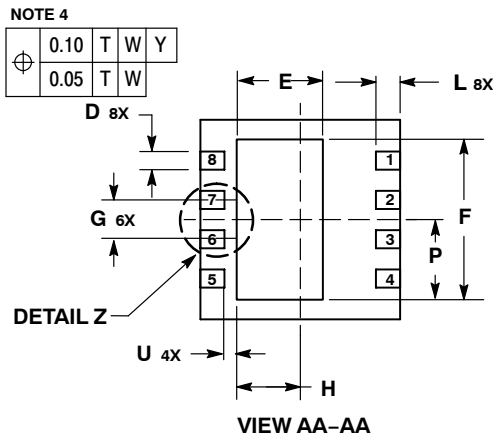

DIM	MILLIMETERS	
	MIN	MAX
A	3.30	BSC
B	3.30	BSC
C	0.85	0.95
D	0.25	0.35
E	1.30	1.50
F	2.55	2.75
G	0.65	BSC
H	0.95	1.15
J	0.25	BSC
K	0.00	0.05
L	0.35	0.45
L1	0.00	0.10
P	1.28	1.38
U	0.17	TYP

GENERIC MARKING DIAGRAM*

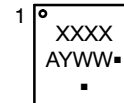

- XXXX = Specific Device Code
 A = Assembly Location
 Y = Year
 WW = Work Week
 ▪ = Pb-Free Package

(Note: Microdot may be in either location)

*This information is generic. Please refer to device data sheet for actual part marking. Pb-Free indicator, "G" or microdot "▪", may or may not be present.

SOLDERING FOOTPRINT*

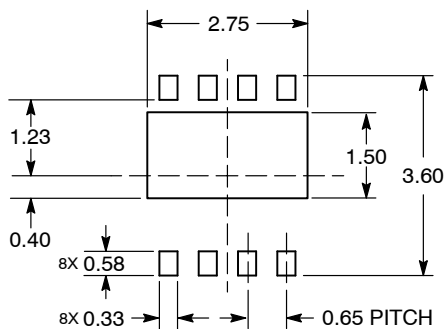

DIMENSIONS: MILLIMETERS

*For additional information on our Pb-Free strategy and soldering details, please download the ON Semiconductor Soldering and Mounting Techniques Reference Manual, SOLDERRM/D.

DOCUMENT NUMBER:	98AON11449D	Electronic versions are uncontrolled except when accessed directly from the Document Repository. Printed versions are uncontrolled except when stamped "CONTROLLED COPY" in red.
DESCRIPTION:	DFN8 3X3, (MICRO8 LEADLESS)	PAGE 1 OF 1

ON Semiconductor and ON are trademarks of Semiconductor Components Industries, LLC dba ON Semiconductor or its subsidiaries in the United States and/or other countries. ON Semiconductor reserves the right to make changes without further notice to any products herein. ON Semiconductor makes no warranty, representation or guarantee regarding the suitability of its products for any particular purpose, nor does ON Semiconductor assume any liability arising out of the application or use of any product or circuit, and specifically disclaims any and all liability, including without limitation special, consequential or incidental damages. ON Semiconductor does not convey any license under its patent rights nor the rights of others.

onsemi, **Onsemi**, and other names, marks, and brands are registered and/or common law trademarks of Semiconductor Components Industries, LLC dba "**onsemi**" or its affiliates and/or subsidiaries in the United States and/or other countries. **onsemi** owns the rights to a number of patents, trademarks, copyrights, trade secrets, and other intellectual property. A listing of **onsemi**'s product/patent coverage may be accessed at www.onsemi.com/site/pdf/Patent-Marking.pdf. **onsemi** reserves the right to make changes at any time to any products or information herein, without notice. The information herein is provided "as-is" and **onsemi** makes no warranty, representation or guarantee regarding the accuracy of the information, product features, availability, functionality, or suitability of its products for any particular purpose, nor does **onsemi** assume any liability arising out of the application or use of any product or circuit, and specifically disclaims any and all liability, including without limitation special, consequential or incidental damages. Buyer is responsible for its products and applications using **onsemi** products, including compliance with all laws, regulations and safety requirements or standards, regardless of any support or applications information provided by **onsemi**. "Typical" parameters which may be provided in **onsemi** data sheets and/or specifications can and do vary in different applications and actual performance may vary over time. All operating parameters, including "Typicals" must be validated for each customer application by customer's technical experts. **onsemi** does not convey any license under any of its intellectual property rights nor the rights of others. **onsemi** products are not designed, intended, or authorized for use as a critical component in life support systems or any FDA Class 3 medical devices or medical devices with a same or similar classification in a foreign jurisdiction or any devices intended for implantation in the human body. Should Buyer purchase or use **onsemi** products for any such unintended or unauthorized application, Buyer shall indemnify and hold **onsemi** and its officers, employees, subsidiaries, affiliates, and distributors harmless against all claims, costs, damages, and expenses, and reasonable attorney fees arising out of, directly or indirectly, any claim of personal injury or death associated with such unintended or unauthorized use, even if such claim alleges that **onsemi** was negligent regarding the design or manufacture of the part. **onsemi** is an Equal Opportunity/Affirmative Action Employer. This literature is subject to all applicable copyright laws and is not for resale in any manner.

PUBLICATION ORDERING INFORMATION

LITERATURE FULFILLMENT:

Email Requests to: orderlit@onsemi.com

onsemi Website: www.onsemi.com

TECHNICAL SUPPORT

North American Technical Support:

Voice Mail: 1 800-282-9855 Toll Free USA/Canada

Phone: 011 421 33 790 2910

Europe, Middle East and Africa Technical Support:

Phone: 00421 33 790 2910

For additional information, please contact your local Sales Representative